

TABLE OF CONTENTS

SECTION		PAGE
1	INTRODUCTION	3
2	THINGS TO KNOW BEFORE STARTING YOUR VEHICLE	9
3	UNDERSTANDING THE FEATURES OF YOUR VEHICLE	67
4	UNDERSTANDING YOUR INSTRUMENT PANEL	159
5	STARTING AND OPERATING	227
6	WHAT TO DO IN EMERGENCIES	295
7	MAINTAINING YOUR VEHICLE	307
8	MAINTENANCE SCHEDULES	361
9	IF YOU NEED CONSUMER ASSISTANCE	383
10	INDEX	391

INTRODUCTION

CONTENTS

■ Introduction	4	■ Warnings And Cautions	6
□ Roll Over Warning	4	■ Vehicle Identification Number	7
■ How To Use This Manual	6	■ Vehicle Modifications / Alterations	8

4 INTRODUCTION

INTRODUCTION

Thank you for selecting a Jeep® Grand Cherokee and welcome to our worldwide family.

This is a specialized utility vehicle designed for both on-road and off-road use. It can go places and perform tasks for which conventional two-wheel drive vehicles were not intended. However, on-road ride and handling will have a different feel from what drivers experience with other vehicles, so take time to become familiar with your vehicle.

The two-wheel drive utility vehicle was designed for on-road use only. It is not intended for off-road driving or use in other severe conditions suited to a four-wheel drive vehicle.

Before you start to drive this vehicle, read this manual. Be sure you are familiar with all vehicle controls, particularly those used for braking, steering and transmission and transfer case shifting. Learn how your vehicle

handles on different road surfaces. Your driving skills will improve with experience. When driving off-road or working the vehicle, don't overload it or expect it to overcome the laws of nature. Always observe federal, state, provincial, and local laws wherever you drive.

As with other vehicles of this type, failure to operate this vehicle correctly may result in loss of control or an accident. Be sure to read "On-Road/Off-Road Driving Tips" in Section 5 of this manual.

Roll Over Warning

Utility vehicles have a significantly higher roll over rate than other types of vehicles. This vehicle has a higher ground clearance, higher center of gravity, and narrower track than many passenger cars. It is capable of performing better in a wide variety of off-road applications. Driven in an unsafe manner, all vehicles can be caused to go out of control. Because of the higher center of gravity and the narrower track, if this vehicle is out of control it may roll over when some other vehicles may not.

Do not attempt sharp turns or abrupt maneuvers or other unsafe driving actions that can cause loss of vehicle control. Failure to operate this vehicle safely may result in an accident, roll over of the vehicle, and severe or fatal injury. Drive carefully.

Failure to use driver and passenger seat belts provided is a major cause of severe or fatal injury. In fact, the U.S. government notes that the universal use of existing seat belts could cut the highway death toll by 10,000 or more each year, and could reduce disabling injuries by 2 million annually. In a roll over crash an unbelted person is significantly more likely to die than a person wearing a seat belt. Always buckle up.

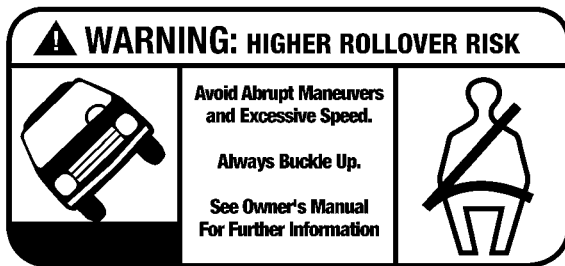

80bfe0f0

Roll Over Warning Label

This manual has been prepared with the assistance of service and engineering specialists to acquaint you with the operation and maintenance of your new vehicle. It is supplemented by a Warranty Information Booklet and various customer oriented documents. You are urged to read these publications carefully. Following the instructions and recommendations in this manual will help assure safe and enjoyable operation of your vehicle.

NOTE: After you read the manual, it should be stored in the vehicle for convenient reference and remain with the vehicle when sold so that the new owner will be aware of all safety warnings.

When it comes to service, remember that your authorized dealer knows your vehicle best, has the factory-trained technicians and genuine Mopar® parts, and is interested in your satisfaction.

WARNING!

Engine exhaust, some of its constituents, and certain vehicle components contain or emit chemicals known to the State of California to cause cancer and birth defects or other reproductive harm. In addition, certain fluids contained in vehicles and certain products of component wear contain or emit chemicals known to the State of California to cause cancer and birth defects or other reproductive harm.

HOW TO USE THIS MANUAL

Consult the table of contents to determine which section contains the information you desire.

The detailed index, at the rear of the manual, contains a complete listing of all subjects.

WARNINGS AND CAUTIONS

This manual contains **WARNINGS** against operating procedures which could result in an accident or bodily injury. It also contains **CAUTIONS** against procedures which could result in damage to your vehicle. If you do not read this entire manual you may miss important information. Observe all Warnings and Cautions.

VEHICLE IDENTIFICATION NUMBER

The vehicle identification number (VIN) is found on a label located on the left front corner of the instrument panel pad, visible from outside of the vehicle through the windshield. This number also appears on the Automobile Information Disclosure Label affixed to a window on your vehicle. Save this label for a convenient record of your vehicle identification number and optional equipment.

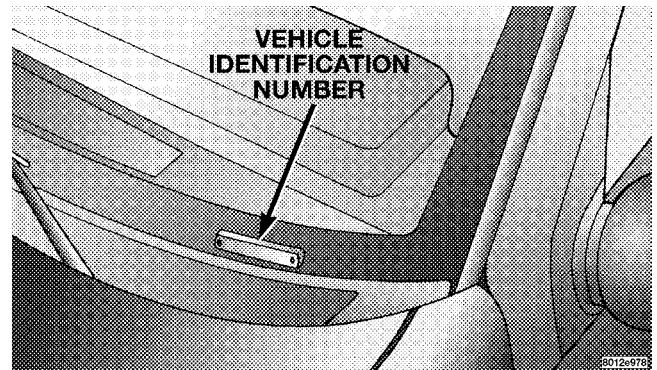

Vehicle Identification Number

NOTE: It is illegal to remove the VIN label.

VEHICLE MODIFICATIONS / ALTERATIONS

WARNING!

Any modifications or alterations to this vehicle could seriously affect its roadworthiness and safety and may lead to an accident resulting in serious injury or death.

THINGS TO KNOW BEFORE STARTING YOUR VEHICLE

CONTENTS

■ A Word About Your Keys11	■ Doors And Door Locks15
□ Ignition Key11	□ Manual Door Locks15
□ Key-In-Ignition Reminder12	□ Power Door Locks17
■ Sentry Key Immobilizer System12	■ Remote Keyless Entry18
□ Important Note About Service13	□ To Unlock The Doors18
□ Replacement Keys13	□ To Lock The Doors19
□ Customer Key Programming14	□ To Release The Liftgate Flipper Glass19
□ General Information14	□ Using The Panic Alarm19
■ Illuminated Entry15	□ General Information20

10 THINGS TO KNOW BEFORE STARTING YOUR VEHICLE

□ Transmitter Battery Service21	□ Energy Management Feature33
■ Security Alarm System — If Equipped22	□ Seat Belt Pretensioners34
□ To Set The Alarm22	□ Enhanced Driver Seat Belt Use Reminder System (BeltAlert)34
□ To Disarm The System22	□ Seat Belts And Pregnant Women35
■ Liftgate23	□ Seat Belt Extender36
□ Liftgate Flipper Glass24	□ Driver And Front Passenger Supplemental Restraint Systems (SRS)37
■ Power Windows25	□ Child Restraint53
□ Auto Down26	■ Engine Break-In Recommendations63
□ Window Lockout Switch26	■ Safety Tips64
□ Wind Buffeting26	□ Exhaust Gas64
■ Occupant Restraints27	□ Safety Checks You Should Make Inside The Vehicle65
□ Lap/Shoulder Belts28	□ Safety Checks You Should Make Outside The Vehicle65
□ Lap/Shoulder Belt Operating Instructions29		
□ Adjustable Upper Shoulder Belt Anchorage32		
□ Automatic Locking Mode — If Equipped33		

A WORD ABOUT YOUR KEYS

The keys for your new vehicle are enclosed in a plastic bag with the key code number on it. If you received your keys without the bag, ask your authorized dealer to give you the number. The key code can also be obtained by your authorized dealer from your vehicle invoice.

Ignition Key

Insert the key fully, then turn the switch to one of the four illustrated positions. The key can be inserted or withdrawn only in the OFF position. The gearshift lever must be in the P (Park) position.

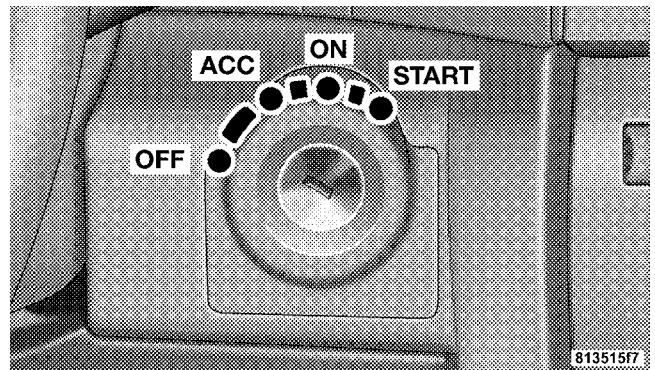

Ignition Key Positions

To remove the ignition key, place the gearshift lever in P (Park), turn the ignition key to OFF and remove the key.

Key-In-Ignition Reminder

If the driver's door is opened when the key is in the ignition and not turned to the ON position, a chime will sound to remind you to remove the key.

CAUTION!

Always remove the key from the ignition, and lock all doors when leaving the vehicle unattended.

SENTRY KEY IMMOBILIZER SYSTEM

The Sentry Key Immobilizer System (SKIS) prevents unauthorized operation of the vehicle by disabling the engine. The system will shut the engine down after 2 seconds of running if an invalid key is used to start the vehicle. This system utilizes ignition keys which have an electronic chip (transponder) embedded into them. Only

keys that have been programmed to the vehicle can be used to start and operate the vehicle for longer than the 2 second validation time period.

The Sentry Key Immobilizer System does not need to be armed or activated. Operation of the system is automatic regardless of whether or not the vehicle is locked or unlocked. During normal operation, the SKIS indicator light will come on for 3 seconds immediately after the ignition switch is turned on for a bulb check. Afterwards, if the bulb remains on, this indicates a malfunction in the electronics. If the bulb begins to flash immediately after the ignition switch is turned on, this indicates that an invalid key is being used to start the vehicle. Both of these conditions will result in the engine being shut down after 2 seconds of running. Keep in mind that a key which has not been programmed is also considered an invalid key even if it is cut to fit the ignition for that vehicle.

If the SKIS indicator light comes on during normal vehicle operation (it has been running for longer than 10 seconds) a fault has been detected in the electronics and the vehicle should be serviced as soon as possible.

NOTE:

- The Sentry Key Immobilizer System is not compatible with remote starting systems. Use of these systems may result in vehicle starting problems and loss of security protection.
- Mobil Speedpass™, additional Sentry Keys, or any other transponder equipped components on the same keychain will not cause a key-related (Transponder) fault unless the additional part is **physically held against the ignition key** being used when starting the vehicle. Also, cell phones, pagers, or other RF electronics will not cause interference with this system.

All of the keys provided with your new vehicle have been programmed to the vehicle electronics.

Important Note About Service

A four digit PIN number is needed to service the Sentry Key Immobilizer System. This number can be obtained from your authorized dealer. However, this number can also be found on your customer invoice that you were given upon receipt of your vehicle.

Replacement Keys

NOTE: Only keys that have been programmed to the vehicle electronics can be used to start the vehicle. Once a Sentry Key has been programmed to a vehicle, it cannot be programmed to any other vehicle.

At the time of purchase, the original owner is provided with a four digit PIN number. This number is required for dealer replacement of keys. Duplication of keys may be performed at an authorized dealer or by using the Customer Key Programming procedure. This procedure

14 THINGS TO KNOW BEFORE STARTING YOUR VEHICLE

consists of programming a blank key to the vehicle electronics. A blank key is one which has never been programmed.

NOTE: When having the Sentry Key System serviced, bring all vehicle keys to the dealer.

Customer Key Programming

You can program new keys to the system if you have two valid keys by doing the following:

1. Cut the additional Sentry Key Transponder blank(s) to match the ignition switch lock cylinder key code.
2. Insert the first valid key into the ignition switch and turn the ignition switch ON for at least 3 seconds but no longer than 15 seconds. Turn the ignition switch OFF and remove the first key.
3. Insert the second valid key and turn the ignition switch ON within 15 seconds. After ten seconds, a chime

will sound and the SKIS indicator light will begin to flash. Turn the ignition switch OFF and remove the second key.

4. Insert a blank Sentry Key into the ignition switch and turn the ignition switch ON within 60 seconds. After 10 seconds, a single chime will sound. The SKIS indicator light will stop flashing, turn on for 3 seconds; then turn off.

The new Sentry Key has been programmed. Repeat this process to program up to a total of 8 keys.

General Information

The Sentry Key Immobilizer System complies with FCC rules part 15 and with RSS-210 of Industry Canada. Operation is subject to the following two conditions:

1. This device may not cause harmful interference.
2. This device must accept any interference that may be received, including interference that may cause undesired operation.

ILLUMINATED ENTRY

The interior lights come on when you open any door. They will remain on for about 30 seconds after all doors are closed then fade to off.

The lights also will fade to off if you turn on the ignition after you close all the doors.

DOORS AND DOOR LOCKS

Manual Door Locks

Use the manual door lock plunger to lock the doors from inside the vehicle. If the plunger is down when the door is closed, the door will lock. Therefore, make sure the keys are not inside the vehicle before closing the door.

WARNING!

For personal security, and safety in the event of an accident, lock the vehicle doors as you drive as well as when you park and leave the vehicle.

2

WARNING!

When leaving the vehicle always remove the key from the ignition lock, and lock your vehicle. Do not leave children unattended in the vehicle, or with access to an unlocked vehicle. Unsupervised use of vehicle equipment may cause severe personal injuries and death.

CAUTION!

An unlocked vehicle is an invitation to thieves. Always remove the key from the ignition and lock all of the doors when leaving the vehicle unattended.

Child Protection Locks

The rear doors of your vehicle are equipped with child protection locks. If you push up on the lever on the open edge of the door it cannot be opened from the inside of the vehicle. Push the lever down to disengage the child protection locks.

WARNING!

Avoid trapping anyone in the vehicle in a collision. Remember that the rear doors can only be opened from the outside when the child protection locks are engaged.

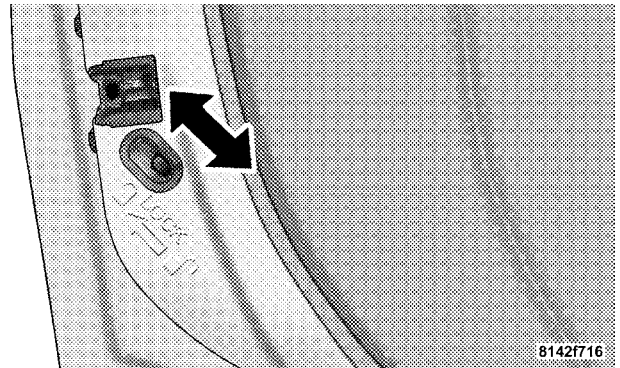

Child Lock Control

Power Door Locks

A door lock switch is on each front door panel. Press this switch to lock or unlock the doors.

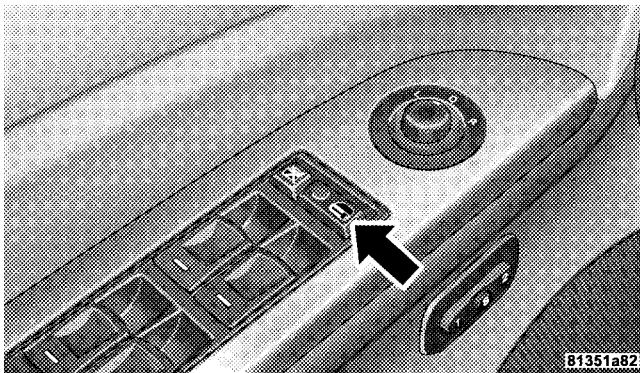

Power Door Lock Switch

If the plunger is down when the door is closed, the door will lock. Therefore, make sure the keys are not inside the vehicle before closing the door.

If you press the door lock switch while the keys are in the ignition switch, and the driver's door is open, the doors will not lock.

The rear doors cannot be opened from inside the vehicle until you pull up the lock plungers.

Automatic Door Locks

If this feature is selected your door locks will lock automatically if the vehicle speed is above 15 mph (24 km/h) and all doors are closed. It will reset whenever a door is opened.

This feature is selectable and can be turned on or off. Refer to "Electronic Vehicle Information Center (EVIC) — Customer Programmable Features" in Section 4 of this manual or see your authorized dealer.

Automatic Unlock on Exit Feature — Only Available if Auto Lock is Enabled

This feature will unlock all the doors when the driver's door is opened if the vehicle is stopped and in P (Park) or N (Neutral). Refer to "Electronic Vehicle Information Center (EVIC) — Customer Programmable Features" in Section 4 of this manual or see your authorized dealer.

REMOTE KEYLESS ENTRY

This system allows you to lock or unlock the doors, liftgate, or activate the panic alarm from distances up to about 23 feet (7 meters) using a hand held radio transmitter. The transmitter need not be pointed at the vehicle to activate the system.

NOTE: If the key is in the ignition switch, then all buttons on that transmitter will be disabled. The buttons on the remaining transmitters will work. If the vehicle is shifted out of P (Park), all the transmitter buttons are disabled for all keys.

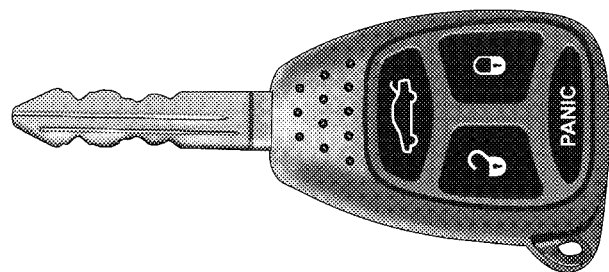

8125e0aa

Four Button Transmitter

To Unlock the Doors

Press and release the "Unlock" button on the transmitter once to unlock the driver's door, or twice to unlock all doors. The turn signal lights will flash twice to acknowledge the unlock signal. The illuminated entry system also turns on.

NOTE: If desired, the system can be programmed to unlock all doors on the first press of the “Unlock” button. Refer to “Remote Unlock Driver’s Door 1st” in the Personal Settings section of the “Electronic Vehicle Information Center (EVIC)”, or simply follow these steps:

1. Press the “Unlock” button for 4 to 10 seconds.
2. While the “Unlock” button is pressed, (after 4 seconds) press the “Lock” button. Release both buttons.

The “Remote Unlock Driver’s Door 1st” feature can be reactivated by repeating this procedure.

To Lock the Doors

Press and release the “Lock” button on the transmitter to lock all doors. The turn signal lights will flash once to acknowledge the lock signal. The horn will chirp once to acknowledge the signal. If desired, the “Sound Horn On Lock” feature can be turned on and off by referring to the

Customer Programmable Features of the “Electronic Vehicle Information Center (EVIC)” section or by following these steps.

1. Press the “Lock” button for 4 to 10 seconds.
2. While the “Lock” button is pressed (after 4 seconds), press the PANIC button. Release both buttons.

The “Sound Horn On Lock” feature can be reactivated by repeating this procedure.

To Release the Liftgate Flipper Glass

Press the “Flipper Glass/Trunk Release” button on the transmitter two times to release the flipper glass.

Using The Panic Alarm

To turn the panic alarm feature ON or OFF, press and hold the PANIC button on the transmitter for at least one second and release. When the panic alarm is on, the headlights and park lights will flash, the horn will pulse on and off and the interior lights will turn on.

20 THINGS TO KNOW BEFORE STARTING YOUR VEHICLE

The panic alarm will stay on for 3 minutes unless you turn it off by pressing the PANIC button a second time or if the vehicle speed is 15 mph (24 km/h) or greater.

NOTE: The interior lights will turn off when the ignition is switched to the ACC or ON position after the panic alarm is activated. However, the exterior lights and horn will remain on.

NOTE: When you turn off the panic alarm by pressing the PANIC button a second time, you may have to be closer to the vehicle due to the radio frequency noises of the system.

To Turn Off “Flash Lights On Lock/Unlock”

NOTE: If desired, the “Flash Lights On Lock/Unlock” feature can be turned on and off by referring to the Customer Programmable Features of the “Electronic Vehicle Information Center (EVIC)” section or by following these steps.

1. Press the LOCK button for 4 to 10 seconds.
2. While the LOCK button is pressed, (after 4 seconds) press the UNLOCK button. Release both buttons.

The “Flash Lights On Lock/Unlock” feature can be reactivated by repeating this procedure.

General Information

This device complies with part 15 of the FCC rules and RSS 210 of Industry Canada. Operation is subject to the following conditions:

- This device may not cause harmful interference.
- This device must accept any interference received, including interference that may cause undesired operation.

If your Remote Keyless Entry transmitter fails to operate from a normal distance, check for these two conditions.

1. A weak battery in the transmitter. The expected life of the battery is a minimum of three years.
2. Closeness to a radio transmitter such as a radio station tower, airport transmitter, and some mobile or CB radios.

Transmitter Battery Service

The recommended replacement battery is one CR2032 battery.

NOTE: Do not touch the battery terminals that are on the back housing or the printed circuit board.

1. With the transmitter buttons facing down, use a small screwdriver or similar flat object to pry the two halves of the transmitter apart. Make sure not to damage the rubber gasket during removal.

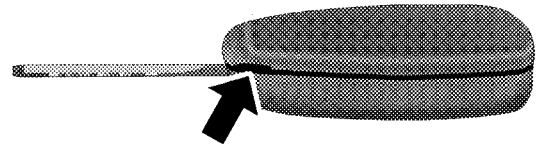

2

81182c72

Separating Transmitter Halves

2. Remove and replace the battery. Avoid touching the new battery with your fingers. Skin oils may cause battery deterioration. If you touch a battery, clean it with rubbing alcohol.

3. To reassemble the transmitter case, snap the two halves together. Make sure there is an even “gap” between the two halves. Test transmitter operation.

SECURITY ALARM SYSTEM — IF EQUIPPED

This system monitors the vehicle doors, liftgate, liftgate flipper glass, and ignition for unauthorized operation. When the alarm is activated, the system provides both audible and visual signals. The horn will sound repeatedly for three minutes and the headlights and taillights will flash for an additional 15 minutes.

To Set the Alarm

The alarm will set when you use the remote keyless entry transmitter to lock the doors and liftgate or when you use the power door lock switch while the door is open. After all the doors are locked and closed, a red light (located in the instrument cluster) will flash rapidly for about 16 seconds to signal that the system is arming. During this 16 second pre-arm period, opening any door or the

liftgate will cancel the arming. If the system successfully arms, the red light will flash at a slower rate to indicate the alarm is set. A manual lock of the doors, either with the door lock plunger located on the inside of the doors or with the driver’s door key lock cylinder, will not set the alarm.

To Disarm the System

To disarm the system, use the remote keyless entry transmitter or the key to unlock the driver’s door. If something has triggered the system in your absence, the horn will sound three times when you unlock the doors. Check the vehicle for tampering.

The Security Alarm System is designed to protect your vehicle; however, you can create conditions where the system will arm unexpectedly. If you remain in the vehicle and lock the doors with the transmitter, once the system is armed (after 16 seconds), when you pull the door handle to exit the alarm will sound. If this occurs,

press the "Unlock" button on the remote keyless entry transmitter to disarm the system. The Security Alarm System will not disarm with a manual unlock, either through the lock plunger located on the inside of the door, or through a key in the driver's door key cylinder.

LIFTGATE

To open the liftgate, pull up (squeeze) on the handle and lift. Manually unlocking the vehicle doors with the plunger or a key in the lock cylinder will not unlock the liftgate.

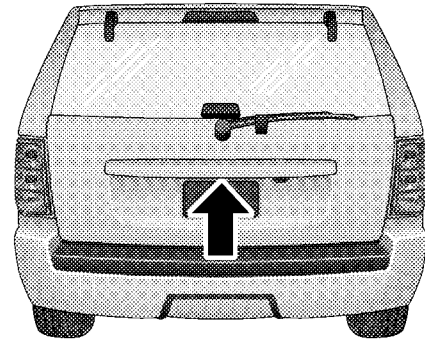

Liftgate Release

81351aac

WARNING!

Driving with the liftgate open can allow poisonous exhaust gases into your vehicle. You and your passengers could be injured by these fumes. Keep the liftgate closed when you are operating the vehicle.

Liftgate Flipper Glass

The liftgate flipper glass is also unlocked when the liftgate is unlocked. To open the flipper glass, push up on the window switch located on the liftgate.

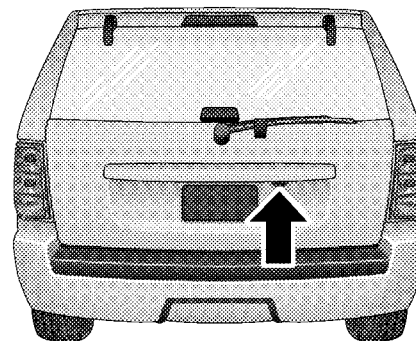

8144ded8

Liftgate Glass Release

WARNING!

To avoid injury stand back when opening. Glass will automatically rise.

Once the liftgate flipper glass has been opened, connection to the rear window wiper is interrupted, preventing activation of the rear wiper blade while the flipper glass is open.

NOTE: If a power malfunction to the power liftgate latch should occur, an emergency liftgate latch release can be used to open the liftgate. The emergency liftgate latch release can be accessed through a snap-in cover located on the liftgate trim panel.

WARNING!

Driving with the flipper glass open can allow poisonous exhaust gases into your vehicle. You and your passengers could be injured by these fumes. Keep the flipper glass closed when you are operating the vehicle.

POWER WINDOWS

The power window controls are located on the driver's door trim panel. There is a single switch on the front passenger door/rear doors which operates the front passenger/rear passenger door windows.

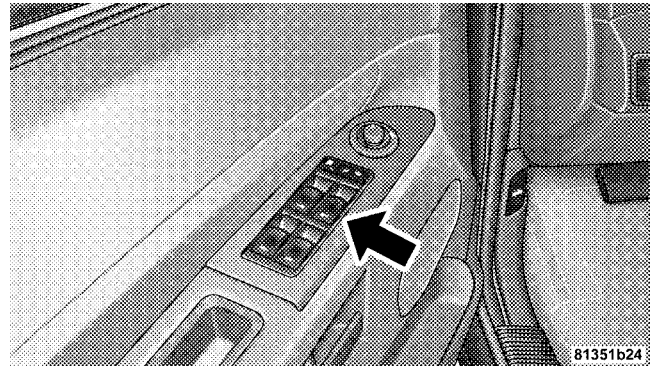

Power Window Switches

The power window switches remain active for up to 10 minutes after the ignition switch has been turned off. Opening a vehicle front door will cancel this feature.

Auto Down

The driver's window switch has an "Auto Down" feature. Press the window switch past the first detent, release, and the window will go down automatically. To cancel the "Auto Down" movement, operate the switch in either the up or down direction and release the switch.

Window Lockout Switch

The window lockout switch on the driver's door allows you to disable the window control on the other doors. To disable the window controls on the other doors, press the window lockout button. To enable the window controls, press the window lockout button again.

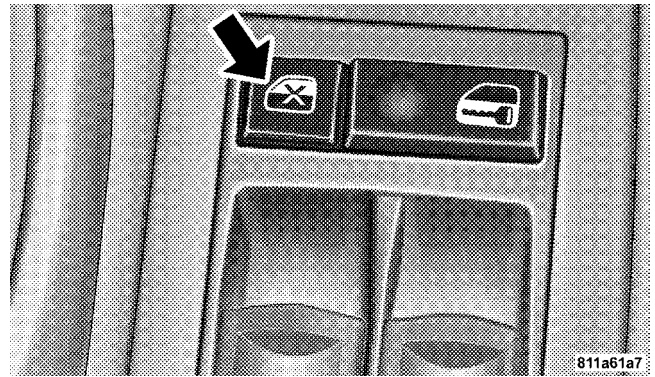

Power Window Lock

Wind Buffeting

Wind buffeting can be described as the perception of pressure on the ears or a helicopter type sound in the ears. Your vehicle may exhibit wind buffeting with the windows down, or the sunroof (if equipped) in certain

open or partially open positions. This is a normal occurrence and can be minimized. If the buffeting occurs with the sunroof open, adjust the sunroof opening to minimize the buffeting.

OCCUPANT RESTRAINTS

Some of the most important safety features in your vehicle are the restraint systems. These include the front and rear seat belts for the driver and all passengers, front airbags for both the driver and right front passenger, and, if equipped, window bags for the driver and passengers seated next to a window. If you will be carrying children too small for adult-size belts, your seat belts also can be used to hold infant and child restraint systems.

NOTE: The front airbags have a multi stage inflator design. This allows the airbag to have different rates of inflation that are based on collision severity.

Please pay close attention to the information in this section. It tells you how to use your restraint system properly to keep you and your passengers as safe as possible.

WARNING!

In a collision, you and your passengers can suffer injuries, including fatalities, if you are not properly buckled up. You can strike the interior of your vehicle or other passengers, or you can be thrown out of the vehicle. Always be sure you and others in your vehicle are buckled up properly.

Buckle up even though you are an excellent driver, even on short trips. Someone on the road may be a poor driver and cause a collision which includes you. This can happen far away from home or on your own street.

Research has shown that seat belts save lives, and they can reduce the seriousness of injuries in a collision. Some of the worst injuries happen when people are thrown from the vehicle. Seat belts reduce the possibility of ejection and the risk of injury caused by striking the inside of the vehicle. **Everyone** in a motor vehicle should be belted at all times to reduce or prevent injuries.

Lap/Shoulder Belts

All seating positions in your vehicle have combination lap/shoulder belts. The belt webbing retractor is designed to lock during very sudden stops or collisions. This feature allows the shoulder part of the belt to move freely with you under normal conditions. But in a collision, the belt will lock and reduce the risk of you striking the inside of the vehicle or being thrown out.

WARNING!

- **Wearing a seat belt incorrectly is dangerous. Seat belts are designed to go around the large bones of your body. These are the strongest parts of your body and can take the forces of a collision the best. Wearing your belt in the wrong place could make your injuries in a collision much worse. You might suffer internal injuries, or you could even slide out of part of the belt. Follow these instructions to wear your seat belt safely and to keep your passengers safe, too.**
- **Two people should never be belted into a single seat belt. People belted together can crash into one another in an accident, hurting one another badly. Never use a lap/shoulder belt or a lap belt for more than one person, no matter what their size.**

Lap/Shoulder Belt Operating Instructions

1. Enter the vehicle and close the door. Sit back and adjust the seat.
2. The seat belt latch plate is above the back of your seat. Grasp the latch plate and pull out the belt. Slide the latch plate up the webbing as far as necessary to make the belt go around your lap.

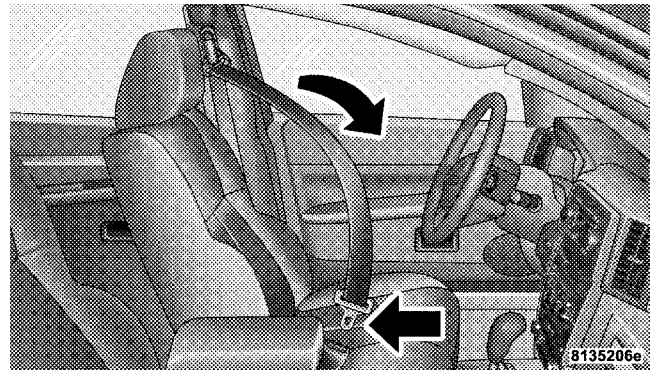
**Latch Plate**

30 THINGS TO KNOW BEFORE STARTING YOUR VEHICLE

3. When the belt is long enough to fit, insert the latch plate into the buckle until you hear a "click."

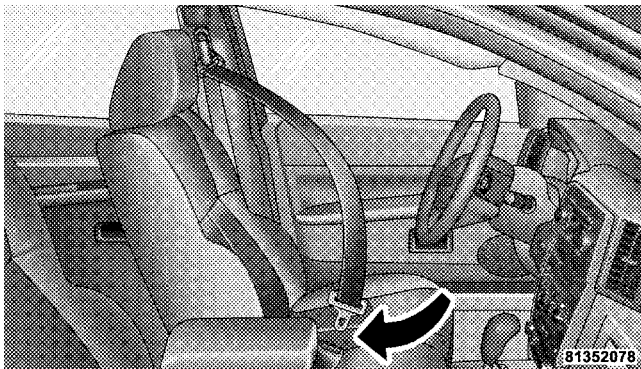

Latch Plate To Buckle

WARNING!

A belt that is buckled into the wrong buckle will not protect you properly. The lap portion could ride too high on your body, possibly causing internal injuries. Always buckle your belt into the buckle nearest you.

A belt that is too loose will not protect you as well. In a sudden stop you could move too far forward, increasing the possibility of injury. Wear your seat belt snugly.

A belt that is worn under your arm is very dangerous. Your body could strike the inside surfaces of the vehicle in a collision, increasing head and neck injury. A belt worn under the arm can cause internal injuries. Ribs aren't as strong as shoulder bones. Wear the belt over your shoulder so that your strongest bones will take the force in a collision.

A shoulder belt placed behind will not protect you from injury during a collision. You are more likely to hit your head in a collision if you do not wear your shoulder belt. The lap and shoulder belt are meant to be used together.

4. Position the lap belt across your thighs, below your abdomen. To remove slack in the lap portion, pull up a bit on the shoulder belt. To loosen the lap belt if it is too tight, tilt the latch plate and pull on the lap belt. A snug belt reduces the risk of sliding under the belt in a collision.

5. Position the shoulder belt on your chest so that it is comfortable and not resting on your neck. The retractor will withdraw any slack in the belt.

WARNING!
<p>A lap belt worn too high can increase the risk of injury in a collision. The belt forces won't be at the strong hip and pelvic bones, but across your abdomen. Always wear the lap part of your seat belt as low as possible and keep it snug.</p> <p>A twisted belt can't do its job as well. In a collision it could even cut into you. Be sure the belt is straight. If you can't straighten a belt in your vehicle, take it to your authorized dealer and have it fixed.</p>

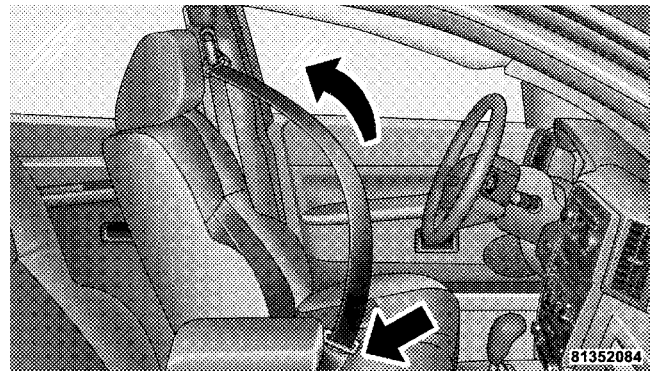

Removing Slack From Belt

6. To release the belt, push the red button marked PRESS on the buckle. The belt will automatically retract to its stowed position. If necessary, slide the latch plate down the webbing to allow it to retract fully.

WARNING!

A frayed or torn belt could rip apart in a collision and leave you with no protection. Inspect the belt system periodically, checking for cuts, frays, or loose parts. Damaged parts must be replaced immediately. Do not disassemble or modify the system. Seat belt assemblies must be replaced after an accident if they have been damaged (bent retractor, torn webbing, etc.).

Adjustable Upper Shoulder Belt Anchorage

In the front seating positions, the shoulder belt can be adjusted upward or downward to position the belt away from your neck. Press the release button to release the anchorage, and then move it up or down to the position that serves you best.

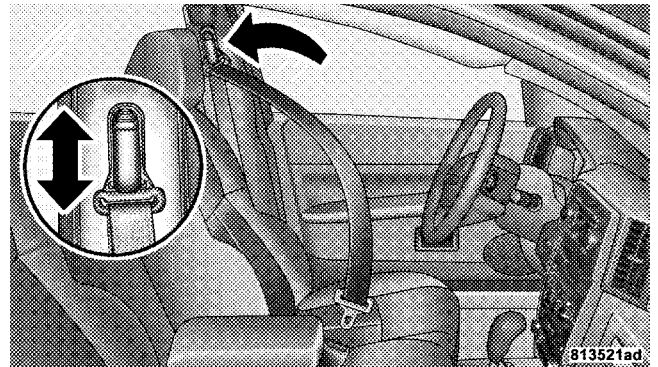

Adjusting Upper Shoulder Belt

As a guide, if you are shorter than average, you will prefer a lower position, and if you are taller than average, you'll prefer a higher position. When you release the anchorage, try to move it up or down to make sure that it is locked in position.

Automatic Locking Mode — If Equipped

In this mode, the shoulder belt is automatically pre-locked. The belt will still retract to remove any slack in the shoulder belt.

When To Use The Automatic Locking Mode

Anytime a child safety seat is installed in the rear center seating position. Children 12 years old and under should be properly restrained in the rear seat whenever possible.

How To Use The Automatic Locking Mode

1. Buckle the combination lap and shoulder belt.
2. Grasp the shoulder portion and pull downward until the entire belt is extracted.

3. Allow the belt to retract. As the belt retracts, you will hear a clicking sound. This indicates the safety belt is now in the automatic locking mode.

How to Disengage The Automatic Locking Mode

Disconnect the combination lap/shoulder belt and allow it to retract completely to disengage the automatic locking mode and activate the vehicle sensitive (emergency) locking mode.

Energy Management Feature

This vehicle has a safety belt system with an energy management feature in the front seating positions to help further reduce the risk of injury in the event of a head-on collision.

This safety belt system has a retractor assembly that is designed to release webbing in a controlled manner. This feature is designed to help reduce the belt force acting on the occupant's chest.

WARNING!

- The belt and retractor assembly must be replaced if the seat belt assembly “automatic locking retractor” feature or any other seat belt function is not working properly when checked according to the procedures in the Service Manual.
- Failure to replace the belt and retractor assembly could increase the risk of injury in collisions.

Seat Belt Pretensioners

The driver and front passenger seat belts are equipped with a pretensioning device that is designed to remove any slack from the seat belt systems in the event of a collision. This device improves the performance of the seat belt by assuring that the belt is tight around the occupant early in a collision. Pretensioners work for all size occupants, including those in child restraints.

NOTE: These devices are not a substitute for proper seat belt placement by the occupant. The seat belt must still be worn snugly and positioned properly.

The pretensioners are triggered by the Occupant Restraint Control (ORC) Module. Like the front airbags, the pretensioners are a single use item. After a collision that is severe enough to deploy the airbags and pretensioners, they must be replaced.

Enhanced Driver Seat Belt Use Reminder System (BeltAlert)

If the driver’s seat belt has not been buckled within 60 seconds of starting the vehicle and if the vehicle speed is greater than 5 mph (8 km/h), the Enhanced Warning System (BeltAlert) will alert the driver to buckle their seat belt. The driver should also instruct all other occupants to buckle their seat belts. Once the warning is triggered, the Enhanced Warning System (BeltAlert) will continue to chime and flash the Seat Belt Warning Light for 96

seconds or until the driver's seat belt is buckled. The Enhanced Warning System (BeltAlert) will be reactivated if the driver's seat belt is unbuckled for more than 10 seconds and the vehicle speed is greater than 5 mph (8 km/h).

The Enhanced Warning System (BeltAlert) can be enabled or disabled by your authorized dealer or by following these steps:

NOTE: The following steps must occur within the first 60 seconds of the ignition switch being turned to the ON or START position. The manufacturer does not recommend deactivating the Enhanced Warning System (BeltAlert).

1. Turn the ignition switch to the OFF position, and fasten the driver's seat belt.
2. Start the engine, and wait for the Seat Belt Warning Light to turn off.

3. Within 60 seconds of starting the vehicle, unbuckle and then re-buckle the driver's seat belt at least three times, ending with the seat belt buckled.

4. Turn off the engine. A single chime will sound to signify that you have successfully completed the programming.

The Enhanced Warning System (BeltAlert) can be reactivated by repeating this procedure.

NOTE: Although the Enhanced Warning System (BeltAlert) has been deactivated, the Seat Belt Warning Light will continue to illuminate while the driver's seat belt remains unfastened.

Seat Belts and Pregnant Women

We recommend that pregnant women use the seat belts throughout their pregnancy. Keeping the mother safe is the best way to keep the baby safe.

Pregnant women should wear the lap part of the belt across the thighs and as snug across the hips as possible. Keep the belt low so that it does not come across the abdomen. That way the strong bones of the hips will take the force if there is a collision.

Seat Belt Extender

If a seat belt is too short, even when fully extended and when the adjustable upper shoulder belt anchorage (if equipped) is in its lowest position, your authorized dealer can provide you with a seat belt extender. This extender should be used only if the existing belt is not long enough. When it is not required, remove the extender and store it.

WARNING!

Using a seat belt extender when not needed can increase the risk of injury in a collision. Only use when the lap belt is not long enough when it is worn low and snug, and in the recommended seating positions. Remove and store the extender when not needed.

Driver And Front Passenger Supplemental Restraint Systems (SRS)

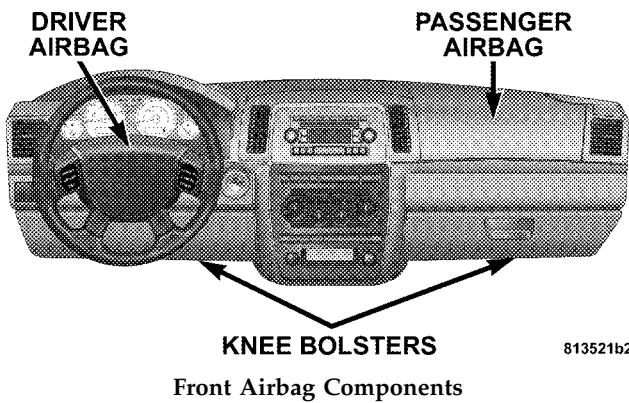

This vehicle has airbags for both the driver and right front passenger as a supplement to the seat belt restraint systems. The driver's front airbag is mounted in the steering wheel. The passenger side airbag is mounted in the instrument panel, above the glove compartment. The words SRS/AIRBAG are embossed on the airbag covers.

2

NOTE: The front airbags are certified to the Federal regulations that allow less forceful deployment.

The front airbags have a multistage inflator design. This may allow the airbag to have different rates of inflation that are based on collision severity and occupant size. Also, the front passenger airbag is certified to the Federal regulations that define Occupant Classification (Refer to "Occupant Classification System" in this section).

38 THINGS TO KNOW BEFORE STARTING YOUR VEHICLE

This vehicle may also be equipped with window bags to protect the driver, front, and rear passengers sitting next to a window. If the vehicle is equipped with window bags, they are located above the side windows. Their covers are also labeled SRS/AIRBAG.

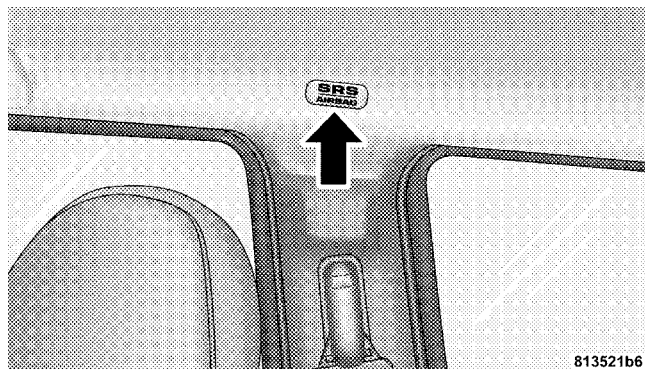

Window Airbag Location

NOTE: Airbag covers may not be obvious in the interior trim; but they will open to allow airbag deployment.

WARNING!

- Do not put anything on or around the front airbag covers or attempt to manually open them. You may damage the airbags and you could be injured because the airbags are not there to protect you. These protective covers for the airbag cushions are designed to open only when the airbags are inflating.
- If your vehicle is equipped with window bags, do not stack luggage or other cargo up high enough to block the location of the window bag. The area where the window bag is located should remain free from any obstructions.
- If your vehicle is equipped with window bags, do not have any accessory items installed which will alter the roof, including adding a sunroof to your vehicle. Do not add roof racks that require permanent attachments (bolts or screws) for installation on the vehicle roof. Do not drill into the roof of the vehicle for any reason.
- Do not cover or place items on the airbag covers. These items may cause serious injury during inflation.

The front airbags have a multi stage inflator design. This allows the airbag to have different rates of inflation that are based on collision severity. Along with the seat belts, front airbags work with the instrument panel knee bolsters to provide improved protection for the driver and front passenger. Window bags also work with seat belts to improve occupant protection.

The seat belts are designed to protect you in many types of collisions. The front airbags deploy in moderate to severe frontal collisions.

NOTE: The passenger front airbag may not deploy even when the driver front airbag has if the Occupant Classification System (refer to "Occupant Classification System" in this section) has determined the passenger seat is empty or is occupied by someone that is classified in the "small child" category.

If your vehicle is so equipped, the window bag on the crash side of the vehicle is triggered in moderate to

severe side collisions. In certain types of collisions, both the front and side airbags may be triggered. But even in collisions where the airbags work, you need the seat belts to keep you in the right position for the airbags to protect you properly.

Here are some simple steps you can take to minimize the risk of harm from a deploying airbag.

1. Children 12 years and under should always ride buckled up in a rear seat.

Infants in rear facing child restraints should **NEVER** ride in the front seat of a vehicle with a passenger airbag. An airbag deployment could cause severe injury or death to infants in that position.

Children that are not big enough to properly wear the vehicle seat belt should be secured in the rear seat, in a child restraint or belt-positioning booster seat. Older

40 THINGS TO KNOW BEFORE STARTING YOUR VEHICLE

children who do not use child restraints or belt-positioning booster seats should ride properly buckled up in the rear seat. Never allow children to slide the shoulder belt behind them or under their arm.

If a child from 1 to 12 years old must ride in the front passenger seat because the vehicle is crowded, move the seat as far back as possible, and use the proper child restraint. See “Child Restraint” in this section.

You should read the instructions provided with your child restraint to make sure that you are using it properly.

2. All occupants should use their lap and shoulder belts properly.

3. The driver and front passenger seats should be moved back as far as practical to allow the front airbags room to inflate.

4. If your vehicle has window bags, do not lean against the door or window, airbags will inflate forcefully into the space between you and the door.

5. If the airbag system in this vehicle needs to be modified to accommodate a disabled person, contact the Customer Center. Phone numbers are provided under “If You Need Assistance” in Section 9 of this manual.

WARNING!

- Relying on the airbags alone could lead to more severe injuries in a collision. The airbags work with your seat belt to restrain you properly. In some collisions the airbags won't deploy at all. Always wear your seat belts even though you have airbags.
- Being too close to the steering wheel or instrument panel during airbag deployment could cause serious injury. Airbags need room to inflate. Sit back, comfortably extending your arms to reach the steering wheel or instrument panel.
- If the vehicle has left and right side curtain airbags, they also need room to inflate. Do not lean against the door or window. Sit upright in the center of the seat.

Airbag System Components

The airbag system consists of the following:

- Occupant Restraint Control Module
- Airbag Warning Light
- Driver Airbag
- Passenger Airbag
- Side Curtain Airbags above Side Windows (If Equipped)
- Side Remote Acceleration Sensors (If Equipped)
- Steering Wheel and Column
- Instrument Panel
- Interconnecting Wiring
- Knee Impact Bolsters

- Front Acceleration Sensors
- Driver and Front Passenger Seat Belt Pretensioner
- Occupant Classification System (OCS) — Front Passenger Seat Only
 - Occupant Classification Module
 - Passenger Airbag Disable (PAD) Indicator Light
 - Weight Sensors

How The Airbag System Works

- The **Occupant Restraint Control (ORC) Module** determines if a frontal collision is severe enough to require the airbags to inflate. The front airbag inflators are designed to provide different rates of airbag inflation from direction provided by the ORC. The ORC may also modify the rate of inflation based on the

occupant size provided by the Occupant Classification Module. The ORC will not detect roll over, or rear impacts.

The ORC also monitors the readiness of the electronic parts of the system whenever the ignition switch is in the START or ON positions. These include all of the items listed above except the knee bolster, the instrument panel, and the steering wheel and column. If the key is in the LOCK position, in the ACC position, or not in the ignition, the airbags are not on and will not inflate.



Also, the ORC turns on the “Airbag Warning Light” and “PAD Indicator Light” for 6 to 8 seconds for a self-check when the ignition is first turned on. After the self-check, the “Airbag Warning Light” will turn off. The “PAD Indicator Light” will function normally (Refer to “Passenger Airbag Disable (PAD) Indicator Light” in this

section). If the ORC detects a malfunction in any part of the system, it turns on the “Airbag Warning Light” either momentarily or continuously. A single chime will sound if the light comes on again after initial start up.

WARNING!

Ignoring the “Airbag Warning Light” in your instrument panel could mean you won’t have the airbags to protect you in a collision. If the light does not come on, stays on after you start the vehicle, or if it comes on as you drive, have the airbag system checked right away.

- The **Occupant Classification System (OCS)** is part of a Federally regulated safety system required for this vehicle. It is designed to turn off the front passenger airbag in the unlikely event that a rear-facing infant seat is in the front passenger seat.

NOTE: Children 12 years and under should always ride buckled up in a rear seat in an appropriate child restraint.

- The **Passenger Airbag Disable (PAD) Indicator Light** (an amber light located in the center of the instrument panel) tells the driver and front passenger when the front passenger airbag is turned off. The “PAD Indicator Light” illuminates the words “PASS AIR BAG OFF” to show that the passenger airbag will not inflate during a collision requiring airbags. When the right front passenger seat is empty or when very light

44 THINGS TO KNOW BEFORE STARTING YOUR VEHICLE

objects are placed on the seat, the passenger airbag will not inflate even though the “PAD Indicator Light” is not illuminated.



Indicator Light Location

The “PAD Indicator Light” should not be illuminated when teenagers, most children in a forward-facing child restraint or booster seats, most children that can

properly wear the vehicle’s seat belt, and when an adult passenger is properly seated in the front passenger seat. In this case, the airbag is ready to be inflated if a collision requiring an airbag occurs.

For almost all properly installed rear facing child restraints, the “PAD Indicator Light” will be illuminated indicating that the front passenger airbag is turned off and will not inflate. If the “PAD Indicator Light” is not illuminated, **DO NOT** assume the airbag is turned off and move the child restraint to the rear seat. A deploying passenger airbag can cause death or serious injury to a child in a rear facing infant seat.

NOTE: Even though this vehicle is equipped with an Occupant Classification System, children 12 years and under should always ride buckled up in a rear seat in an appropriate child restraint.

Front Passenger Seat Occupant	Passenger Airbag Disable (PAD) Indicator Light	Airbag Status
Adult	OFF	ON
Grocery Bags, Heavy Briefcases and Other Relatively Light Objects	ON	OFF
Empty or Very Small Objects	OFF*	OFF
* Since the system senses weight, some small objects will turn the PAD Indicator Light on.		

The OCS classifies an occupant using weight sensors mounted in the base of the front passenger seat. Any weight on the seat will be sensed by the system. Objects hanging on the seat or other passengers pushing down on the seat will also be sensed. The weight of an adult will cause the system to turn the airbag on. In this case, the OCS has classified the occupant of the seat as an

adult. An adult occupant needs to sit in a normal position (with their feet on or near the floor) in order to be properly classified. Reclining the seat back too far may change how an occupant is classified by the OCS.

2

Drivers and adult passengers should verify that the “PAD Indicator Light” is not illuminated when an adult is riding in the front passenger seat. If an adult occupant’s weight is transferred to another part of the vehicle (like the door or instrument panel), the weight sensors in the seat may not properly classify the occupant. Objects lodged under the seat or between the seat and the center console can prevent the occupant’s weight from being measured properly and may result in the occupant being improperly classified. Ensure that the front passenger seat back does not touch anything placed on the back seat because this can also affect occupant classification. Also, if you fold down the rear seat check to be sure it doesn’t touch the front passenger seat.

If the front passenger seat is damaged in any way, it should only be serviced by an authorized dealer. If the seat is removed (or even if the seat attachment bolts are loosened or tightened in any way), take the vehicle to an authorized dealer.

If there is a fault present in the OCS, the “Airbag Warning Light” (a red light located in the center of the instrument cluster directly in front of the driver) will be turned on. This indicates that you should take the vehicle to an authorized dealer. The “Airbag Warning Light” is turned on whenever there is a fault that can affect the operation of the airbag system. If there is a fault present in the OCS, both the “PAD Indicator Light” and the “Airbag Warning Light” are illuminated to show that the passenger airbag is turned off until the fault is cleared. If an object is lodged under the seat and interferes with operation of the weight sensors, a fault will occur which turns on both the “PAD Indicator Light” and the “Airbag Warning

Light.” Once the lodged object is removed, the fault will be automatically cleared after a short period of time.

- The **Driver and Passenger Airbag/Inflator Units** are located in the center of the steering wheel and the right side of the instrument panel. When the ORC detects a collision requiring the airbags, it signals the inflator units. A large quantity of nontoxic gas is generated to inflate the front airbags. Different airbag inflation rates are possible, based on collision severity and occupant size. The steering wheel hub trim cover and the upper right side of the instrument panel separate and fold out of the way as the bags inflate to their full size. The bags fully inflate in about 50–70 milliseconds. This is about half of the time it takes to blink your eyes. The bags then quickly deflate while helping to restrain the driver and front passenger.

The driver front airbag gas is vented through the vent holes in the sides of the airbag. The passenger front

airbag gas is vented through the vent holes in the sides of the airbag. In this way, the airbags do not interfere with your control of the vehicle.

- The **Occupant Classification Module (OCM)** is located beneath the front passenger seat. The OCM classifies the occupant into categories based on the measurements made by the seat weight sensors. The OCM communicates with the Occupant Restraint Control (ORC) Module. The ORC uses the occupant category to determine whether the front passenger airbag should be turned off. It also determines the rate of airbag inflation during a collision.
- Your vehicle has four **Weight Sensors** located between the seat and the floor pan. The weight sensors measure applied weight and transfers that information to the OCM.
- The **Side Impact SRS Side Curtain Airbags** are designed to activate only in certain side collisions. When

the ORC (with side impact option) detects a collision requiring the side curtain airbag to inflate, it signals the inflators on the crash side of the vehicle. A quantity of nontoxic gas is generated to inflate the side curtain airbag. The inflating side curtain airbag pushes the outside edge of the headliner out of the way and covers the window. The airbag inflates in about 30 milliseconds (about one quarter of the time it takes to blink your eyes) with enough force to injure you if you are not belted and seated properly, or if items are positioned in the area where the side curtain airbag inflates. This especially applies to children. The side curtain airbag is only about 3½ inches (9 cm) thick when it is inflated.

- The **Knee Impact Bolsters** help protect the knees of the driver and the front passenger, and position everyone for the best interaction with the front airbag.

48 THINGS TO KNOW BEFORE STARTING YOUR VEHICLE

The front passenger seat assembly contains critical components that affect the front passenger airbag deployment. Correctly functioning front passenger seat components are critical for the Occupant Classification System (OCS) to properly classify the front passenger and calculate the proper airbag deployment. Do not make any modifications to the front passenger seat components, assembly, or to the seat cover.

The following requirements must be strictly adhered to:

- Do not modify the front passenger seat assembly or components in any way.
- Do not modify the front seat center console or center position seat in any way.
- Do not use prior or future model year seat covers not designated for the specific model being repaired. Always use the correct seat cover specified for the vehicle.
- Do not replace the seat cover with an aftermarket seat cover.
- Do not add a secondary seat cover other than those approved by DaimlerChrysler/Mopar.
- At no time should any supplemental restraint system (SRS) component or SRS related component or fastener be modified or replaced with any part except those which are approved by DaimlerChrysler/Mopar.

WARNING!

Unapproved modifications or service procedures to the front passenger seat assembly, its related components, or seat cover may inadvertently change the airbag deployment in case of a frontal crash. This could result in death or serious injury to the front seat passenger if the vehicle is involved in an accident. A modified vehicle may not comply with required Federal Motor Vehicle Safety Standards (FMVSS).

If A Deployment Occurs

The airbag system is designed to deploy when the Occupant Restraint Control (ORC) Module detects a moderate-to-severe frontal collision, to help restrain the driver and front passenger, and then to immediately deflate.

NOTE: A frontal collision that is not severe enough to need airbag protection will not activate the system. This does not mean something is wrong with the airbag system.

If you do have a collision which deploys the airbags, any or all of the following may occur:

- The nylon airbag material may sometimes cause abrasions and/or skin reddening to the driver and front passenger as the airbags deploy and unfold. The abrasions are similar to friction rope burns or those you might get sliding along a carpet or gymnasium floor. They are not caused by contact with chemicals. They are not permanent and normally heal quickly. However, if you haven't healed significantly within a few days, or if you have any blistering, see your doctor immediately.

- As the airbags deflate you may see some smoke-like particles. The particles are a normal by-product of the process that generates the nontoxic gas used for airbag inflation. These airborne particles may irritate the skin, eyes, nose, or throat. If you have skin or eye irritation, rinse the area with cool water. For nose or throat irritation, move to fresh air. If the irritation continues, see your doctor. If these particles settle on your clothing, follow the garment manufacturer's instructions for cleaning.
- It is not advisable to drive your vehicle after the airbags have deployed. If you are involved in another collision, the airbags will not be in place to protect you.

WARNING!

Deployed airbags and seat belt pretensioners cannot protect you in another collision. Have the airbags, seat belt pretensioner, and seat belt retractor assembly, replaced by an authorized dealer as soon as possible. Also, have the Occupant Classification System serviced as well.

Enhanced Accident Response Feature

If the airbags deploy after an impact and the electrical system remains functional, vehicles equipped with power door locks will unlock automatically. In addition, approximately 5 seconds after the vehicle has stopped moving, the interior lights will illuminate to aid visibility.

NOTE: The interior lights can only be deactivated if the key is removed from the ignition switch or the vehicle is driven.

Maintaining Your Airbag System

WARNING!
<ul style="list-style-type: none"> • Modifications to any part of the airbag system could cause it to fail when you need it. You could be injured if the airbag system is not there to protect you. Do not modify the components or wiring, including adding any kind of badges or stickers to the steering wheel hub trim cover or the upper right side of the instrument panel. Do not modify the front bumper or vehicle body structure. • Do not attempt to modify any part of your advanced airbag system. The airbag may inflate accidentally or may not function properly if modifications are made. Take your vehicle to an authorized dealer for any advanced airbag system service. If your seat including your trim cover and cushion needs to be serviced in any way (including removal or loosening/tightening of seat attachment bolts), take the vehicle to your authorized dealer. Only manufacturer approved seat accessories may be used. If it is necessary to modify an advanced airbag system for persons with disabilities, contact your authorized dealer. • Do not place or hang any items such as add-on video players on the right front passenger seat back. The additional weight may cause the Occupant Classification System to be unable to correctly classify the right front occupant. This could allow the passenger frontal airbag to inflate when it is not desired. • You need proper knee impact protection in a collision. Do not mount or locate any aftermarket equipment on or behind the knee bolsters. • It is dangerous to try to repair any part of the airbag system yourself. Be sure to tell anyone who works on your vehicle that it has an airbag system.

Airbag Warning Light

You will want to have the airbag system ready to inflate for your protection in an impact. The airbag system is designed to be maintenance free. If any of the following occurs, have an authorized dealer service the system promptly:

- Does not come on during the 6 to 8 seconds after the ignition switch is first turned on.
- Remains on after the 6 to 8 second interval.
- Comes on for any period of time while driving.

Event Data Recorder (EDR)

In the event of an airbag deployment, your vehicle is designed to record up to 2-seconds of specific vehicle data parameters (see list below) in an event data recorder prior to the moment of airbag deployment. Please note that such data are ONLY recorded if an airbag deploys, and are otherwise unavailable. In conjunction with other

data gathered during a complete accident investigation, the electronic data may be used by DaimlerChrysler Corporation and others to learn more about the possible causes of crashes and associated injuries in order to assess and improve vehicle performance. In addition to crash investigations initiated by DaimlerChrysler Corporation, such investigations may be requested by customers, insurance carriers, government officials, and professional crash researchers, such as those associated with universities, and with hospital and insurance organizations.

In the event that an investigation is undertaken by DaimlerChrysler Corporation (regardless of initiative), the company or its designated representative will first obtain permission of the appropriate custodial entity for the vehicle (usually the vehicle owner or lessee) before accessing the electronic data stored, unless ordered to download data by a court with legal jurisdiction (i.e., pursuant to a warrant). A copy of the data will be

provided to the custodial entity upon request. General data that does not identify particular vehicles or crashes may be released for incorporation in aggregate crash databases, such as those maintained by the US government and various states. Data of a potentially sensitive nature, such as would identify a particular driver, vehicle, or crash, will be treated confidentially. Confidential data will not be disclosed by DaimlerChrysler Corporation to any third party except when:

1. Used for research purposes, such as to match data with a particular crash record in an aggregate database, provided confidentiality of personal data is thereafter preserved
2. Used in defense of litigation involving a DaimlerChrysler Corporation product
3. Requested by police under a legal warrant
4. Otherwise required by law

Data Parameters that May Be Recorded:

- Diagnostic trouble code(s) and warning lamp status for electronically-controlled safety systems, including the airbag system
- Airbag disable lamp status (if equipped)
- "Time" of airbag deployment (in terms of ignition cycles and vehicle mileage)
- Airbag deployment level (if applicable)
- Seatbelt status
- Brake status (service and parking brakes)
- Accelerator status (including vehicle speed)
- Engine control status (including engine speed)
- Cruise control status
- Traction/stability control status

Child Restraint

Everyone in your vehicle needs to be buckled up all the time — babies and children, too. Every state in the United States and all Canadian provinces require that small children ride in proper restraint systems. This is the law, and you can be prosecuted for ignoring it.

Children 12 years and under should ride properly buckled up in a rear seat, if available. According to crash statistics, children are safer when properly restrained in the rear seats rather than in the front.

There are different sizes and types of restraints for children from newborn size to the child almost large enough for an adult safety belt. Always check the child seat Owner's Manual to ensure you have the right seat for your child. Use the restraint that is correct for your child:

WARNING!

In a collision, an unrestrained child, even a tiny baby, can become a missile inside the vehicle. The force required to hold even an infant on your lap can become so great that you could not hold the child, no matter how strong you are. The child and others could be badly injured. Any child riding in your vehicle should be in a proper restraint for the child's size.

Infants and Child Restraints

- Safety experts recommend that children ride rearward-facing in the vehicle until they are at least one year old **and** weigh at least 20 lbs (9 kg). Two types of child restraints can be used rearward-facing: infant carriers and “convertible” child seats.
- The infant carrier is only used rearward-facing in the vehicle. It is recommended for children who weigh up to about 20 lbs (9 kg). “Convertible” child seats often have a higher weight limit in the rearward-facing direction than infant carriers do, so they can be used rearward-facing by children who weigh more than 20 lbs (9 kg) but are less than one year old. Both types of child restraints are held in the vehicle by the lap/shoulder belt or the LATCH child restraint anchorage system (Refer to LATCH — Child Seat Anchorage System in this section.)
- Rearward-facing child seats must **NEVER** be used in the front seat of a vehicle with the front passenger airbag unless the airbag is turned off. An airbag deployment could cause severe injury or death to infants in this position.

WARNING!

- **Improper installation can lead to failure of an infant or child restraint. It could come loose in a collision. The child could be badly injured or killed. Follow the manufacturer's directions exactly when installing an infant or child restraint.**
- **A rearward facing infant restraint should only be used in a rear seat. A rearward facing infant restraint in the front seat may be struck by a deploying passenger airbag which may cause severe or fatal injury to the infant.**

Here are some tips for getting the most out of your child restraint:

- Before buying any restraint system, make sure that it has a label certifying that it meets all applicable Safety

Standards. The manufacturer also recommends that you try a child restraint in the vehicle seats where you will use it before you buy it.

- The restraint must be appropriate for your child's weight and height. Check the label on the restraint for weight and height limits.
- Carefully follow the instructions that come with the restraint. If you install the restraint improperly, it may not work when you need it.
- Except for the second row center seating position, all passenger seat belts are equipped with cinching latch plates. The second row center position has an automatic locking retractor identified by a distinctive label. Both types of seat belts are designed to keep the lap portion tight around the child restraint so that it is not necessary to use a locking clip. If the seat belt has a cinching latch plate, pulling up on the shoulder portion of the lap/shoulder belt will tighten the belt (the

cinching latch plate will keep the belt tight, however, any seat belt system will loosen with time, so check the belt occasionally and pull it tight if necessary). For the second row center seat belt with the automatic locking retractor, pull the belt from the retractor until there is enough to allow you to pass through the child restraint and slide the latch plate into the buckle. Then, pull the belt until it is fully extracted from the retractor. Allow the belt to return to the retractor, pulling on the excess webbing to tighten the lap portion about the child restraint. For additional information, refer to "Automatic Locking Mode" earlier in this section.

- In the rear seat, you may have trouble tightening the lap/shoulder belt on the child restraint because the buckle or latch plate is too close to the belt path opening on the restraint. Disconnect the latch plate from the buckle and twist the short buckle-end belt several times to shorten it. Insert the latch plate into the buckle with the release button facing out.

- If the belt still cannot be tightened, or if pulling and pushing on the restraint loosens the belt, disconnect the latch plate from the buckle, turn the buckle around, and insert the latch plate into the buckle again. If you still cannot make the child restraint secure, try a different seating position.
- Buckle the child into the restraint exactly as the manufacturer's instructions tell you.
- When your child restraint is not in use, secure it in the vehicle with the seat belt or remove it from the vehicle. Do not leave it loose in the vehicle. In a sudden stop or collision, it could strike the occupants or seat backs and cause serious personal injury.

NOTE: For additional information refer to www.seatcheck.org or call 1-866-SEATCHECK.

Older Children and Child Restraints

Children who weigh more than 20 lbs (9 kg) and who are older than one year can ride forward-facing in the vehicle. Forward-facing child seats and convertible child seats used in the forward-facing direction, are for children who weigh 20 to 40 lbs (9 to 18 kg), and who are older than one year. These child seats are also held in the vehicle by the lap/shoulder belt or the LATCH child restraint anchorage system (Refer to LATCH — Child Seat Anchorage System in this section.)

The belt-positioning booster seat is for children weighing more than 40 lbs (18 kg), but who are still too small to fit the vehicle's seat belts properly. If the child cannot sit with knees bent over the vehicle's seat cushion while the child's back is against the seat back, they should use a belt-positioning booster seat. The child and belt-positioning booster seat are held in the vehicle by the lap/shoulder belt.

Children Too Large for Booster Seats

Children who are large enough to wear the shoulder belt comfortably, and whose legs are long enough to bend over the front of the seat when their back is against the seat back, should use the lap/shoulder belt in a rear seat.

- Make sure that the child is upright in the seat.
- The lap portion should be low on the hips and as snug as possible.
- Check belt fit periodically. A child's squirming or slouching can move the belt out of position.
- If the shoulder belt contacts the face or neck, move the child closer to the center of the vehicle. Never allow a child to put the shoulder belt under an arm or behind their back.

LATCH — Child Seat Anchorage System (Lower Anchors and Tether for Children)

Your vehicle's rear seat is equipped with the child restraint anchorage system called LATCH. The LATCH system provides for the installation of the child restraint without using the vehicle's seat belts, instead securing the child restraint using lower anchorages and upper tether straps from the child restraint to the vehicle structure.

LATCH-compatible child restraint systems are now available. However, because the lower anchorages are to be introduced over a period of years, child restraint systems having attachments for those anchorages will continue to also have features for installation using the vehicle's seat belts. Child restraints having tether straps and hooks for connection to the top tether anchorages have been available for some time. For some older child restraints, many child restraint manufacturers offer add-on tether strap

kits or retro-fit kits. You are urged to take advantage of all the available attachments provided with your child restraint in any vehicle.

All three rear seating positions have lower anchorages that are capable of accommodating LATCH-compatible child seats having flexible, webbing-mounted lower attachments. Child seats with fixed lower attachments must be installed in the outboard positions only. Regardless of the specific type of lower attachment, **NEVER** install LATCH-compatible child seats such that two seats share a common lower anchorage.

If you are installing LATCH-compatible child restraints in adjacent rear seating positions, you can use the LATCH anchors or the vehicle's seat belt for the outboard position, but you must use the vehicle's seat belt at the center position. If your child restraints are not LATCH-compatible, you can only install the child restraints using the vehicle's seat belts. Please refer to the next section for typical installation instructions.

Installing the LATCH-Compatible Child Restraint System

We urge that you carefully follow the directions of the manufacturer when installing your child restraint. Not all child restraint systems will be installed as described here. Again, carefully follow the installation instructions that were provided with the child restraint system.

The rear seat lower anchorages are round bars, located at the rear of the seat cushion where it meets the seat back, and are just visible when you lean into the rear seat to install the child restraint. You will easily feel them if you run your finger along the intersection of the seatback and seat cushion surfaces.

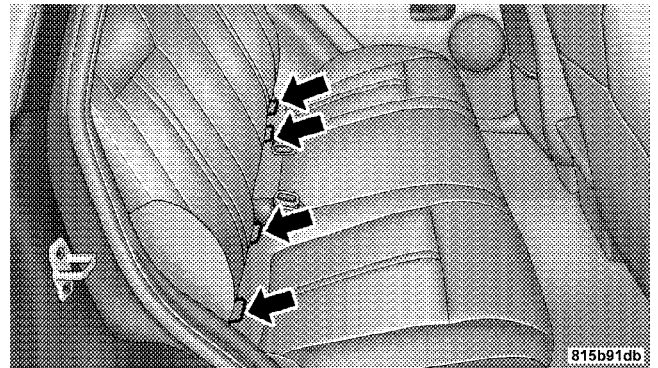

Latch Anchorages

In addition, there are tether strap anchorages behind each rear seating position located on the back of the seat.



Tether Strap Mounting

Many, but not all restraint systems will be equipped with separate straps on each side, with each having a hook or connector for attachment to the lower anchorage and a

means of adjusting the tension in the strap. Forward-facing toddler restraints and some rear-facing infant restraints will also be equipped with a tether strap, a hook for attachment to the tether strap anchorage and a means of adjusting the tension of the strap.

You will first loosen the adjusters on the lower straps and on the tether strap so that you can more easily attach the hooks or connectors to the vehicle anchorages. Next attach the lower hooks or connectors over the top of the anchorage bars, pushing aside the seat cover material. Then, locate the tether anchorage directly behind the seat where you are placing the child restraint and attach the tether strap to the anchorage, being careful to route the tether strap to provide the most direct path between the anchor and the child restraint. Finally, tighten all three straps as you push the child restraint rearward and downward into the seat, removing slack in the straps according to the child restraint manufacturer's instructions.

WARNING!

Improper installation of a child restraint to the LATCH anchorages can lead to failure of an infant or child restraint. The child could be badly injured or killed. Follow the manufacturer's directions exactly when installing an infant or child restraint.

Installing Child Restraints Using the Vehicle Seat Belt

The passenger seat belts are equipped with either cinching latch plates or automatic locking retractors, which are designed to keep the lap portion tight around the child restraint so that it is not necessary to use a locking clip. If the seat belt has a cinching latch plate, pulling up on the shoulder portion of the lap/shoulder belt will tighten the belt. The cinching latch plate will keep the belt tight, however, any seat belt system will loosen with time, so check the belt occasionally and pull it tight if necessary.

If the seat belt has a automatic locking retractor, it will have a distinctive label. Pull the belt from the retractor until there is enough to allow you to pass through the child restraint and slide the latch plate into the buckle. Then, pull the belt until it is all extracted from the retractor. Allow the belt to return to the retractor, pulling on the excess webbing to tighten the lap portion about the child restraint. Refer to "Automatic Locking Mode" earlier in this section.

In the rear seat, you may have trouble tightening the lap/shoulder belt on the child restraint because the buckle or latch plate is too close to the belt path opening on the restraint. Disconnect the latch plate from the buckle and twist the short buckle-end belt several times to shorten it. Insert the latch plate into the buckle with the release button facing out.

If the belt still can't be tightened, or if by pulling and pushing on the restraint loosens the belt, you may need

62 THINGS TO KNOW BEFORE STARTING YOUR VEHICLE

to do something more. Disconnect the latch plate from the buckle, turn the buckle around, and insert the latch plate into the buckle again. If you still can't make the child restraint secure, try a different seating position.

To attach a child restraint tether strap:

Route the tether strap over the seat back and attach the hook to the tether anchor located on the back of the seat. For the outboard seating positions, route the tether over the head rests, and attach the hook to the tether anchor located on the back of the seat.

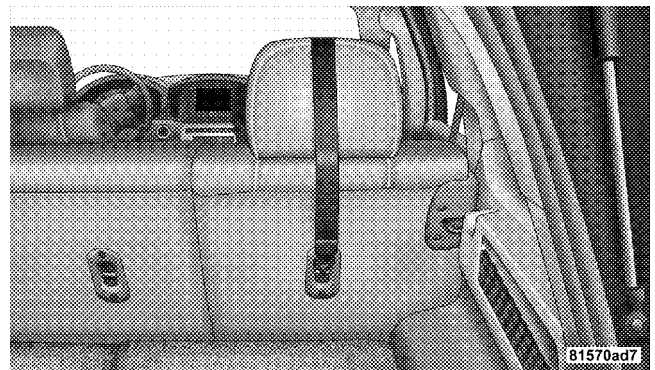

Tether Strap Mounting

WARNING!

An incorrectly anchored tether strap could lead to increased head motion and possible injury to the child. Use only the anchor positions directly behind the child seat to secure a child restraint top tether strap.

Transporting Pets

Airbags deploying in the front seat could harm your pet. An unrestrained pet will be thrown about and possibly injured, or injure a passenger during panic braking or in a collision. Pets should be restrained in the rear seat in pet harnesses or pet carriers that are secured by seat belts.

ENGINE BREAK-IN RECOMMENDATIONS

A long break-in period is not required for the engine in your new vehicle.

Drive moderately during the first 300 miles (500 km). After the initial 60 miles (100 km), speeds up to 50 or 55 mph (80 or 90 km/h) are desirable.

While cruising, brief full-throttle acceleration, within the limits of local traffic laws, contributes to a good break-in. Wide open throttle acceleration in low gear can be detrimental and should be avoided.

The engine oil installed in the engine at the factory is a high quality energy conserving type lubricant. Oil changes should be consistent with anticipated climate conditions under which vehicle operations will occur. The recommended viscosity and quality grades are shown in Section 7 of this manual. NON-DETERGENT OR STRAIGHT MINERAL OILS MUST NEVER BE USED.

A new engine may consume some oil during its first few thousand miles (kilometers) of operation. This should be considered as a normal part of the break-in and not interpreted as an indication of difficulty.

SAFETY TIPS

Exhaust Gas

WARNING!
Exhaust gases can injure or kill. They contain carbon monoxide (CO) which is colorless and odorless. Breathing it can make you unconscious and can eventually poison you. To avoid breathing (CO) follow the safety tips below.

- Do not inhale exhaust gases. They contain carbon monoxide, a colorless and odorless gas which can kill. Never run the engine in a closed area, such as a garage, and never sit in a parked vehicle with the engine running for an extended period. If the vehicle is stopped in an open area with engine running for more than a short period, adjust the ventilation system to force fresh, outside air into the vehicle.
- Guard against carbon monoxide with proper maintenance. Have the exhaust system inspected every time the vehicle is raised. Have any abnormal conditions repaired promptly. Until repaired, drive with all side windows fully open.
- Always run the climate control in panel or floor mode when driving with any windows open, even if only slightly, to help keep fresh air circulating inside vehicle. Otherwise poisonous gases could be drawn into the vehicle.

Safety Checks You Should Make Inside The Vehicle**Seat Belts**

Inspect the belt system periodically, checking for cuts, frays and loose parts. Damaged parts must be replaced immediately. Do not disassemble or modify the system.

Seat belt assemblies must be replaced after an accident if they have been damaged (bent retractor, torn webbing, etc.). If there is any question regarding belt or retractor condition, replace the belt.

Airbag Warning Light

The light should come on and remain on for 6 to 8 seconds as a bulb check when the ignition switch is first turned on. If the bulb is not lit during starting, have it replaced. If the light stays on or comes on while driving, have the system checked by an authorized dealer.

Defrosters

Check operation by selecting the defrost mode and place the blower control on high speed. You should feel the air directed against the windshield.

Safety Checks You Should Make Outside The Vehicle**Tires**

Examine tires for excessive tread wear or uneven wear patterns. Check for stones, nails, glass, or other objects lodged in the tread. Inspect for tread cuts or sidewall cracks. Check wheel nuts for tightness and tires (including spare) for proper pressure.

Lights

Have someone observe the operation of all exterior lights while you work the controls. Check turn signal and high beam indicator lights on the instrument panel.

Fluid Leaks

Check area under vehicle after overnight parking for fuel, coolant, oil or other fluid leaks. Also, if gasoline fumes are detected, the cause should be located and corrected immediately.

UNDERSTANDING THE FEATURES OF YOUR VEHICLE

CONTENTS

■ Mirrors72	■ Hands-Free Communication (UConnect™) — If Equipped76
□ Inside Day/Night Mirror72	□ Operation78
□ Inside Automatic Dimming Mirror — If Equipped73	□ Phone Call Features85
□ Exterior Mirrors Folding Feature74	□ UConnect™ System Features87
□ Outside Mirrors74	□ Advanced Phone Connectivity92
□ Heated Remote Control Mirrors — If Equipped74	□ Things You Should Know About Your UConnect™ System94
□ Power Remote Control Outside Mirrors75	■ Seats99
□ Lighted Vanity Mirrors — If Equipped76	□ Front Manual Seat Adjustment99

68 UNDERSTANDING THE FEATURES OF YOUR VEHICLE

□ Front Seat Adjustment — Recline	100	■ Lights	111
□ Manual Lumbar Support Adjustment	101	□ Interior Lighting	111
□ Head Restraints	101	□ Front Map/Reading Lights	111
□ 8 - Way Driver’s Power Seat	102	□ Multi-Function Control Lever	112
□ 4 - Way Passenger’s Power Seat — If Equipped	102	□ Battery Saver Feature—Exterior/Interior Lights	112
□ Heated Seats—If Equipped	102	□ Headlights And Parking Lights	113
□ 60/40 Split Rear Seat	103	□ Automatic Headlight System — If Equipped	113
■ Driver Memory System — If Equipped	106	□ Smartbeams — If Equipped	114
□ Setting Memory Positions And Linking Remote Keyless Entry Transmitter To Memory	107	□ Instrument Panel And Interior Lights	115
□ Memory Position Recall	108	□ Daytime Running Lights — Canada Only	115
□ To Disable A Transmitter Linked To Memory	109	□ Lights-On Reminder	115
■ To Open And Close The Hood	110	□ Fog Lights — If Equipped	116

<hr/>		UNDERSTANDING THE FEATURES OF YOUR VEHICLE 69	
<input type="checkbox"/> Turn Signals	116	<input type="checkbox"/> Rear Park Assist Sensors	128
<input type="checkbox"/> High Beam Switch	116	<input type="checkbox"/> Rear Park Assist Warning Display	128
<input type="checkbox"/> Passing Light	116	<input type="checkbox"/> Enable/Disable The Rear Park Assist System . .	130
<input type="checkbox"/> Headlight Time Delay	117	<input type="checkbox"/> Service The Rear Park Assist System	130
<input checked="" type="checkbox"/> Windshield Wipers And Washers	117	<input type="checkbox"/> Cleaning The Rear Park Assist System	131
<input type="checkbox"/> Mist	118	<input checked="" type="checkbox"/> Adjustable Pedals — If Equipped	132
<input type="checkbox"/> Speed Sensitive Intermittent Wiper System . . .	118	<input checked="" type="checkbox"/> Electronic Speed Control	134
<input type="checkbox"/> Rain Sensing Wipers—If Equipped	119	<input type="checkbox"/> To Activate	134
<input checked="" type="checkbox"/> Tilt Steering Column	120	<input type="checkbox"/> To Set At a Desired Speed	134
<input checked="" type="checkbox"/> Traction Control — If Equipped	121	<input type="checkbox"/> To Deactivate	134
<input checked="" type="checkbox"/> Electronic Stability Program (ESP)— If Equipped	124	<input type="checkbox"/> To Resume Speed	135
<input checked="" type="checkbox"/> Rear Park Assist System— If Equipped	127	<input type="checkbox"/> To Vary The Speed Setting	135
		<input type="checkbox"/> To Accelerate For Passing	135

70 UNDERSTANDING THE FEATURES OF YOUR VEHICLE

□ Driving Up Or Down Hills	136	□ Closing Sunroof - Express	146
■ Overhead Console — If Equipped	137	□ Pinch Protect Feature	146
□ Courtesy/Reading Lights	137	□ Pinch Protect Override	146
□ Sunglasses Storage	137	□ Venting Sunroof - Express	146
■ Garage Door Opener — If Equipped	138	□ Sunshade Operation	147
□ Programming Homelink	139	□ Wind Buffeting	147
□ Canadian Programming/Gate Programming . .	142	□ Sunroof Maintenance	147
□ Using Homelink	143	□ Ignition Off Operation	147
□ Erasing Homelink Buttons	143	□ Sunroof Fully Closed	147
□ Reprogramming a Single Homelink Button . .	143	■ Power Outlet	148
□ Security	144	■ Cup Holders	149
■ Power Sunroof — If Equipped	145	■ Cargo Area Features	150
□ Opening Sunroof - Express	146	□ Cargo Light	150

<input type="checkbox"/> Rear Storage Compartment	151	<input checked="" type="checkbox"/> Rear Window Features	155
<input type="checkbox"/> Retractable Cargo Area Cover — If Equipped	151	<input type="checkbox"/> Rear Window Wiper/Washer	155
<input type="checkbox"/> Cargo Tie-Down Hooks	153	<input checked="" type="checkbox"/> Roof Luggage Rack — If Equipped	157
<input type="checkbox"/> Cargo Load Floor	154		

MIRRORS

Inside Day/Night Mirror

The mirror should be adjusted to center on the view through the rear window. A two-point pivot system allows for horizontal and vertical adjustment of the mirror. The mirror should be adjusted while set in the day position (toward windshield).

Annoying headlight glare from vehicles behind you can be reduced by moving the small control under the mirror to the night position (toward rear of vehicle).

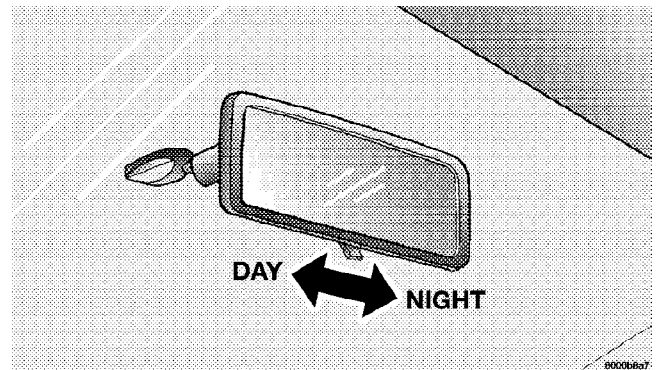

Adjusting Rear View Mirror

Inside Automatic Dimming Mirror — If Equipped

This mirror automatically adjusts for annoying headlight glare from vehicles behind you. You can turn the feature on or off by pressing the button at the base of the mirror. A light in the button will indicate when the dimming feature is activated.

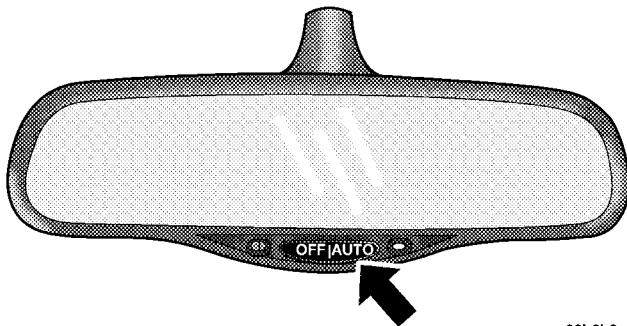

Automatic Dimming Mirror

80b6b3a6

CAUTION!

To avoid damage to the mirror during cleaning, never spray any cleaning solution directly onto the mirror. Apply the solution onto a clean cloth and wipe the mirror clean.

3

Driver's Outside Automatic Dimming Mirror — If Equipped

If your vehicle is equipped with a driver's outside automatic dimming mirror, it operates when the inside automatic dimming mirror is on. This outside mirror operates off the inside mirror switch and will automatically adjust for annoying headlight glare when the inside mirror does.

NOTE: The passenger outside mirror does not have this dimming feature.

Exterior Mirrors Folding Feature

All exterior mirrors are hinged and may be moved either forward or rearward to resist damage. The hinges have three detent positions; full forward, full rearward, and normal.

Outside Mirrors

To receive maximum benefit, adjust the outside mirrors to center on the adjacent lane of traffic with a slight overlap of the view obtained on the inside mirror.

WARNING!

Vehicles and other objects seen in the right side convex mirror will look smaller and farther away than they really are. Relying too much on your right side mirror could cause you to collide with another vehicle or other objects. Use your inside mirror when judging the size or distance of a vehicle seen in the right side mirror.

Heated Remote Control Mirrors — If Equipped



These mirrors are heated to melt frost or ice. This feature is activated whenever you turn on the rear window defrost.

Power Remote Control Outside Mirrors

The power mirror switch is located on the driver's door trim panel next to the power door lock switch. A rotary knob selects the left mirror, right mirror, or off position.

After selecting a mirror move the knob in the same direction you want the mirror to move. Use the center off position to guard against accidentally moving a mirror position.

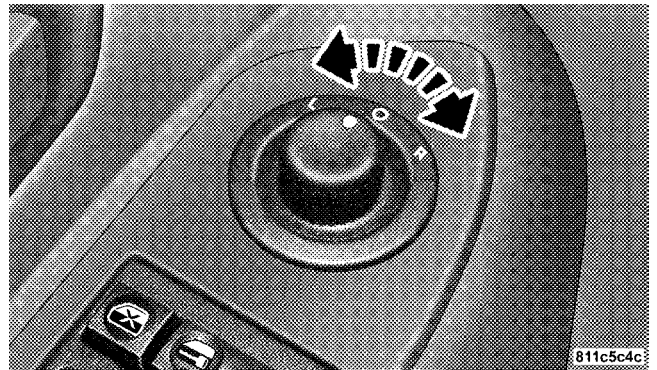
**Power Mirror Switches**

Power mirror preselected positions can be controlled by the optional Memory Seat Feature. Refer to "Seats" section for details.

Lighted Vanity Mirrors — If Equipped

To access a lighted vanity mirror, flip down one of the visors.

Lift the cover to reveal the mirror. The light will turn on automatically.

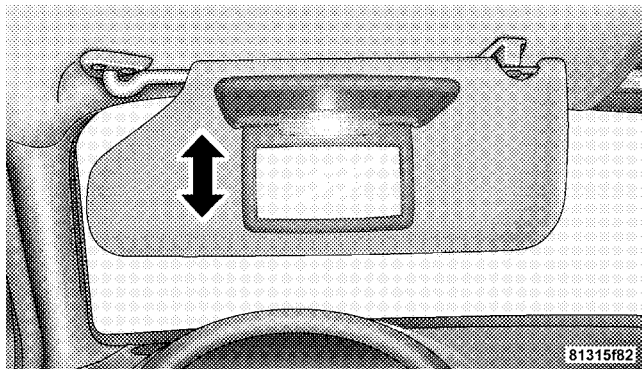

Lighted Vanity Mirror

HANDS-FREE COMMUNICATION (UConnect™) — IF EQUIPPED

UConnect™ is a voice-activated, hands-free, in vehicle communications system. UConnect™ allows you to dial a phone number with your cellular phone* using simple voice commands (e.g., "Call ... Mike ...Work" or "Dial ... 248-555-1212"). Your cellular phone's audio is transmitted through your vehicle's audio system; the system will automatically mute your radio when using the UConnect™ system.

NOTE: The UConnect™ system use requires a cellular phone equipped with the Bluetooth "Hands-Free Profile," version 0.96 or higher.

For UConnect Customer Support call 1-877-855-8400 or visit the UConnect website (www.chrysler.com/uconnect).

UConnect™ allows you to transfer calls between the system and your cellular phone as you enter or exit your vehicle, and enables you to mute the system’s microphone for private conversation.

The UConnect™ phonebook enables you to store up to 32 names and four numbers per name. Each language has a separate 32 name phonebook accessible only in that language. This system is driven through your Bluetooth™ Hands-Free profile cellular phone. UConnect™ features Bluetooth™ technology - the global standard that enables different electronic devices to connect to each other without wires or a docking station, so UConnect works no matter where you stow your cellular phone (be it your purse, pocket, or briefcase), as long as your phone is turned on and has been paired to the vehicle’s UConnect™ system. The UConnect™ system allows up to seven cellular phones to be linked to system. Only one linked (or paired) cellular phone can be used

with the system at a time. The system is available in English, Spanish, or French languages (as equipped).

The rearview mirror contains the microphone for the system and the control buttons that will enable you to access the system. The diagram below shows the mirror with the appropriate buttons. Individual button behavior is discussed in the "Operation" section.



UConnect™ Switches

8105b20d

The UConnect™ system can be used with any Hands-Free Profile certified Bluetooth™ cellular phone. If your cellular phone supports a different profile (eg., Headset Profile), you may not be able to use any UConnect™ features. Refer to your cellular service provider or the phone manufacturer for details.

The UConnect™ system is fully integrated with the vehicle's audio system. The volume of the UConnect™ system can either be adjusted from the radio volume control knob, or from the steering wheel radio control (right switch), if so equipped.

The radio display will be used for visual prompts from the UConnect™ system such as "CELL" or caller ID on certain radios.

Operation

Voice commands can be used to operate the UConnect™ system and to navigate through the UConnect™ menu structure. Voice commands are required after most UConnect™ system prompts. You will be prompted for a specific command and then guided through the available options.

- Prior to giving a voice command, one must wait for the voice on beep, which follows the "Ready" prompt or another prompt.
- For certain operations, compound commands can be used. For example, instead of saying "Setup" and then "Phone Pairing," the following compound command can be said: "Setup Phone Pairing."

- For each of the feature explanation in this section, only the combined form of the voice command is given. You can also break the commands into parts and say each part of the command, when you are asked for it. For example, you can either use the combined form voice command "Phonebook New Entry," or you can break the combined form command into two voice commands: "Phonebook" and "New Entry." Please remember, the UConnect™ system works best when you talk in a normal conversational tone, as if speaking to someone sitting eight feet away from you.

Voice Command Tree

Refer to "Voice Tree" at the end of this section.

Help Command

If you need assistance at any prompt or if you want to know what your options are at any prompt, say "Help" following the voice on beep. The UConnect™ system will play all the options at any prompt if you ask for help.

To activate the UConnect™ system from idle, simply press the 'Phone' button and follow audible prompts for directions. All UConnect™ system sessions begin with a press of the 'Phone' button on the mirror.

Cancel Command

At any prompt, after the voice on beep, you can say "Cancel" and you will be returned to the main menu. However, in a few instances the system will take you back to the previous menu.

Pair (Link) UConnect™ System to a Cellular Phone

To begin using your UConnect™ system, you must pair your compatible Bluetooth™ enabled cellular phone (refer to "Introduction" section to learn about the phone type). To complete the pairing process, you will need to reference your cellular phone owner's manual. One of the following vehicle specific websites may also provide detailed instructions for pairing with the brand of phone that you have:

NOTE:

- www.chrysler.com/uconnect
- www.dodge.com/uconnect
- www.jeep.com/uconnect

The following are general phone to UConnect™ System pairing instructions:

- Press the 'Phone' button to begin.
- After the "Ready" prompt and the following beep, say "Setup Phone Pairing."
- When prompted, after the voice on beep, say "Pair a Phone."
- You will be asked to say a four-digit pin number which you will later need to enter into your cellular. You can enter any four-digit pin number. You will not need to remember this pin number after the initial pairing process.
- The UConnect™ system will then prompt you to begin the cellular phone pairing process on your cellular phone. Before attempting to pair phone, please see your cellular phone's user manual (Bluetooth section) for instructions on how to complete this step.
- For identification purposes, you will be prompted to give the UConnect™ system a name for your cellular phone. Each cellular phone that is paired should be given a unique phone name.
- You will then be asked to give your cellular phone a priority level between 1 and 7, 1 being the highest priority. You can pair up to seven cellular phones to your UConnect™ system. However, at any given time, only one cellular phone can be in use, connected to your UConnect™ System. The priority allows the UConnect™ system to know which cellular phone to use if multiple cellular phones are in the vehicle at the same time. For example, if priority 3 and priority 5

phones are present in the vehicle, the UConnect™ system will use the priority 3 cellular phone when you make a call. You can select to use a lower priority cellular phone at any time (refer to "Advanced Phone Connectivity" section).

Dial by Saying a Number

- Press the 'Phone' button to begin.
- After the "Ready" prompt and the following beep, say "Dial."
- System will prompt you to say the number you want call.
- For example, you can say "234-567-8901." The phone number that you enter must be of valid length and combination. The UConnect™ limits the user from dialing invalid combination of numbers. For example,

234-567-890 is nine digits long, which is not a valid phone number - the closest valid phone number has ten digits.

- The UConnect™ system will confirm the phone number and then dial. The number will appear in the display of certain radios.

Call by Saying a Name

- Press the "Phone" button to begin.
- After the "Ready" prompt and the following beep, say "Call."
- System will prompt you to say the name of the person you want call.
- After the "Ready" prompt and the following beep, say the name of the person you want to call. For example,

you can say "John Doe," where John Doe is a previously stored name entry in the UConnect™ phonebook. Refer to section "Add Names to Your UConnect™ Phonebook," to learn how to store a name in the phonebook.

- The UConnect™ system will confirm the name and then dial the corresponding phone number, which may appear in the display of certain radios.

Add Names to Your UConnect™ Phonebook

NOTE: Adding names to phonebook is recommended when vehicle is not in motion.

- Press the "Phone" button to begin.
- After the "Ready" prompt and the following beep, say "Phonebook New Entry."

- When prompted, say the name of the new entry. Use of long names helps the voice recognition and is recommended. For example, say "Robert Smith" or "Robert" instead of "Bob."
- When prompted, enter the number designation (e.g.: "Home," "Work," "Mobile," or "Pager"). This will allow you to store multiple numbers for each phonebook entry, if desired.
- When prompted, recite the phone number for the phonebook entry that you are adding.

After you are finished adding an entry into the phonebook, you will be given the opportunity to add more phone numbers to the current entry or to return to the main menu.

The UConnect™ system will allow you to enter up to 32 names in the phonebook with each name having up to

four associated phone numbers and designations. Each language has a separate 32 name phonebook accessible only in that language.

Edit Entries in the UConnect™ Phonebook

NOTE: Adding names to phonebook is recommended when vehicle is not in motion.

- Press the 'Phone' button to begin.
- After the "Ready" prompt and the following beep, say "Phonebook Edit."
- You will then be asked for the name of the phonebook entry that you wish to edit.
- Next, choose the number designation (home, work, mobile, or pager) that you wish to edit.
- When prompted, recite the new phone number for the phonebook entry that you are editing.

After you are finished editing an entry in the phonebook, you will be given the opportunities to edit another entry in the phonebook, call the number you just edited, or return to the main menu.

"Phonebook Edit" can be used to add another phone number to a name entry that already exists in the phonebook. For example, the entry John Doe may have a mobile and a home number, but you can add John Doe's work number later using the "Phonebook Edit" feature.

Delete Entries in the UConnect™ Phonebook

- Press the 'Phone' button to begin.
- After the "Ready" prompt and the following beep, say "Phonebook Delete."
- After you enter the Phonebook Delete menu, you will then be asked for the name of the entry that you wish to delete. You can either say the name of a phonebook entry that you wish to delete or you can say "List

Names" to hear a list of the entries in the phonebook from which you choose. To select one of the entries from the list, press the "Voice Recognition" button while the UConnect™ system is playing the desired entry and say "Delete."

- After you enter the name, the UConnect™ system will ask you which designation you wish to delete: home, work, mobile or pager. Say the designation you wish to delete.

After confirmation, the phonebook entries will be deleted. Note that only the phonebook in the current language is deleted.

Delete All Entries in the UConnect™ Phonebook

- Press the 'Phone' button to begin.
- After the "Ready" prompt and the following beep, say "Phonebook Erase All."
- The UConnect™ system will ask you to verify that you wish to delete all the entries from the phonebook.

- After confirmation, the phonebook entries will be deleted.

List All Names in the UConnect™ Phonebook

- Press the 'Phone' button to begin.
- After the "Ready" prompt and the following beep, say "Phonebook List Names."
- The UConnect™ system will play the names of all the phonebook entries.
- To call one of the names in the list, press the "Voice Recognition" button during the playing of the desired name and say "Call". NOTE: the user can also exercise "Edit" or "Delete" operations at this point.
- The UConnect™ system will then prompt you as to number designation you wish to call.
- The selected number will be dialed.

Phone Call Features

The following features can be accessed through the UConnect™ system if the feature(s) are available on your cellular service plan. For example, if your cellular service plan provides three-way calling, this feature can be accessed through the UConnect™ system. Check with your cellular service provider for the features that you have.

Answer or Reject an Incoming Call - No Call Currently in Progress

When you receive a call on your cellular phone, the UConnect™ system will interrupt the vehicle audio system, if on, and will ask if you would like to answer the call. To reject the call, press and hold the 'Phone' button until you hear a single beep indicating that the incoming call was rejected.

Answer or Reject an Incoming Call - Call Currently in Progress

If a call is currently in progress and you have another incoming call, you will hear the same network tones for call waiting that you normally hear when using your cell phone. Press the 'Phone' button to place the current call on hold and answer the incoming call. NOTE: The UConnect™ system compatible phones in market today do not support rejecting an incoming call when another call is in progress. Therefore, the user can only either answer an incoming call or ignore it.

Making a Second Call while Current Call in Progress

To make a second call while you are currently in a call, press the 'Voice Recognition' button and say "Dial" or "Call" followed by the phone number or phonebook entry you wish to call. The first call will be on hold while the

second call is in progress. To go back to the first call, refer to section "Toggling Between Two Calls." To combine two calls, refer to section "Conference Call."

Place/Retrieve a Call from Hold

To put a call on hold, press the 'Phone' button until you hear a single beep which will indicate that the call has been placed on hold. To bring the call back from hold, press and hold the 'Phone' button until you hear a single beep.

Toggling Between Calls

If two calls are in progress (one active and one on hold), press the 'Phone' button until you hear a single beep indicating that the active and hold status of the two calls have switched. Only one call can be placed on hold at one time.

Conference Call

When two calls are in progress (one active and one on hold), press and hold the 'Phone' button until you hear a double beep indicating that the two calls have been joined into one conference call.

Three-Way Calling

To initiate three-way calling, press the 'Voice Recognition' button while a call is in progress and make a second phone call as described in section "Making a Second Call while Current Call in Progress." After the second call has established, press and hold the 'Phone' button until you hear a double beep indicating that the two calls have been joined into one conference call.

Call Termination

To end a call in progress, momentarily press the 'Phone' button. Only the active call(s) will be terminated and if there is a call on hold, it will become the new active call.

Redial

- Press the 'Phone' button to begin.
- After the "Ready" prompt and the following beep, say "Redial."
- The UConnect™ system will call the last number that was dialed on your cellular phone. Note: this may not be the last number dialed from the UConnect™ system.

Call Continuation

Call continuation is progression of a phone call on UConnect™ system after the vehicle ignition key has been switched to off. Call continuation functionality available on the vehicle can be any one of three types:

- After ignition key is switched off, a call can continue on the UConnect™ system either until the call ends or

until the vehicle battery condition dictates cessation of the call on the UConnect™ system and transfer of the call to the mobile phone.

- After ignition key is switched to off, a call can continue on the UConnect™ system for certain duration, after which the call is automatically transferred from the UConnect™ system to the mobile phone.
- An active call is automatically transferred to the mobile phone after ignition key is switched to off.

3

UConnect™ System Features

Language Selection

To change the language that the UConnect™ system is using,

- Press the 'Phone' button to begin.

- After the "Ready" prompt and the following beep, say the name of the language you wish to switch to (English, Espanol, or Francais, if so equipped).
- Continue to follow the system prompts to complete language selection.

After selecting one of the languages, all prompts and voice commands will be in that language.

NOTE: After every UConnect™ language change operation, only the language specific 32 name phonebook is usable. The phone pairing is not language specific and usable across all languages.

Emergency Assistance

If you are in an emergency and the mobile phone is reachable:

- Pick up the phone and manually dial the emergency number for your area.

If the phone is not reachable and the UConnect™ system is operational, you may reach the emergency number as follows:

- Press the 'Phone' button to begin.
- After the "Ready" prompt and the following beep, say "Emergency" and the UConnect™ system will instruct the paired cellular phone to call the emergency number. This feature is only supported in the USA.

NOTE: The emergency number dialed is based on the Country where the vehicle is purchased (911 for USA/Canada and 060 for Mexico). The number called may not be applicable with the available cellular service and area.

The UConnect™ system does slightly lower your chances of successfully making a phone call as to that for the cell phone directly.

Your phone must be turned on and paired to the UConnect™ system to allow use of this vehicle feature in emergency situations when the cell phone has network coverage and stays paired to the UConnect™ system.

Towing Assistance

If you need towing assistance,

- Press the 'Phone' button to begin.
- After the "Ready" prompt and the following beep, say "Towing Assistance."

NOTE: The Towing Assistance number dialed is based on the Country where the vehicle is purchased (1-800-528-2069 for USA, 1-877-213-4525 for Canada, 55-14-3454 for Mexico city and 1-800-712-3040 for outside Mexico city in Mexico).

Please refer to the 24-Hour Towing Assistance coverage details in the DaimlerChrysler Corporation 24-Hour Towing Assistance Program Guide.

Paging

To learn how to page, refer to section "Working with Automated Systems." Paging works properly except for pagers of certain companies which time-out a little too soon to work properly with the UConnect™ system.

Voice Mail Calling

To learn how to access your voice mail, refer to section "Working with Automated Systems."

Working with Automated Systems

This method is designed to be used in instances where one generally has to press numbers on the cellular phone keypad while navigating through an automated telephony system.

You can use your UConnect™ system to access a voice-mail system or an automated service, such as, paging service or automated customer service. Some services require immediate response selection, in some instances, that may be too quick for use of UConnect™ system.

When calling a number with your UConnect™ system that normally requires you to enter in a touch-tone sequence on your cellular phone keypad, you can push the 'Voice Recognition' button and say the sequence you wish to enter followed by the word "Send." For example, if required to enter your pin number followed with a pound 3 7 4 6 #, you can press the 'Voice Recognition' button and say "3 7 4 6 # Send." Saying a number, or sequence of numbers, followed by "Send" is also to be used to navigate through an automated customer service center menu structure and to leave a number on a pager.

Barge In - Overriding Prompts

The 'Voice Recognition' button can be used when you wish to skip part of a prompt and issue your voice recognition command immediately. For example, if a prompt is playing "Would you like to pair a phone, clear a...," you could press the 'Voice Recognition' button and say "Pair a Phone" to select that option without having to listen to the rest of the voice prompt.

Turning Confirmation Prompts On/Off

Turning confirmation prompts off will stop the system from confirming your choices (e.g. the UConnect™ system will not repeat a phone number before you dial it).

- Press the 'Phone' button to begin.
- After the "Ready" prompt and the following beep, say "Setup Confirmations." The UConnect™ system will play the current confirmation prompt status and you will be given the choice to change it.

Phone and Network Status Indicators

The UConnect™ system will provide notification to inform you if your cellular phone is in roaming status, has low signal strength, or has a low battery when you are trying to place a phone call.

Dialing Using the Cellular Phone Keypad

You can dial a phone number with your cellular phone keypad and still use the UConnect™ system (while

dialing via the cell phone keypad, the user must exercise caution and take precautionary safety measures). By dialing a number with your paired Bluetooth™ cellular phone, the audio will be played through your vehicle's audio system. The UConnect™ system will work the same as if you dial the number using voice recognition.

NOTE: Certain brands of mobile phones do not send the dial ring to the UConnect™ system to play it on the vehicle audio system, so you will not hear it. Under this situation, after successfully dialing a number, the user may feel that the call did not go through even though the call is in progress. Once your call is answered, you will hear the audio.

Mute/Un-mute (Mute off)

When you mute the UConnect™ system, you will still be able to hear the conversation coming from the other party, but the other party will not be able to hear you. In order to mute the UConnect™ system:

- Press the 'Voice Recognition' button.
- After the "Ready" prompt and the following beep, say "Mute."

In order to un-mute the UConnect™ system:

- Press the 'Voice Recognition' button.
- After the "Ready" prompt and the following beep, say "Mute-off."

Information Service

When using AT&T Wireless Service, dialing to phone number "#121," you can access voice activated automated system to receive news, weather, stocks, traffic, etc. related information.

Advanced Phone Connectivity

Transfer Call to and from Cellular Phone

The UConnect™ system allows on going calls to be transferred to your cellular phone to the UConnect™ system without terminating the call. To transfer an ongoing call from your UConnect™ paired cellular phone to the UConnect™ system or vice-versa, press the 'Voice Recognition' button and say "Transfer Call."

Connect or Disconnect Link Between the UConnect™ System and Cellular Phone

Your cellular phone can be paired with many different electronic devices, but can only be actively "connected" with one electronic device at a time.

If you would like to connect or disconnect the Bluetooth™ connection between a UConnect™ paired cellular phone and the UConnect™ system, follow the instruction described in your cellular phone user's manual.

List Paired Cellular Phone Names

- Press the 'Phone' button to begin.
- After the "Ready" prompt and the following beep, say "Setup Phone pairing".
- When prompted, say "List Phones".
- The UConnect™ system will play the phone names of all paired cellular phones in order from the highest to the lowest priority. To "select" or "delete" a paired phone being announced, press the 'Voice recognition' button and say "Select" or "Delete". Also, see next two sections for alternate way of doing this.

Select another Cellular Phone

This feature allows you to select and start using another phone with the UConnect™ system. The phone must have been previously paired to the UConnect™ system that you want to use it with.

- Press the 'Phone' button to begin.
- After the "Ready" prompt and the following beep, say "Setup Select Phone."
- The phone names (along with priority numbers) will be played.
- When prompted say the priority number of the cellular phone you wish to select. You can also press the 'Voice Recognition' button anytime while the list is being played and say the priority number.
- The selected phone will be used for the next phone call. If the selected phone is not available, the UConnect™ system will return to using the highest priority phone present in or near (approximately within 30 feet) the vehicle.

Delete UConnect™ Paired Cellular Phones

- Press the 'Phone' button to begin.
- After the "Ready" prompt and the following beep, say "Setup Phone Pairing."
- At the next prompt, say "Delete."
- The phone names (along with priority numbers) will be played.
- When prompted say the priority number of the cellular phone (or "All" to delete all phones) you wish to delete. You can also press the 'Voice Recognition' button anytime while the list is being played and say the priority number.

Things You Should Know About Your UConnect™ System

Voice Recognition (VR)

- Always wait for the beep before speaking.
- Speak normally, without pausing, just as you would speak to a person sitting approximately eight (8) feet away from you.
- Make sure that no one other than you is speaking during a voice recognition period.
- Performance is maximized under:
 - low-to-medium blower setting,
 - low-to-medium vehicle speed,
 - low road noise,
 - smooth road surface,
 - fully closed windows,
 - dry weather condition.
- Even though the system is designed for users speaking in North American English and Spanish accents, the system may not always work for some.
- When navigating through an automated system, such as, voice mail, or when sending a page, at the end of speaking the digit string, make sure to say "send."
- Storing names in phonebook when vehicle is not in motion is recommended.
- It is not recommended to store similar sounding names in the UConnect™ phonebook.
- UConnect™ phonebook name tag recognition rate is optimized for the person who stored the name in the phonebook.
- You can say "O" (letter "O") for "0" (zero). "800" must be spoken "eight-zero-zero."
- Even though international dialing for most number combinations is supported, some shortcut dialing number combinations may not be supported.

Far End Audio Performance

- Audio quality is maximized under:
 - low-to-medium blower setting,
 - low-to-medium vehicle speed,
 - low road noise,
 - smooth road surface,
 - fully closed windows, and
 - dry weather condition.
- Operation from driver seat.
- Performance, such as, audio clarity, echo, and loudness to a large degree, rely on the phone and network, and not the UConnect™ system.
- Echo at far end can sometime be reduced by lowering the in-vehicle audio volume.

Bluetooth Communication Link

Cellular phones have been found to occasionally loose connection to the UConnect™ system. When this happens, the connection can generally be re-established by switching the phone off/on. Your cell phone is recommended to remain in Bluetooth "on" mode.

Reset

In rare instances, it may be necessary to reset the UConnect™ system. The reset feature is exercised by pressing and holding the 'UConnect™' and 'Voice Recognition' buttons simultaneously for 15 seconds. Normally, you do not need to exercise this feature.

Power-Up

After switching ignition key from off to either On or ACC position, or after a reset, you must wait at least five (5) seconds prior to using the system.

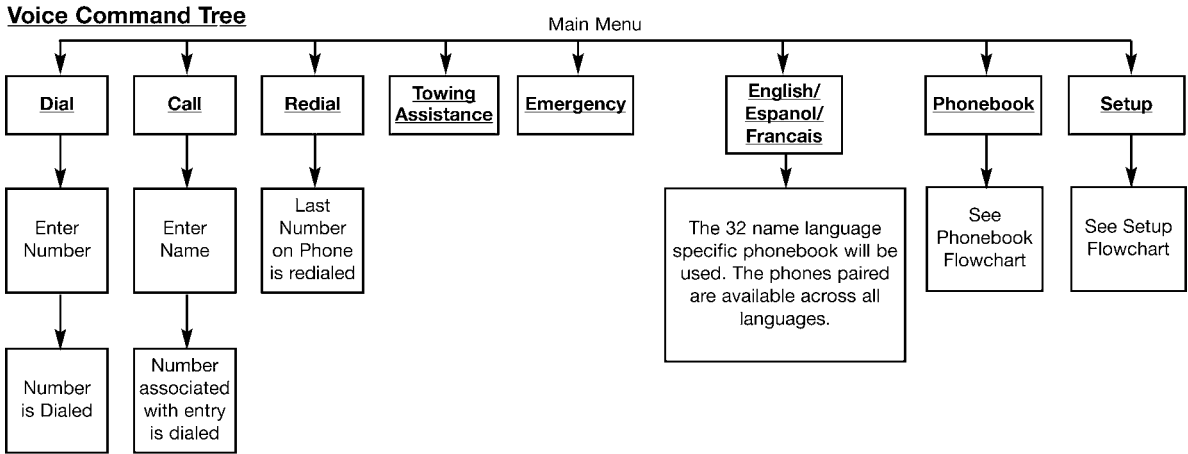

Note: Available Voice commands are shown in bold face and are underlined.

Voice Tree – Phonebook

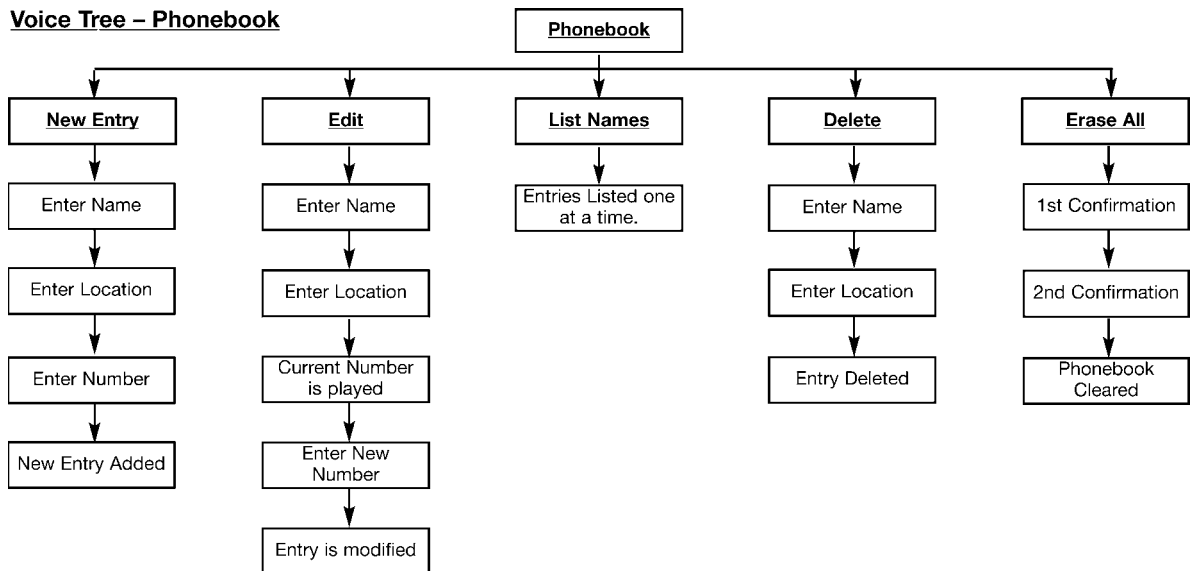

Note: Available Voice commands are shown in bold face and are underlined.

8131b294

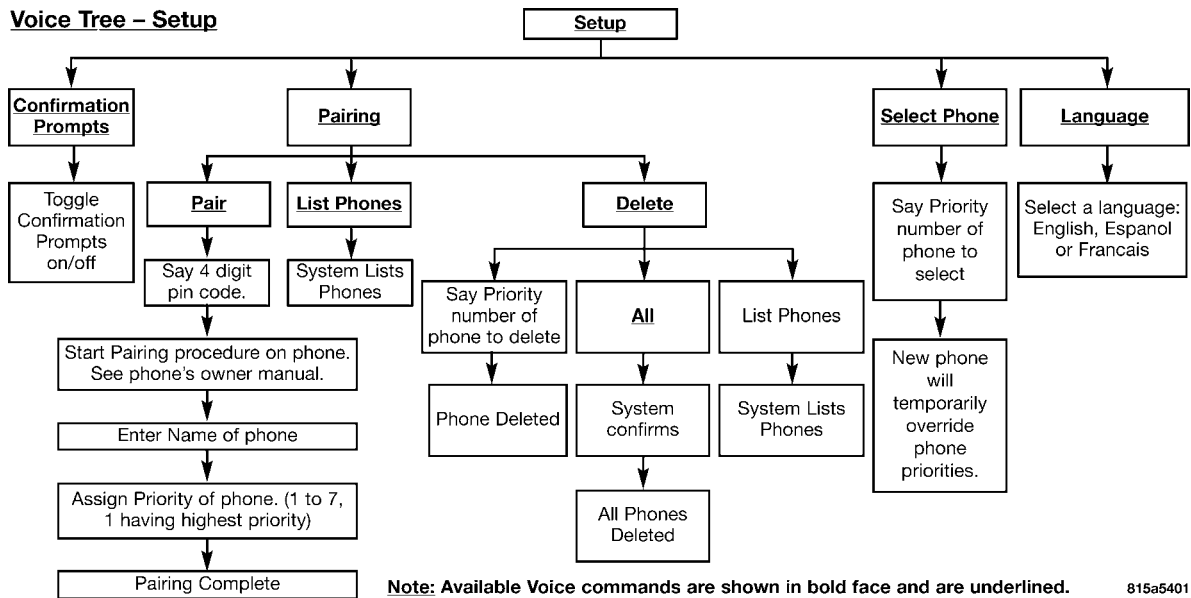

	North American English
Primary	Alternate(s)
Zero	Oh
Add location	Add new
All	All of them
Confirmation prompts	Confirmations prompts
Delete a name	Delete
Language	Select language
List names	List all
List paired phones	List phones
Pager	Beeper
Phone pairing	Pairing
Phonebook	Phone book
Return to main menu	Return. Main menu
Select phone	select
Set up	Phone settings phone set up

SEATS

WARNING!

Adjusting a seat while the vehicle is moving is dangerous. The sudden movement of the seat could cause you to lose control. The seat belt might not be properly adjusted and you could be injured. Adjust any seat only while the vehicle is parked.

3

Front Manual Seat Adjustment

Move the seat forward or rearward using the adjustment bar. Lift up on the bar located on the front of the seat near the floor. Position the seat and be sure the latch engages fully.

Front Seat Adjustment — Recline

To adjust the seatback, lift the lever located on the outboard side of the seat, lean back, and release the lever at the desired position. To return the seatback, lift the lever, lean forward, and release the lever.

WARNING!

Do not ride with the seatback reclined so that the seat belt is no longer resting against your chest. In a collision you could slide under the seat belt and be seriously or even fatally injured. Use the recliner only when the vehicle is parked.

WARNING!

- It is extremely dangerous to ride in a cargo area, inside or outside of a vehicle. In a collision, people riding in these areas are more likely to be seriously injured or killed.
- Do not allow people to ride in any area of your vehicle that is not equipped with seats and seat belts.
- Be sure everyone in your vehicle is in a seat and using a seat belt properly.

Manual Lumbar Support Adjustment

The manual lumbar support adjustment lever is located on the right side of the driver's seat and on the left side of the passenger's seat. Moving the lumbar control lever fore and aft increases or decreases the lumbar support.

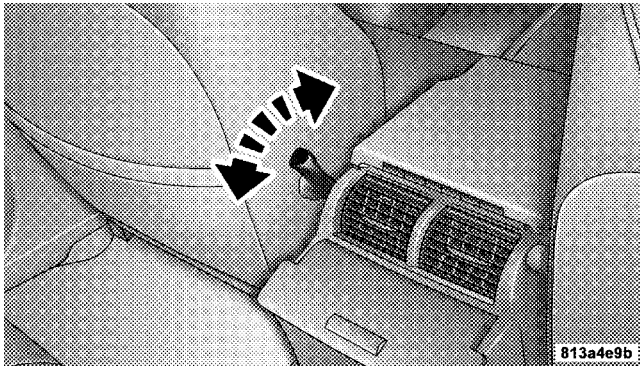

Manual Lumbar Control

Head Restraints

Head restraints can reduce the risk of whiplash injury in the event of impact from the rear. Adjustable head restraints should be adjusted so that the upper edge is as high as practical. The head restraints have a locking button which must be pushed in to lower the head restraint to all positions. The restraints may be raised without pushing in the button.

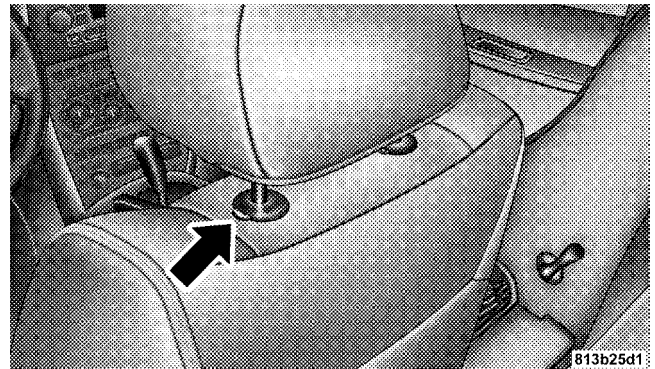

Adjustable Head Restraints

8 - Way Driver's Power Seat

The driver's power seat switches are located on the outboard side of the driver's seat lower side trim. The bottom switch controls up/down, forward/rearward, and tilt adjustment. The top switch controls the seatback recline adjustment.

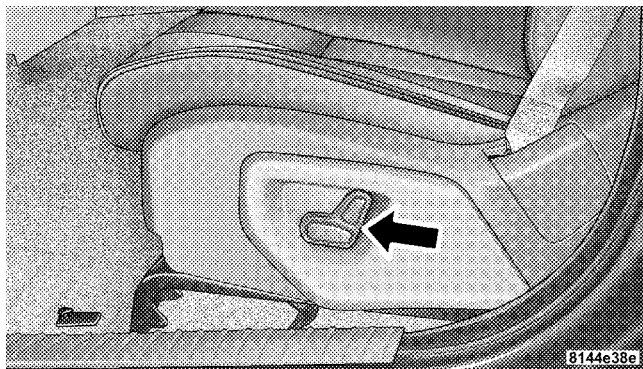

Power Seat Switches

4 - Way Passenger's Power Seat — If Equipped

The front passenger's power seat switches are located on the outboard side of the passenger seat lower side trim. The bottom switch controls forward/rearward adjustment. The top switch controls the seatback recline adjustment.

NOTE: The 4 - way seat does not have an up/down adjustment.

Heated Seats—If Equipped

Heated seats provide comfort and warmth on cold days and can help soothe sore muscles and backs. The heaters provide the same heat level for both cushion and back. The front driver and passenger seats are heated. The controls for each heater are located near the bottom center of the instrument panel. After turning on the ignition, you can choose from High, Off, or Low heat settings. Amber LEDs in the top portion of each switch

indicate the level of heat in use. Two LEDs are illuminated for high, one for low, and none for off. Pressing the switch once will select high-level heating.

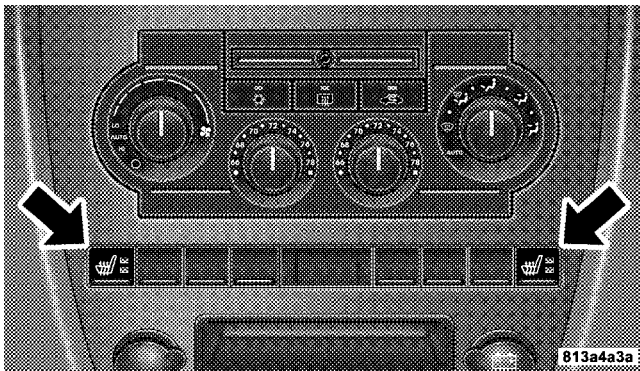

Heated Seat Switches

Pressing the switch a second time will select low-level heating. Pressing the switch a third time will shut the heating elements off.

When high-temperature heating is selected, the heaters provide a boosted heat level during the first five minutes of operation after heating is activated. The heat output then drops to the normal high-temperature level. If high-level heating is selected, the system will automatically switch to the low level after two hours of continuous operation. At that time, the number of illuminated LEDs changes from two to one, indicating the change. Operation on the low setting also turns off automatically after two hours.

NOTE: Once a heat setting is selected, heat will be felt within two to five minutes.

60/40 Split Rear Seat

To Lower Rear Seat

Either side of the rear seat can be lowered to allow for extended cargo space and still maintain some rear seating room.

NOTE: Be sure that the front seats are fully upright and positioned forward. This will allow the rear seatback to fold down easily.

1. Pull the release strap (toward the front of the vehicle) to release.

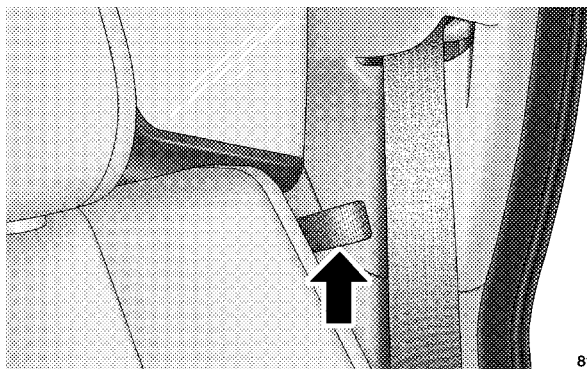

Rear Seat Release

8144df60

2. Fold the rear seat completely forward.

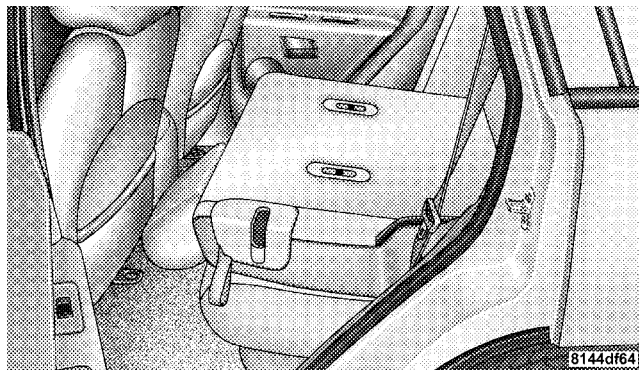

Folding Rear Seat

To Raise Rear Seat

Raise the rear seatback and lock it into place. If interference from the cargo area prevents the seatback from fully locking, you will have difficulty returning the seat to its

proper position. The automatically folding rear head restraints must be manually returned from the folded position to the seating position.

WARNING!

The cargo area in the rear of the vehicle (with the rear seatbacks in the locked-up or folded down position) should not be used as a play area by children when the vehicle is in motion. They could be seriously injured in an accident. Children should be seated and using the proper restraint system.

Storage — Rear Seat Armrest (If Equipped)

The rear seat may be equipped with a center storage armrest.

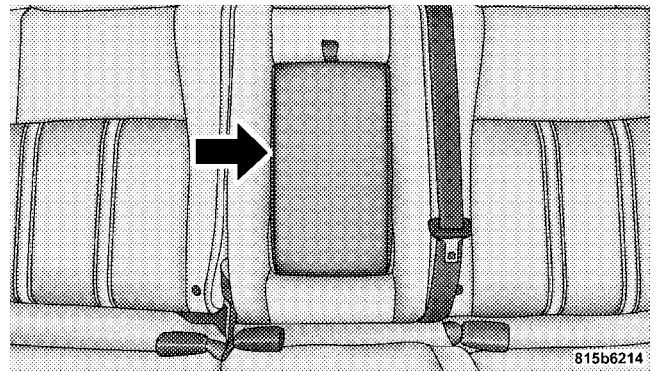

Rear Seat Armrest

Press the latch and lift the top of the armrest to access the storage bin. The storage bin has an integrated cargo net.

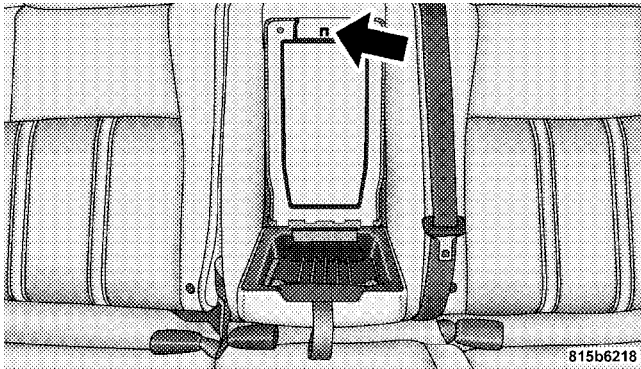

Armrest Storage Bin

DRIVER MEMORY SYSTEM — IF EQUIPPED

Once programmed, the memory buttons 1 and 2 on the driver's door panel can be used to recall the driver's seat, driver's outside mirror, adjustable brake and accelerator pedals, and radio station preset settings. Your Remote Keyless Entry transmitters can also be programmed to recall the same positions when the "Unlock" button is pressed.

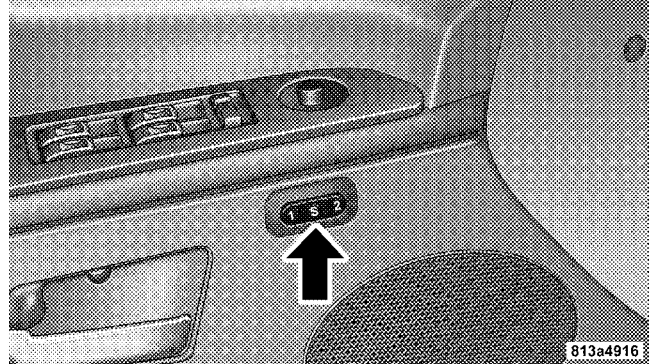

Driver Memory Switches

Your vehicle may have been delivered with two Remote Keyless Entry transmitters. One or both transmitters can be linked to either memory position. The memory system can accommodate up to four transmitters, each one linked to either of the two memory positions.

Setting Memory Positions and Linking Remote Keyless Entry Transmitter to Memory

NOTE: Each time the SET (S) button and a numbered button (1 or 2) are pressed, you erase the memory settings for that button and store a new one.

1. Insert the ignition key and turn the ignition switch to the ON position.
2. Press the driver door memory button number 1 if you are setting the memory for driver 1, or button number 2 if you are setting the memory for driver 2. The system will recall any stored settings. Wait for the system to complete the memory recall before continuing to step 3.
3. Adjust the driver's seat, recliner, and driver's side view mirror to the desired positions.
4. Adjust the brake and accelerator pedals to the desired positions.
5. Turn on the radio and set the radio station presets (up to 10 AM and 10 FM stations can be set).
6. Turn the ignition switch to the OFF position and remove the key.
7. Press and release the SET (S) button located on the driver's door.
8. Within 5 seconds, press and release memory button 1 or 2 on the driver's door. The next step must be performed within 5 seconds if you desire to also use a Remote Keyless Entry transmitter to recall memory positions.

9. Press and release the "Lock" button on one of the transmitters.
10. Insert the ignition key and turn the ignition switch to the ON position.
11. Select "Remote Linked to Memory" in the Electronic Vehicle Information Center (EVIC) and enter "Yes" or select "Use Factory Settings" from the EVIC and enter "Yes". Refer to "Customer Programmable Features" in the Electronic Vehicle Information Center (EVIC) section for more information.
12. Repeat the above steps to set the next memory position using the other numbered memory button or to link another Remote Keyless Entry transmitter to memory.

Memory Position Recall

NOTE: The vehicle must be in Park to recall memory positions. If a recall is attempted when the vehicle is not in Park, a message will be displayed in the Electronic Vehicle Information Center (EVIC).

To recall the memory settings for driver one, press memory button number 1 on the driver's door or the "Unlock" button on the Remote Keyless Entry transmitter linked to memory position 1.

To recall the memory setting for driver two, press memory button number 2 on the driver's door or the "Unlock" button on the Remote Keyless Entry transmitter linked to memory position 2.

A recall can be cancelled by pressing any of the memory buttons on the drivers door during a recall (S, 1, or 2). When a recall is cancelled, the driver's seat, driver's

mirror, and the pedals stop moving. A delay of one second will occur before another recall can be selected.

To Disable A Transmitter Linked to Memory

1. Turn the ignition switch to the OFF position and remove the key.
2. Press and release memory button number 1. The system will recall any memory settings stored in position 1. Wait for the system to complete the memory recall before continuing to step 3.
3. Press and release the memory SET (S) button located on the driver's door.

4. Within 5 seconds, press and release memory button 1 on the driver's door.

5. Within 5 seconds, press and release the "Unlock" button on the Remote Keyless Entry transmitter.

To disable another transmitter linked to either memory position, repeat steps 1-5 for each transmitter.

NOTE: Once programmed, all transmitters linked to memory can be easily enabled or disabled at one time. Refer to Remote Linked to Memory under "Customer Programmable Features" in the Electronic Vehicle Information Center (EVIC) for more information.

TO OPEN AND CLOSE THE HOOD

To open the hood, pull the release lever inside your vehicle located below the instrument panel and in front of the driver's door.

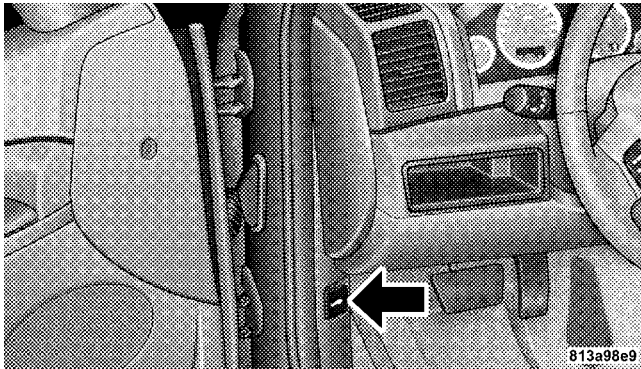

Hood Release Lever

Then reach under the hood and pull upward on the safety latch and lift the hood. To prevent possible damage, do not slam the hood to close it. Use a firm downward push at the center of the hood to ensure that both latches engage.

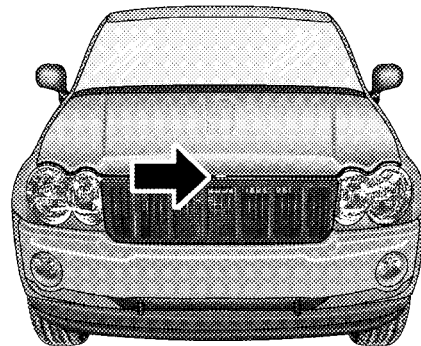

8144e467

Underhood Safety Latch

WARNING!

If the hood is not fully latched, it could fly up when the vehicle is moving and block your forward vision. Be sure all hood latches are fully latched before driving.

LIGHTS**Interior Lighting**

The interior lighting consists of courtesy lights mounted below the instrument panel, an overhead console light assembly which contains both driver and passenger reading lights, reading lights located above the rear doors, and a rear cargo light. Opening a door or turning the center of the multi-function control lever to the extreme up position will activate all interior courtesy lights.

Front Map/Reading Lights

These lights are mounted in the overhead console. Each light can be turned on by pressing the recessed area of the lens. To turn these lights off, press the recessed area of the lens a second time. There are also reading lights located above the rear doors. Each light can be turned on by pressing the front recessed area of the lens. To turn these lights off, press the recessed area of the lens a second time.

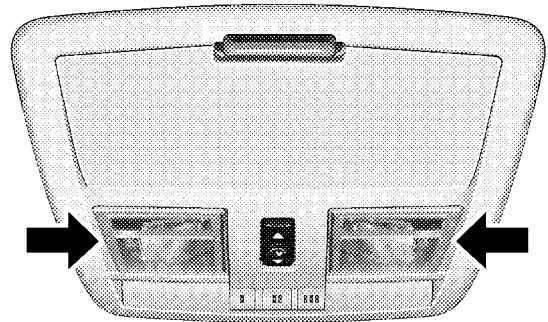
3

Front Map/Reading Lights

813ac107

Multi-Function Control Lever

The multi-function control lever controls the operation of the headlights, turn signals, headlight beam selection, instrument panel light dimming, passing light, interior courtesy/dome lights, and optional fog lights.

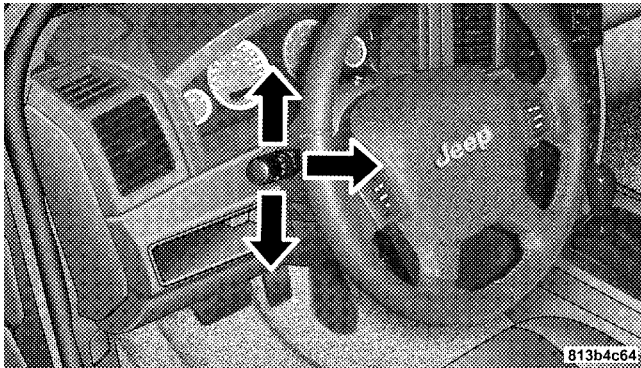

Multi-Function Control Lever

Battery Saver Feature—Exterior/Interior Lights

If the multi-function control lever is left in the interior light position, parking light position, or the headlight position when the ignition switch is moved to the OFF position, the battery saver feature will automatically turn off the exterior and interior lights after eight minutes. Normal operation will resume when the ignition is turned ON or when the headlight switch is turned to another position.

Headlights and Parking Lights

Turn the end of the multi-function control lever to the first detent for parking light operation. Turn to the second detent for headlight operation. Turn to the third detent for "Auto" headlight operation (if equipped).

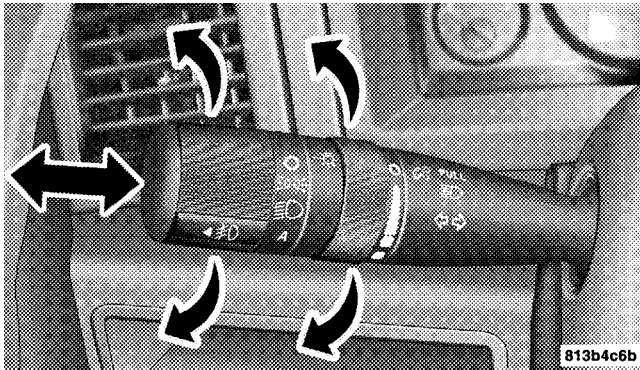

Headlight Switch

Automatic Headlight System — If Equipped

Turn the end of the multi-function control lever to the third detent to activate the automatic headlight system.

This system performs two functions. With the engine running and the multi-function control lever in the A (Auto) position, the headlights will turn on and off based on the surrounding light levels.

Headlights On Automatically With Wipers

If your vehicle is equipped with Automatic Headlights it also has this customer programmable feature. When your headlights are in the automatic mode, and the engine is running, they will automatically turn on when the wiper system is on.

If your vehicle is equipped with a "Rain Sensitive Wiper System," and it is activated, the headlights will automatically turn on after the wipers complete five wipe cycles within approximately 1 minute, and they will turn off

approximately four minutes after the wipers completely stop. Refer to “Windshield Wipers and Washers” in this section for more information

NOTE: When your headlights come on during the daytime, the instrument panel lights will automatically dim to the lower nighttime intensity. Refer to “Instrument Panel and Interior Lights” below for setting the instrument panel lights to full daytime intensity.

SmartBeams — If Equipped

The SmartBeam system provides increased forward lighting at night by automating high beam control through the use of a digital camera mounted on the inside rearview mirror. This camera detects vehicle specific light and automatically switches from high beams to low beams until the approaching vehicle is out of view.

To Activate

1. Select “Enable Auto HI Beams.” Refer to “EVIC — Customer Programmable Features” in Section 4 of this manual.
2. Turn the end of the multi-function control lever to the A (Auto) headlight position.

NOTE: This system will not activate until the vehicle is at or above 20 mph (32 km/h).

To Deactivate

1. Pull back on the multi-function control lever to manually deactivate the system (normal operation of high beams).
2. Pull back on the multi-function control lever once again to re-activate the system.

NOTE: Broken, muddy, or obstructed headlights and taillights of vehicles in the field of view will cause headlights to remain on longer (closer to the vehicle). Also, dirt, film, and other obstructions on the windshield or camera lens will cause the system to function improperly.

Instrument Panel and Interior Lights

When the multi-function control lever is in the parklight, headlight, or A (Auto) position (if equipped), rotating the center portion of the lever up and down will increase and decrease the brightness (dimmer control) of the instrument panel lights. Full daytime brightness on all electronic displays (odometer, overhead console, radio, and Automatic Climate Control (if equipped)) is obtained by rotating the center portion of the control to the first detent above the dimmer range. Rotating the control to the second detent above the dimmer range turns the interior lights on. Rotating the control to the "Off" (extreme bottom) position disables all the interior lights,

even when the doors and liftgate are open. While in the "Off" position the instrument panel lighting is at the lowest light level and may not be suitable for night driving.

Daytime Running Lights — Canada Only

The headlights come on at a low intensity level whenever the engine is running. The lights remain on until the ignition switch is turned OFF or the parking brake is engaged. The headlight switch must be used for normal night time driving.

Lights-On Reminder

If the headlights or parking lights are on after the ignition is turned OFF, a chime will sound when the driver's door is opened.

Fog Lights — If Equipped

#D The fog light switch is located in the multi-function control lever. To activate the fog lights, turn on the park/turn lights, low beam headlights, or “Auto” headlights and pull out the end of the multi-function control lever. A light in the instrument cluster shows when the fog lights are on.

NOTE: Turning on the high beam headlights turns off the fog lights.

A front fog light is a lighting device providing illumination forward of the vehicle under conditions of fog, rain, snow, or dust. Principally, the front fog light supplements the lower beam of a standard headlight system.

NOTE: Proper aim and adjustments of the front fog lights should be made to prevent excessive glare for other drivers.

Turn Signals

Move the multi-function control lever up or down and the arrows on each side of the instrument cluster will flash to show proper operation of the front and rear turn signal lights. You can signal a lane change by moving the lever partially up or down.

High Beam Switch

Pull the multi-function control lever towards you to switch the headlights to “High” beam. The “High Beam Indicator Light” on the instrument cluster will illuminate. Pull the multi-function control lever a second time to switch the headlights to “Low” beam.

Passing Light

You can signal another vehicle with your headlights by lightly pulling the multi-function control lever toward the steering wheel. This will cause the headlights to turn on at high beam and remain on until the lever is released.

Headlight Time Delay

There is also a feature that delays turning off the vehicle lights for 30, 60, or 90 seconds after the ignition switch is turned OFF. To activate the headlight delay, the multi-function control lever must be rotated to the "Off" position after the ignition switch is turned OFF. Only the headlights will illuminate during this time. Refer to "EVIC- Customer Programmable Features" in Section 4 to turn this feature "On/Off" or set the time interval.

WINDSHIELD WIPERS AND WASHERS

The front and rear wipers and washers are operated by a switch in the right side control lever. Turn the end of the control lever to select "Lo," "Hi," or one of the five speed sensitive intermittent windshield wiper speeds. Refer to "Speed Sensitive Intermittent Wiper System" in this section. For information on the rear wiper and washer refer to "Rear Window Features" in this section.

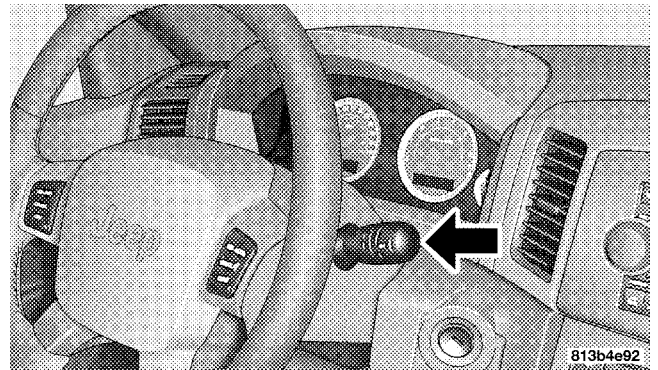

Windshield Wiper/Washer Switch

NOTE: Always remove any build-up of snow that prevents the windshield wiper blades from returning to the OFF position. If the windshield wiper switch is turned off and the blades cannot return to the OFF position, damage to the wiper motor may occur.

To use the washer, pull the lever toward you and hold while spray is desired. If the lever is pulled while in the delay range, the wiper will operate for several seconds after the lever is released, and then resume the intermittent interval previously selected.

If the lever is pulled while in the OFF position, the wipers will operate for several wipe cycles, then turn off.

WARNING!

Sudden loss of visibility through the windshield could lead to an accident. You might not see other vehicles or other obstacles. To avoid sudden icing of the windshield during freezing weather, warm the windshield with the defroster before and during windshield washer use.

Mist

Use this feature when weather conditions make occasional usage of the wipers necessary. Pull down and release the control lever for a single wiping cycle.

Speed Sensitive Intermittent Wiper System

Use one of the five intermittent wiper speeds when weather conditions make a single wiping cycle, with a variable pause between cycles, desirable. Turn the end of the lever to one of the five delay positions for the desired delay interval. The delay can be regulated from a maximum of approximately 18 seconds between cycles, to a cycle every 1/2 second.

NOTE: The wiper delay times depend on vehicle speed. If the vehicle is moving less than 10 mph (16 km/h), delay times will be doubled.

Rain Sensing Wipers—If Equipped

This feature senses moisture on the windshield and automatically activates the wipers for the driver. The feature is especially useful for road splash or overspray from the windshield washers of the vehicle ahead. Rotate the end of the multi-function lever to one of six settings to activate this feature.

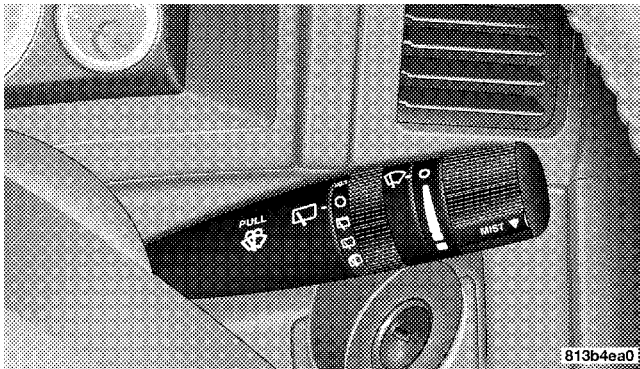

Rain Sensitive Wiper Switch

The sensitivity of the system can be adjusted with the multi-function lever. Wiper delay position 1 is the least sensitive, and wiper delay position 5 is the most sensitive. Setting 3 should be used for normal rain conditions. Settings 1 and 2 can be used if the driver desires less wiper sensitivity. Settings 4 and 5 can be used if the driver desires more sensitivity. Place the wiper switch in the OFF position when not using the system.

NOTE:

- The rain sensing feature will not operate when the wiper switch is in the LOW or HIGH speed position.
- The rain sensing feature may not function properly when ice, or dried salt water is present on the windshield.
- Use of Rain-X® or products containing wax or silicone may reduce rain sensor performance.

- The rain sensing system will not operate under the following conditions: when the engine is running and the gear selector is in the PARK position, or when the vehicle is started in below freezing temperatures. This is done to protect the wiper blades from damage. Place the gear selector in the DRIVE position to allow the rain sensing feature to operate.
- A customer programmable feature in the Electronic Vehicle Information Center (EVIC) allows the Rain Sense feature to be turned off. Refer to “Electronic Vehicle Information Center (EVIC)” in Section 4 of this manual.

TILT STEERING COLUMN

To tilt the column, push down on the lever below the turn signal control and move the wheel up or down, as desired. Pull the lever back towards you and firmly push the lever until it is above the lower surface of the shroud to lock the column in place.

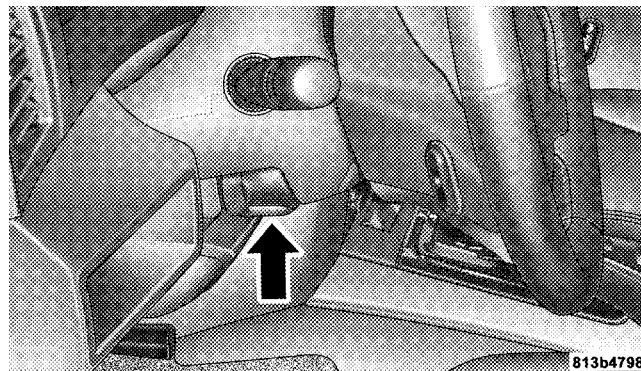

Tilt Steering Column

WARNING!

Tilting the steering wheel column while the vehicle is moving is dangerous. Without a stable steering column, you could lose control of the vehicle and have an accident. Adjust the tilting mechanism only while the vehicle is stopped. Be sure it is locked before driving.

TRACTION CONTROL — IF EQUIPPED

The Traction Control System monitors the amount of wheel spin in each of the driven wheels. If wheel spin is detected, the pressure to the brake system of the slipping wheel(s) is modulated to provide enhanced acceleration. The system operates at speeds typically encountered in city traffic driving. 4WD models also include unique logic in 4 HI or 4 LO (if equipped) to enhance off-road capabilities.

The “Traction Control Indicator Light,” located in the instrument cluster, will flash when the Traction Control System is active.

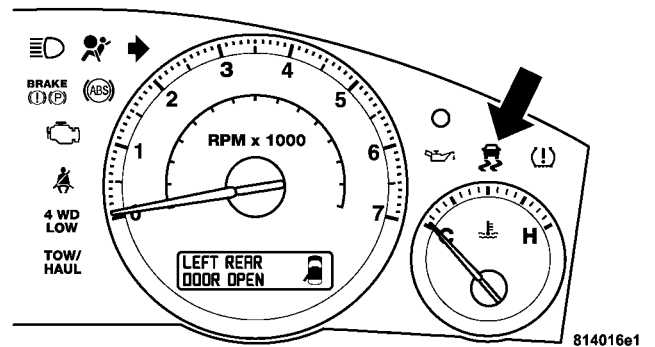

Traction Control Indicator Light

To turn the system OFF, press the switch, located below the climate controls in the center stack, until the “Traction Control Indicator Light” turns on and stays on. Also, a

“TRACTION SYS DISABLED” message will be displayed in the Electronic Vehicle Information Center (EVIC). Refer to Section 4 of this manual.

To turn the system back ON, press the switch a second time, until the “Traction Control Indicator Light” turns off.

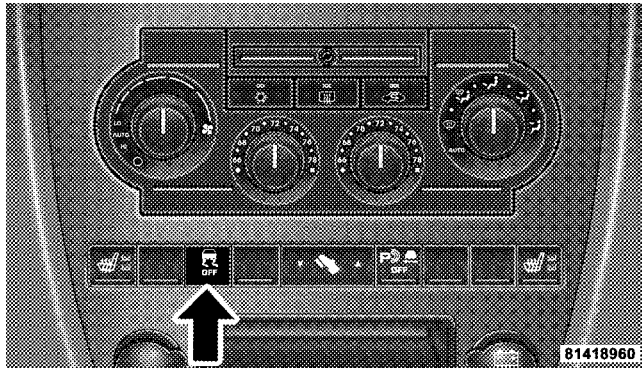

Traction Control Switch

When the Traction Control System has been turned off using the switch, a feature of the system remains active. This feature functions similar to a limited slip differential and controls the wheel spin across an axle. If one wheel on an axle is spinning faster than the other, the system will apply the brake of the spinning wheel and allow more engine torque to be applied to the wheel that is not spinning.

NOTE:

- The “Traction Control Indicator Light” comes on momentarily each time the ignition switch is turned ON. This will occur even if you used the switch to turn the system OFF.
- Each time the ignition is turned ON, the Traction Control System will be ON even if it was turned OFF previously.
- The Traction Control System will make buzzing or clicking sounds when it is active.

There are two Electronic Vehicle Information Center (EVIC) messages associated with the Traction Control System. Refer to Section 4 of this manual.

Traction Sys Disabled

This message will be displayed if the Traction Control System has been turned off using the switch, or if there is a temporary condition that will result in partial or no Traction Control System function. The “Traction Control Indicator Light” will be on when the system is disabled or only partial function is allowed. The “TRACTION SYS DISABLED” message and the “Traction Control Indicator Light” being illuminated without the switch being depressed is not an indication that service of the electronic brake system is required.

Service Elec Brake System

This message will be displayed if a condition exists that may require servicing the electronic brake system. When this message is displayed and the “Traction Control Indicator Light” is on, there is a malfunction of the Traction Control System. If the “SERVICE ELEC BRAKE SYSTEM” message continues to be displayed after several ignition cycles and the vehicle has been driven several miles at speeds greater than 30 mph (48 km/h), see your authorized dealer for service.

ELECTRONIC STABILITY PROGRAM (ESP)— IF EQUIPPED**WARNING!**

ESP (Electronic Stability Program) cannot prevent the natural laws of physics from acting on the vehicle, nor can it increase the traction afforded. The ESP cannot prevent accidents, including those resulting from excessive speed in turns, or hydroplaning. Only a safe, attentive, and skillful driver can prevent accidents. The capabilities of an ESP-equipped vehicle must never be exploited in a reckless or dangerous manner which could jeopardize the user's safety or the safety of others.

ESP (Electronic Stability Program) enhances directional control and reduces driving wheel spin of the vehicle under various driving conditions.

ESP corrects for over/understeering of the vehicle by applying brakes to the appropriate wheel. Engine torque is also limited. The "ESP Indicator Light," located in the instrument cluster, starts to flash as soon as the tires lose traction and the ESP system becomes active.

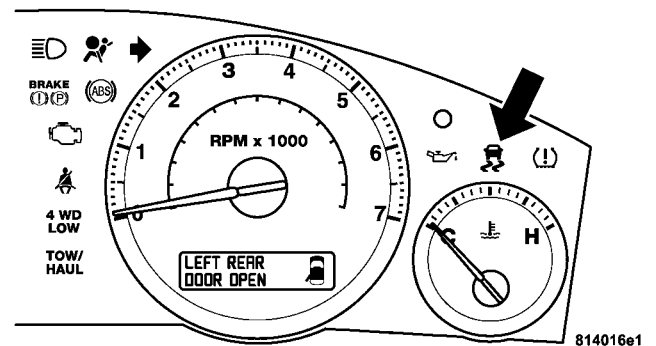

ESP Indicator Light

To turn the ESP system OFF, press the switch, located below the climate controls in the center stack, until the "ESP Indicator Light" in the instrument cluster turns on and the message "ESP SYSTEM DISABLED" appears in the Electronic Vehicle Information Center (EVIC). Refer to Section 4 of this manual. To turn the system back ON, press the switch a second time until the "ESP Indicator Light" turns off. ESP is always available during braking (in 4WD Hi) even if it has been switched off.

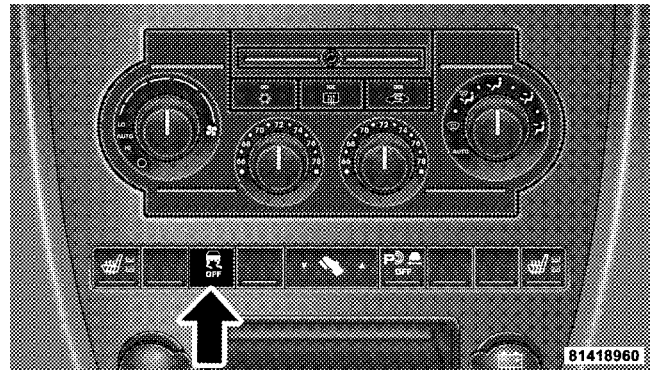

ESP Control Switch

When the ESP system has been switched off, a feature of the system remains active. This feature functions similar to a limited slip differential and controls the wheel spin across an axle. If one wheel on an axle is spinning faster

than the other, the system will apply the brake of the spinning wheel and allow more engine torque to be applied to the wheel that is not spinning.

To improve the vehicle's traction when driving with snow chains, or starting off in deep snow, sand or gravel, it may be desirable to switch off the ESP by pressing the ESP switch.

With the ESP switched off, the engine torque reduction and stability features are cancelled. Therefore, the enhanced vehicle stability offered by ESP is unavailable.

If the "ESP Indicator Light" begins to flash during acceleration, ease up on the accelerator and apply as little throttle as possible. Be sure to adapt your speed and driving to the prevailing road conditions. When the "ESP Indicator Light" is illuminated continuously, the ESP is switched off. To return to the enhanced vehicle stability offered by ESP, press the ESP switch (the "ESP Indicator

Light" in the instrument cluster goes out). Avoid spinning one drive wheel. This may cause serious damage to the drive train.

NOTE:

- The "ESP Indicator Light" comes on momentarily each time the ignition switch is turned ON.
- Each time the ignition is turned ON, the ESP System will be ON even if it was turned off previously.
- The ESP Control System will make buzzing or clicking sounds when it is active.

There are two Electronic Vehicle Information Center (EVIC) messages associated with the Electronic Stability Control System. Refer to Section 4 of this manual.

ESP System Disabled

This message will be displayed if the ESP System has been turned off using the switch, or if there is a temporary condition that will result in partial or no ESP

function. The “ESP Indicator Light” will be on when the system is disabled or only partial function is allowed. The “ESP SYSTEM DISABLED” message and the “ESP Indicator Light” being illuminated without the switch being depressed is not an indication that service of the electronic brake system is required.

Also, the “ESP SYSTEM DISABLED” message will be present when the vehicle is shifted into 4WD LOW.

Service Elec Brake System

This message will be displayed if a condition exists that may require servicing the electronic brake system. When this message is displayed and the “ESP Indicator Light” is on, there is a malfunction of the ESP System. If the “SERVICE ELEC BRAKE SYSTEM” message continues to be displayed after several ignition cycles and the vehicle has been driven several miles at speeds greater than 30 mph (48 km/h), see your authorized dealer for service.

CAUTION!

The manufacturer recommends towing with all four wheels off the ground. Acceptable methods are to tow the vehicle on a flatbed or with one end of the vehicle raised and the other end on a towing dolly.

3

REAR PARK ASSIST SYSTEM— IF EQUIPPED

The Rear Park Assist System provides visual and audible indications of the distance between the rear fascia and the detected obstacle when backing up. Refer to the Warning Section and Note Section for limitations of this system and recommendations.

The Rear Park Assist System will remember the last system state (enabled or disabled) from the last ignition cycle when the ignition is changed to the RUN/ON position.

The Rear Park Assist System can be active only when the shifter is in R (Reverse). If the Rear Park Assist System is enabled at this shifter position, the system will be active until the vehicle speed is increased to approximately 11.2 miles/hr (18 km/h) or above. The system will be active again if the vehicle speed is decreased to speeds less than approximately 9.94 miles/hr (16 km/h).

Rear Park Assist Sensors

The four Rear Park Assist Sensors, located in the rear fascia, monitor the area behind the vehicle that is within the sensors' field of view. The monitored area seems oval in shape.

The sensors can detect obstacles from approximately 11.8 inches (30 cm) up to 59 inches (150 cm) from the rear fascia in the horizontal direction, depending on the location and orientation of the obstacle and the type of obstacle.

Rear Park Assist Warning Display

The Rear Park Assist Warning Display, located in the headliner near the flipper glass, provides both visual and audible warnings to indicate the distance between the rear fascia and the detected obstacle.

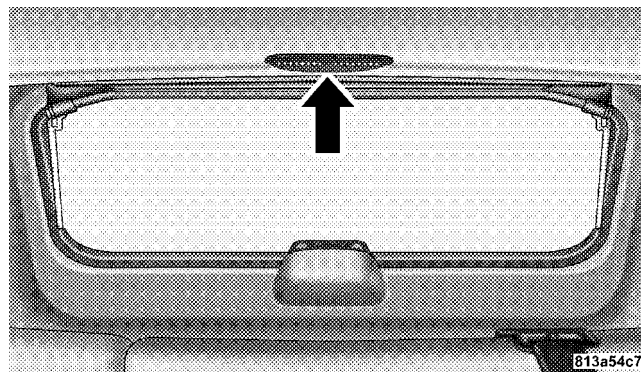

Rear Park Assist Display

When the ignition is changed to the RUN/ON position, the warning display will turn ON all of its LEDs for about 1 sec.

Each side of the warning display has 6 yellow and 2 red LEDs. The vehicle is close to the obstacle when the red LED is ON.

When the obstacle is detected at a distance of about 59 inches (150 cm) from the rear fascia, the outermost LEDs of the warning display will be ON with increased brightness. As the distance of the detected obstacle to the rear fascia decreases, more LEDs are illuminated. The warning display will not actuate a tone when only yellow LEDs are ON.

When the warning display has the first 7 LEDs ON, including 1 red LED, the warning display will actuate an intermittent tone for about 3 sec. The radio will be muted while the tone is actuated.

When the detected obstacle is about 11.8 inches (30 cm) from the rear fascia, the warning display will actuate a continuous tone for about 3 sec and it will turn ON all 8 LEDs, including both RED LEDs, on the corresponding side of the display. The radio will be muted while the tone is actuated.

When the obstacle is less than 11.8 inches (30 cm) from the rear fascia, the warning display will either have all 8 LEDs ON (obstacle detected) or it will have only the outermost LEDs ON with decreased brightness (obstacle not detected), depending on the location of the obstacle.

Enable/Disable the Rear Park Assist System

The Rear Park Assist System can be enabled and disabled with a switch located in the switch bank of the instrument panel.

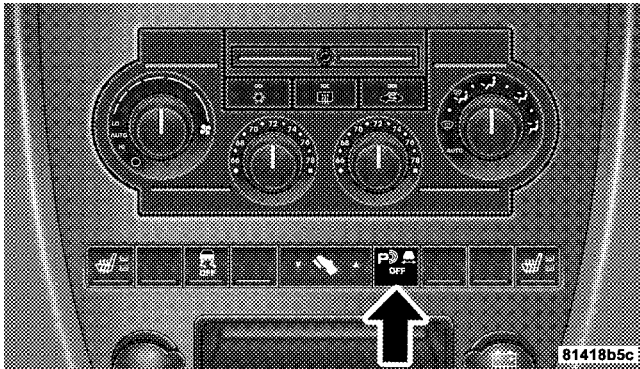

Rear Park Assist Switch

When the switch is pressed to disable the system, the instrument cluster will display the "PARK ASSIST DISABLED" message. Refer to Electronic Vehicle Information Center (EVIC) in Section 4 of this manual. When the shifter is changed to R (Reverse) and the system is disabled, the instrument cluster will actuate a single chime, once per ignition cycle, and it will display the message.

The Rear Park Assist Switch LED will be ON when the Rear Park Assist System is disabled or defective. The Rear Park Assist Switch LED will be OFF when the system is enabled.

Service the Rear Park Assist System

When the Rear Park Assist System is defective, the instrument cluster will actuate a single chime, once per ignition cycle, and it will display the "SERVICE PARK ASSIST SYSTEM" message. Refer to Electronic Vehicle Information Center (EVIC) in Section 4 of this manual.

Cleaning the Rear Park Assist System

Clean the Rear Park Assist Sensors with water, car wash soap and a soft cloth. Do not use rough or hard cloths. Do not scratch or poke the sensors. Otherwise, you could damage the sensors.

CAUTION!

- The Rear Park Assist System is only a parking aid and it is unable to recognize every obstacle, including small obstacles. Parking curbs might be temporarily detected or not detected at all. Obstacles located above or below the sensors will not be detected when they are in close proximity.
- The vehicle must be driven slowly when using the Rear Park Assist System to be able to stop in time when the obstacle is detected. It is recommended that the driver looks over his/her shoulder when using the Rear Park Assist System.

WARNING!

- Drivers must be careful when backing up even when using the Rear Park Assist System. Always check carefully behind your vehicle, look behind you, and be sure to check for pedestrians, animals, other vehicles, obstructions, and blind spots before backing up. You are responsible for safety and must continue to pay attention to your surroundings. Failure to do so can result in serious injury or death.
- Before using the Rear Park Assist System, it is strongly recommended that the ball mount and hitch ball assembly is disconnected from the vehicle when the vehicle is not used for towing. Failure to do so can result in injury or damage to vehicles or obstacles because the hitch ball will be much closer to the obstacle than the rear fascia when the warning display turns the red LEDs ON. Also, the sensors could detect the ball mount and hitch ball assembly, depending on its size and shape, giving a false indication that an obstacle is behind the vehicle.

NOTE: Clean all four Rear Park Assist Sensors regularly, taking care not to scratch or damage them. The sensors must not be covered with ice, snow, slush, mud, dirt or debris. Failure to do so can result in the system not working properly. The system might not detect an obstacle behind the fascia or it could provide a false indication that an obstacle is behind the fascia.

Assure objects are not within 11.8 inches (30 cm) from the rear fascia while driving the vehicle. Failure to do so can result in the system misinterpreting a close object as a sensor problem, causing the "SERVICE PARK ASSIST SYSTEM" message to be displayed in the instrument cluster.

Ultrasonic noise from airbrakes of nearby trucks, air powered jackhammers and air powered shop tools, to name a few, will cause the Rear Park Assist System to be disabled until the ultrasonic noise is no longer present.

ADJUSTABLE PEDALS — IF EQUIPPED

This feature allows both the brake and accelerator pedals to move toward the driver to provide improved position with the steering wheel. The adjustable pedal system is designed to allow a greater range of driver comfort for steering wheel tilt and seat position. The position of the brake and accelerator pedals can be adjusted without compromising safety or comfort in actuating the pedals.

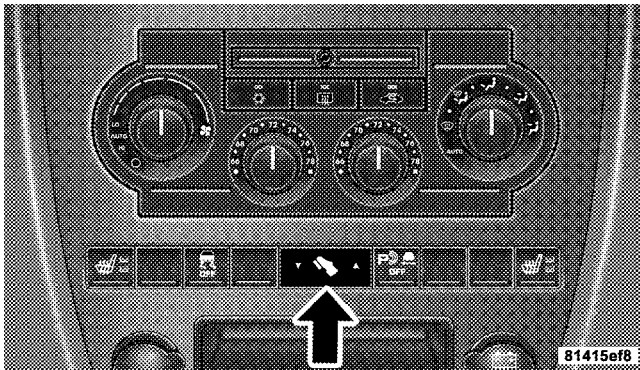

Adjustable Pedal Switch

Press the left side of the button to move the pedals rearward (toward the driver).

Press the right side of the button to move the pedals forward (away from the driver).

- The pedals can be adjusted with the ignition OFF.

- The pedals can be adjusted while driving.
- The pedals **cannot** be adjusted when the vehicle is in R (Reverse) or when the Speed Control is ON. A message will be displayed in the Electronic Vehicle Information Center (EVIC) if the pedals are attempted to be adjusted when the system is locked out (“Adjustable Pedal Disabled — Cruise Control Engaged” or “Adjustable Pedal Disabled — Vehicle In Reverse”). Refer to Electronic Vehicle Information Center (EVIC) in Section 4 for more information.

CAUTION!

Do not place any article under the adjustable pedal’s or impede its ability to move as it may cause damage to the pedal controls. Pedal travel may become limited if movement is stopped by an obstruction in the adjustable pedal’s path.

ELECTRONIC SPEED CONTROL

When engaged, this device takes over accelerator operations at speeds greater than 25 mph (40 km/h) for 5.7L engines, and 30 mph (48 km/h) for 3.7L/4.7L engines. The controls are mounted on the steering wheel and consist of ON-OFF, SET, RES-ACCEL, CANCEL, and DECEL controls.

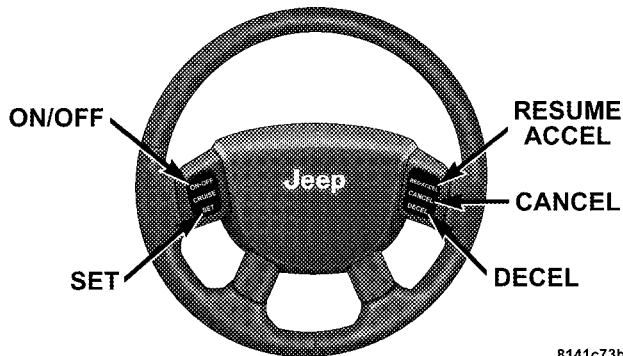

8141c73b

To Activate

Press the ON-OFF button to turn the system ON. To turn the system OFF, press the ON-OFF button again. The system should be turned OFF when not in use. The CRUISE indicator light in the instrument cluster will illuminate when the system is ON.

To Set at a Desired Speed

When the vehicle has reached the desired speed, press and release the SET button. Release the accelerator and the vehicle will operate at the selected speed.

To Deactivate

A soft tap on the brake pedal, normal braking, or pressing the CANCEL button will deactivate the Speed Control without erasing the memory. Pressing the ON-OFF to turn the system OFF or turning off the ignition erases the memory.

To Resume Speed

To resume a previously set speed, press and release the RES-ACCEL button. Resume can be used at any speed above 25 mph (40 km/h) for 5.7L engines, and 30 mph (48 km/h) for 3.7L/4.7L engines.

To Vary the Speed Setting

When the Speed Control is ON, speed can be increased by pressing and holding the RES-ACCEL button. When the button is released, a new set speed will be established.

Tapping the RES-ACCEL button once will result in a 2 mph (3 km/h) (3.7L/4.7L Models) or a 1 mph (2 km/h) (5.7L Models) speed increase. Each time the button is tapped, speed increases, so tapping the button three times will increase speed by 6 mph (10 km/h) (3.7L/4.7L Models) or 3 mph (5 km/h) (5.7L Models), etc.

To decrease speed while Speed Control is ON and SET, press and hold the DECEL button. Release the button when the desired speed is reached, and the new speed will be set.

To Accelerate for Passing

Depress the accelerator as you would normally. When the pedal is released, the vehicle will return to the set speed.

NOTE: When driving uphill, at elevations above 2,000 feet (610 meters), or when the vehicle is heavily loaded (especially when towing) the vehicle may slow below the SET speed. If the vehicle speed drops below 25 mph (40 km/h) for 5.7L models, or 30 mph (48 km/h) for 3.7L/4.7L models, the Speed Control will automatically disengage. If this happens, you can push down on the accelerator pedal to maintain the desired speed.

Vehicles may exhibit several 4-3 downshifts under the above conditions. To reduce the frequency of the downshifts and to improve vehicle performance, it is advisable

to lock out overdrive. Press the TOW/HAUL switch on the lower center switch bank (below the Heating/Air Conditioning controls).

WARNING!

Leaving the Speed Control ON when not in use is dangerous. You could accidentally set the system or cause it to go faster than you want. You could lose control and have an accident. Always leave the system OFF when you aren't using it.

Driving Up or Down Hills

When going up or down hills, it is possible for your vehicle to lose or gain speed, even though the Speed Control is engaged. The automatic transmission may also downshift to a lower gear, to maintain speed going up or down hills. If going down a hill steep enough to cause the

vehicle to gain speed, press the brake pedal, which will disengage the Speed Control and help slow your vehicle.

WARNING!

To help keep your vehicle under control, do not use Speed Control under these conditions:

- When it is not possible to keep your vehicle at a set speed.
- On slippery roads, such as on snow or ice.
- In heavy or varying traffic volume, in traffic that varies in speed, or on winding roads.
- Be sure to turn the Speed Control switch to the OFF position when not in use to avoid accidental engagement.

OVERHEAD CONSOLE — IF EQUIPPED

The overhead console contains courtesy/reading lights, an optional universal garage door opener (HomeLink®), storage for sunglasses, and optional power sunroof switches.

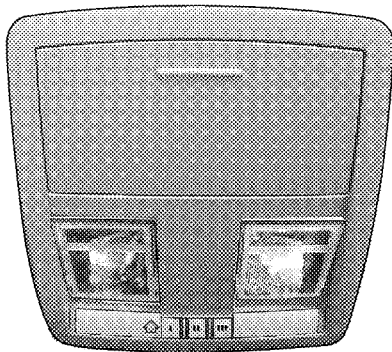

Overhead Console

8125e191

Courtesy/Reading Lights

At the forward end of the console are two courtesy/reading lights.

Press the lens to turn these lights on. Press a second time to turn the lights off.

The lights also turn on when a front door or rear door is opened. The lights will also turn on when the unlock button on the remote keyless entry transmitter is pressed.

Sunglasses Storage

At the rear of the console a compartment is provided for the storage of a pair of sunglasses.

The storage compartment access is a "push/push" design. Push the finger depression on the overhead console to open. Push the finger depression to close.

GARAGE DOOR OPENER — IF EQUIPPED

The HomeLink® Universal Transceiver replaces up to three remote controls (hand held transmitters) that operate devices such as garage door openers, motorized gates, or home lighting. It triggers these devices at the push of a button. The Universal Transceiver operates off your vehicle’s battery and charging system; no batteries are needed.

NOTE: The HomeLink® Universal Transceiver is disabled when the Vehicle Theft Alarm is active.

For additional information on HomeLink®, call 1-800-355-3515, or on the internet at www.homelink.com.

WARNING!

A moving garage door can cause injury to people and pets in the path of the door. People or pets could be seriously or fatally injured. Only use this transceiver with a garage door opener that has a “stop and reverse” feature as required by federal safety standards. This includes most garage door opener models manufactured after 1982. Do not use a garage door opener without these safety features it could cause injury or death. Call toll-free 1-800-355-3515 or, on the Internet at www.homelink.com for safety information or assistance.

Programming HomeLink

NOTE: When programming a garage door opener, it is advised to park outside the garage. It is also recommended that a new battery be placed in the hand-held transmitter of the device being programmed to HomeLink for quicker training and accurate transmission of the radio-frequency signal.

The Electronic Vehicle Information Center (EVIC) features a driver-interactive display which includes HomeLink system messages. The EVIC is located on the bottom of the tachometer.

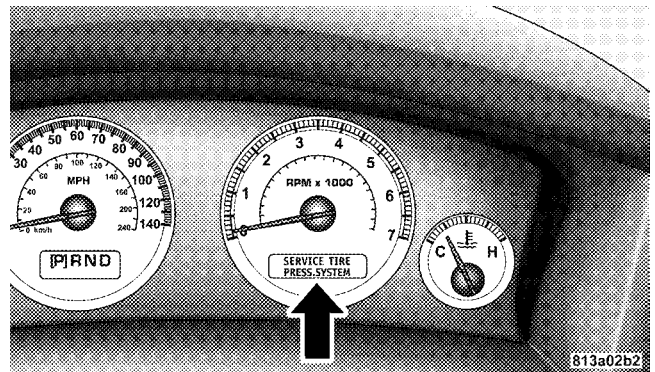

Electronic Vehicle Information Center

1. Press and hold the two outer HomeLink buttons, and release only when the EVIC display shows "CHANNELS CLEARED" (after 20 seconds). **Do not** hold the buttons for longer than 30 seconds and **do not** repeat step one to program a second and/or third hand-held transmitter to the remaining two HomeLink buttons.

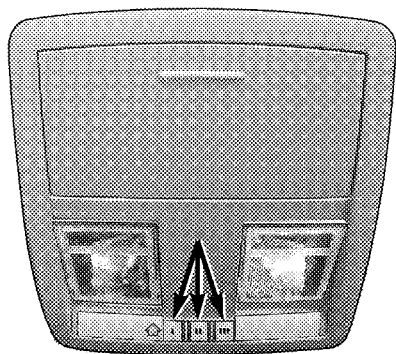

HomeLink Buttons

8125e19b

WARNING!

Vehicle exhaust contains carbon monoxide, a dangerous gas. Do not run the vehicle's exhaust while training the transceiver. Exhaust gas can cause serious injury or death.

WARNING!

Your motorized door or gate will open and close while you are training the Universal Transceiver. Do not train the transceiver if people or pets are in the path of the door or gate. A moving door or gate can cause serious injury or death to people and pets or damage to objects.

2. Position the end of your hand-held transmitter 1-3 inches (3-8 cm) away from the HomeLink buttons.

3. Simultaneously press and hold both the HomeLink button that you want to train and the hand-held transmitter buttons. **Do not release the buttons until step 4 has been completed.**

NOTE: Some gate operators and garage door openers may require you to replace this Programming Step 3 with procedures noted in the "Gate Operator/Canadian Programming" section.

4. The EVIC display will show "CHANNEL X TRAINING" (where X is Channel 1, 2, or 3). Release both buttons after the EVIC display shows "CHANNEL X TRAINED."

NOTE: If the EVIC display shows "DID NOT TRAIN" repeat steps 2-4.

5. Press and hold the just trained HomeLink button and observe the EVIC display. If the EVIC display shows "CHANNEL X TRANSMIT" (where X is Channel 1, 2, or

3), programming is complete and your device should activate when the HomeLink button is pressed and released.

NOTE: To program the remaining two HomeLink buttons, begin with "Programming" **step two. Do not repeat step one.**

NOTE: If your hand-held transmitter appears to program the universal transceiver, but your garage door does not operate using the transmitter and your garage door opener was manufactured after 1995, your garage door opener may have a multiple security code system (rolling code system). Please proceed to steps 6-8 to complete the programming of a rolling code equipped device (most common garage door openers require this step).

6. At the garage door opener receiver (motor-head unit) in the garage, locate the "learn" or "smart" button. This can usually be found where the hanging antenna wire is attached to the motor-head unit.

7. Firmly press and release the "learn" or "smart" button. (The name and color of the button may vary by manufacturer.)

NOTE: There are 30 seconds in which to initiate step eight.

8. Return to the vehicle and firmly **press, hold for two seconds and release** the programmed HomeLink button. Repeat the "**press/hold/release**" sequence a second time, and, depending on the brand of the garage door opener (or other rolling code equipped device), repeat this sequence a third time to complete the programming.

HomeLink should now activate your rolling code equipped device.

NOTE: To program the remaining two HomeLink buttons, begin with "Programming" **step two. Do not repeat step one.** For questions or comments, please contact HomeLink at www.homelink.com or 1-800-355-3515.

Canadian Programming/Gate Programming

Canadian radio-frequency laws require transmitter signals to "time-out" (or quit) after several seconds of transmission which may not be long enough for HomeLink to pick up the signal during programming. Similar to this Canadian law, some U.S. gate operators are designed to "time-out" in the same manner.

If you live in Canada or you are having difficulties programming a gate operator by using the "Programming" procedures (regardless of where you live), **replace "Programming HomeLink" step 3** with the following:

NOTE: If programming a garage door opener or gate operator, it is advised to unplug the device during the "cycling" process to prevent possible overheating.

3. Continue to press and hold the HomeLink button while you **press and release every two seconds** ("cycle") your hand-held transmitter until the frequency signal has successfully been accepted by HomeLink. The EVIC display will show "CHANNEL X TRAINED" (where X is Channel 1, 2, or 3). Proceed with "Programming" step four to complete.

Using HomeLink

To operate, simply press and release the programmed HomeLink button. Activation will now occur for the trained device (i.e. garage door opener, gate operator, security system, entry door lock, home/office lighting, etc.). For convenience, the hand-held transmitter of the device may also be used at any time. In the event that there are still programming difficulties or questions, contact HomeLink at: www.homelink.com or 1-800-355-3515.

Erasing HomeLink Buttons

To erase programming from the three buttons (individual buttons cannot be erased but can be "reprogrammed" - note below), follow the step noted:

- Press and hold the two outer HomeLink buttons and release only when the EVIC display shows "CHANNELS CLEARED" (after 20 seconds). Release both buttons. Do not hold for longer than 30 seconds. HomeLink is now in the train (or learning) mode and can be programmed at any time beginning with "Programming" - Step 2.

Reprogramming a Single HomeLink Button

To program a device to HomeLink using a HomeLink button previously trained, follow these steps:

1. Press and hold the desired HomeLink button. **Do NOT** release the button.

2. The EVIC display will show "CHANNEL X TRANSMIT" (where X is Channel 1, 2, or 3) for 20 seconds and then change to "CHANNEL X TRAINING." Without releasing the HomeLink button, proceed with "Programming" Step 2.

For questions or comments, contact HomeLink at: www.homelink.com or 1-800-355-3515.

Security

If you sell your vehicle, be sure to erase the frequencies by following the "Erasing HomeLink Buttons" instructions in this section.

This device complies with part 15 of FCC rules and with RSS-210 of Industry Canada. Operation is subject to the following conditions:

- This device may not cause harmful interference.
- This device must accept any interference that may be received including interference that may cause undesired operation.

NOTE: Changes or modifications not expressly approved by the party responsible for compliance could void the user's authority to operate the equipment.

HomeLink® is a trademark owned by Johnson Controls, Inc.

POWER SUNROOF — IF EQUIPPED

The power sunroof switch is located between the sun visors on the overhead console.

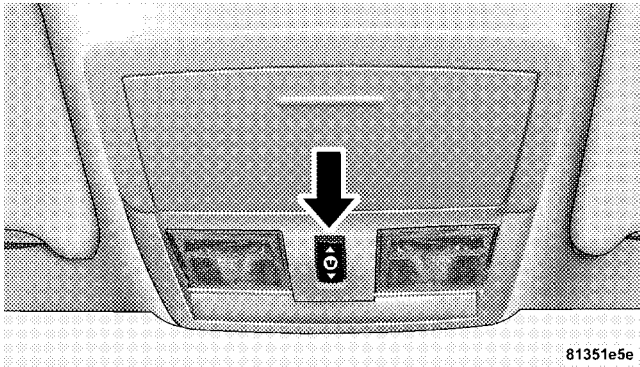

Power Sunroof Switch

WARNING!

- Never leave children in a vehicle, with the keys in the ignition switch. Occupants, particularly unattended children, can become entrapped by the power sunroof while operating the power sunroof switch. Such entrapment may result in serious injury or death.
- In an accident, there is a greater risk of being thrown from a vehicle with an open sunroof. You could also be seriously injured or killed. Always fasten your seat belt properly and make sure all passengers are properly secured too.
- Do not allow small children to operate the sunroof. Never allow fingers or other body parts, or any object to project through the sunroof opening. Injury may result.

Opening Sunroof - Express

Press the switch rearward and release, and the sunroof will open automatically from any position. The sunroof will open fully, then stop automatically. This is called Express Open. During Express Open operation, any movement of the sunroof switch will stop the sunroof.

Closing Sunroof - Express

Press the switch forward and release, and the sunroof will close automatically from any position. The sunroof will close fully and stop automatically. This is called Express Close. During Express Close operation, any movement of the switch will stop the sunroof.

Pinch Protect Feature

This feature will detect an obstruction in the opening of the sunroof during Express Close operation. If an obstruction in the path of the sunroof is detected, the

sunroof will automatically retract. Remove the obstruction if this occurs. Next, press the switch forward and release to Express Close.

Pinch Protect Override

If a known obstruction (ice, debris, etc.) prevents closing, press the switch forward and hold for two seconds after the reversal occurs. This allows the sunroof to move towards the closed position.

NOTE: Pinch protection is disabled while the switch is pressed.

Venting Sunroof - Express

Press and release the "V" button, and the sunroof will open to the vent position. This is called Express Vent, and will occur regardless of sunroof position. During Express Vent operation, any movement of the switch will stop the sunroof.

Sunshade Operation

The sunshade can be opened manually. However, the sunshade will open automatically as the sunroof opens.

NOTE: The sunshade cannot be closed if the sunroof is open.

Wind Buffeting

Wind buffeting can be described as the perception of pressure on the ears or a helicopter type sound in the ears. Your vehicle may exhibit wind buffeting with the windows down, or the sunroof (if equipped) in certain open or partially open positions. This is a normal occurrence and can be minimized. If the buffeting occurs with the rear windows open, open the front and rear windows together to minimize the buffeting. If the buffeting occurs with the sunroof open, adjust the sunroof opening to minimize the buffeting or open any window.

Sunroof Maintenance

Use only a non-abrasive cleaner and a soft cloth to clean the glass panel.

Ignition Off Operation

The power sunroof switches remain active for 10 minutes after the ignition switch has been turned off. Opening either front door will cancel this feature.

Sunroof Fully Closed

Press the switch forward and release to ensure that the sunroof is fully closed.

POWER OUTLET

To the right of the convenience tray (lower center of instrument panel) is an outlet for electrically powered accessories. Pull lightly on the tab of the plastic cover to access the outlet.

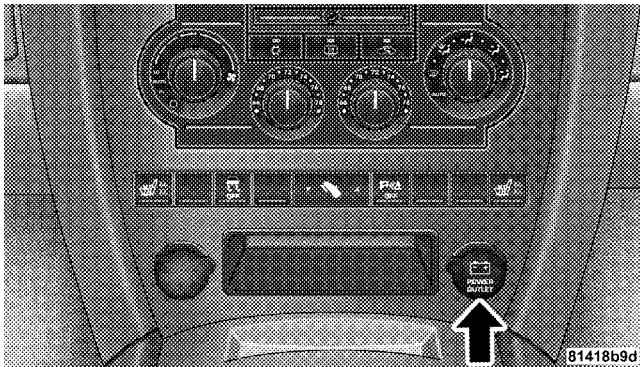

Front Power Outlet

The rear power outlet (if equipped) is located in the left rear cargo area.

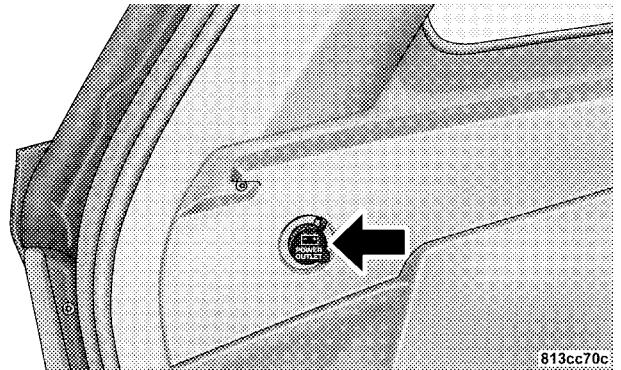

Rear Power Outlet

The power outlets are a direct feed from the battery so they receive power whether the ignition is in the ON or OFF position.

All accessories connected to this outlet should be removed or turned off when the vehicle is not in use to protect the battery against discharge.

CAUTION!**Electrical Outlet Use With Engine Off**

- Many accessories that can be plugged in draw power from the vehicle's battery, even when not in use (i.e., cellular phones, etc.). Eventually, if plugged in long enough, the vehicle's battery will discharge sufficiently to degrade battery life and/or prevent engine starting.
- Accessories that draw higher power (i.e., coolers, vacuum cleaners, lights, etc.) will degrade the battery even more quickly. Only use these intermittently and with greater caution.
- After the use of high power draw accessories, or long periods of the vehicle not being started (with accessories still plugged in), the vehicle must be driven a sufficient length of time to allow the generator to recharge the vehicle's battery.

CUP HOLDERS

In the center console there are two cup holders for the front seat passengers.

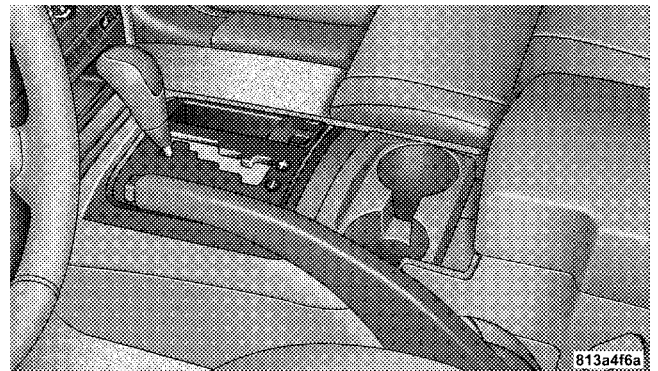

Front Cup Holders

NOTE: The cup holder insert is removable, from the console, for cleaning. It can be reinstalled with the larger

cup depression towards the passenger seat, but the top surface will not be flush with the console surface.

The rear passengers have access to two cup holders that pull out from the lower center of the rear seat.

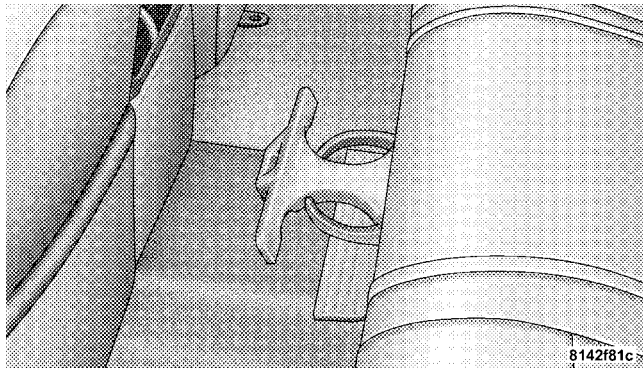

Rear Cup Holders

CARGO AREA FEATURES

Cargo Light

The cargo area light is activated by opening the liftgate, opening any door, or by rotating the dimmer control on the multi-function control lever to the extreme top position. If all doors are closed and only the liftgate is open, pushing on the cargo light lens surface will turn off all interior lamps. Push on the lens surface a second time to restore the interior lights to normal operation.

Rear Storage Compartment

The rear storage compartment is located behind the left rear seat.

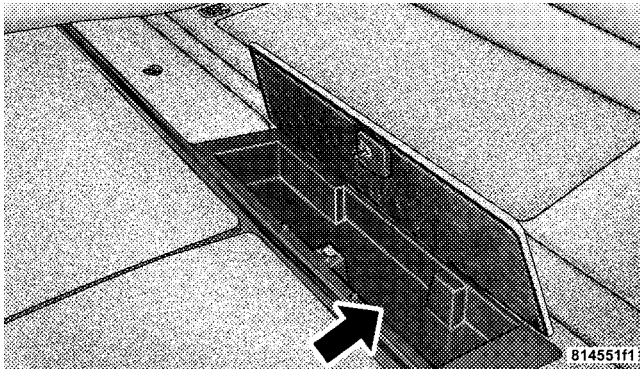

Rear Storage Compartment

Retractable Cargo Area Cover — If Equipped

NOTE: The purpose of this cover is for privacy, not to secure loads. It will not prevent cargo from shifting or protect passengers from loose cargo.

To cover the cargo area:

1. Grasp the cover at the center handle. Pull it over the cargo area.
2. Insert the pins on the ends of the cover into the slots in the pillar trim cover.

152 UNDERSTANDING THE FEATURES OF YOUR VEHICLE

3. The liftgate may be opened with the cargo cover in place.

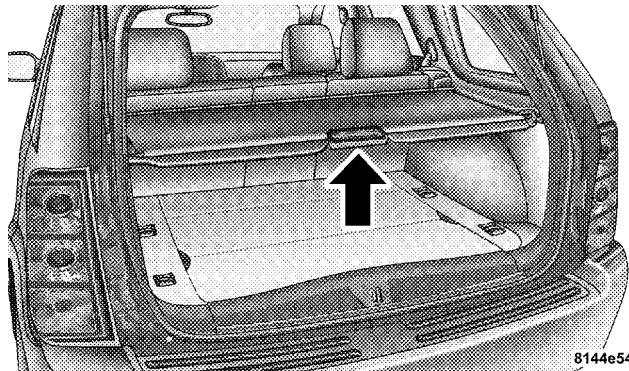

Rear Cargo Cover

WARNING!

In an accident a cargo cover loose in the vehicle could cause injury. It could fly around in a sudden stop and strike someone in the vehicle. Do not store the cargo cover on the cargo floor or in the passenger compartment. Remove the cover from the vehicle when taken from its mounting. Do not store in the vehicle.

Cargo Tie-Down Hooks

The tie-downs located on cargo area floor should be used to safely secure loads when vehicle is moving.

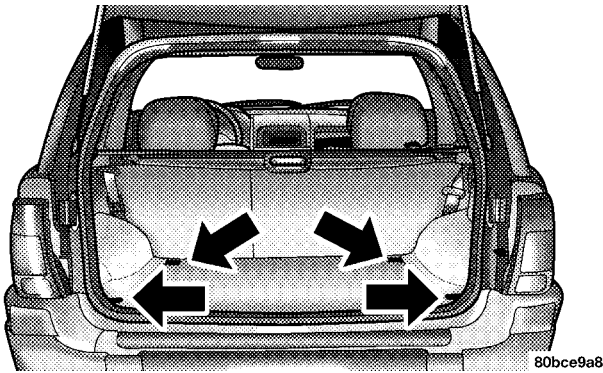

Cargo Tie-Down Hooks

80bce9a8

WARNING!

Cargo tie-down hooks are not safe anchors for a child seat tether strap. In a sudden stop or collision a hook could pull loose and allow the child seat to come loose. A child could be badly injured. Use only the anchors provided for child seat tethers.

3

WARNING!

The weight and position of cargo and passengers can change the vehicle center of gravity and vehicle handling. To avoid loss of control resulting in personal injury, follow these guidelines for loading your vehicle:

- Do not carry loads which exceed the load limits described on the label attached to the left door or left door center pillar. Refer to “Vehicle Loading” in Section 5 for additional information on cargo weights.
- Always place cargo evenly on the cargo floor. Put heavier objects as low and as far forward as possible.
- Place as much cargo as possible in front of the rear axle. Too much weight or improperly placed weight over or behind the rear axle can cause the rear of the vehicle to sway.
- Do not pile luggage or cargo higher than the top of the seatback. This could impair visibility or become a dangerous projectile in a sudden stop or collision.

WARNING!

To help protect against personal injury, passengers should not be seated in the rear cargo area. The rear cargo space is intended for load carrying purposes only, not for passengers, who should sit in seats and use seat belts.

Cargo Load Floor

The panel in the load floor is reversible for added utility. One side is carpeted and the other side features a plastic lined tray which holds a variety of items.

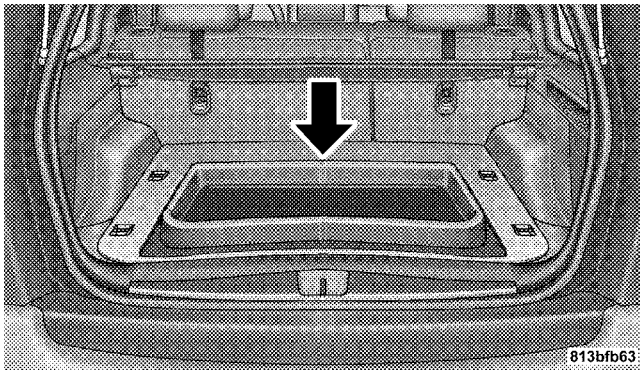

Cargo Load Floor

The cargo load floor is held by spring loaded latches. In order to use the cargo load floor, use the following procedure:

NOTE: The cargo load floor latches should not be used as cargo tie-downs.

1. Flip up pull loop(s) so they are perpendicular (straight up) to the top surface of the tray.
2. Pull up on loop(s) and twist 90 degrees, so they are parallel to the slotted hole in tray.
3. Lift tray over loop(s), and reposition tray.
4. Pull up on loop(s) and twist 90 degrees, so they are perpendicular (straight up) to the slotted hole in tray.
5. Push loop(s) back down, so they are parallel to the top of the tray.

3

REAR WINDOW FEATURES

Rear Window Wiper/Washer

A switch on the right side of the steering column controls operation of the rear wiper/washer function. Rotating the center of the switch up to the DEL (Delay) position or the ON position will activate the wiper. Rotating the center of the switch all the way up or down will turn on

the wash function. The wash pump will continue to operate as long as the button is pressed. Upon release, the wipers will cycle three times before returning to the set position.

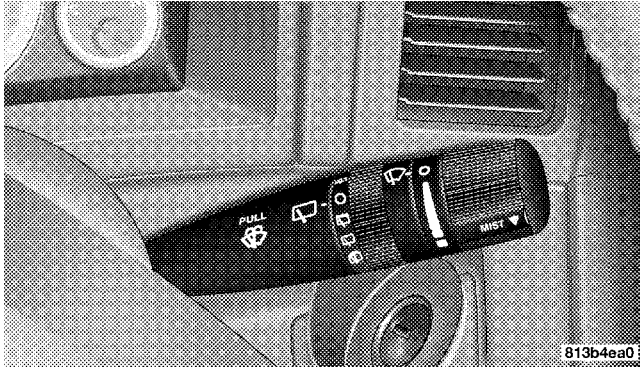

Rear Wiper/Washer Switch

If the rear wiper is operating when the ignition is turned OFF, the wiper will automatically return to the “Park” position.

If the liftgate flipper glass is open, connection to the rear window wiper is interrupted preventing activation of the rear wiper blade. When the liftgate flipper glass is closed, the rear wiper switch or the ignition switch needs to be turned OFF and ON to restart the rear wiper.

Adding Washer Fluid

The fluid reservoir for the windshield washers and the rear window washer is shared. It is located in the front of the engine compartment on the passenger side and should be checked for fluid level at regular intervals. Fill the reservoir with windshield washer solvent (not radiator antifreeze) and operate the system for a few seconds to flush out the residual water.

ROOF LUGGAGE RACK — IF EQUIPPED

External racks do not increase the total load carrying capacity of the vehicle. Be sure that the total occupant and luggage load inside the vehicle, plus the load on the luggage rack, do not exceed the rated vehicle capacity.

This vehicle is not equipped with roof rack cross rails as built, unless ordered as optional equipment. Cross rails must be installed prior to carrying loads on the roof rack. If not equipped, your authorized dealer can order and install Mopar® cross rails built specifically for this roof rack system or a number of after market rails that are tailored to your life-style or activities.

NOTE: The optional cross rails have seven specific locations identified by a feature on both the side rail and the cross rail. Cross rails must be secured in one of the seven detent locations on the side rail to prevent movement with a sudden stop. For improved windnoise performance when cross rails are not in use, place them in detent positions #2 (second detent from the front of the vehicle) and #7 (detent closest to the rear of the vehicle) as indicated with a unique feature on the side rails.

CAUTION!

- To prevent damage to the roof of your vehicle, **DO NOT** carry any loads on the roof rack without cross rails installed. The load should be secured and placed on top of the cross rails, not directly on the roof. If it is necessary to place the load on the roof, place a blanket or some other protection between the load and the roof surface.
- To avoid damage to the roof rack and vehicle, do not exceed the rated load capacity of your cross rail system or the roof rack system maximum load capacity of 150 lbs (68 kg). Always distribute heavy loads as evenly as possible and secure the load appropriately.
- Long loads which extend over the windshield, such as wood panels or surfboards, should be secured to both the front and rear of the vehicle.
- Travel at reduced speeds and turn corners carefully when carrying large or heavy loads on the roof rack. Wind forces, due to natural causes or nearby truck traffic, can add sudden upward loads. This is especially true on large flat loads and may result in damage to the cargo or your vehicle.

WARNING!

Cargo must be securely tied before driving your vehicle. Improperly secured loads can fly off the vehicle, particularly at high speeds, resulting in personal injury or property damage. Follow the roof rack "Cautions" when carrying cargo on your roof rack.

UNDERSTANDING YOUR INSTRUMENT PANEL

CONTENTS

■ Instrument Panel And Interior Controls	162	□ Radio Broadcast Signals	184
■ Instrument Cluster	163	□ Two Types Of Signals	185
■ Instrument Cluster Description	164	□ Electrical Disturbances	185
■ Electronic Vehicle Information Center — If Equipped	171	□ AM Reception	185
□ Customer Programmable Features	174	□ FM Reception	185
□ Compass/Temperature/Trip Computer	178	■ Sales Code RAQ – AM/FM/CD (6-Disc) Radio With Optional Satellite Radio, Hands Free Phone, And Vehicle Entertainment Systems (VES) Capabilities	186
□ Trip Computer	180	□ Operating Instructions - Radio Mode	186
■ Radio General Information	184		

160 UNDERSTANDING YOUR INSTRUMENT PANEL

<ul style="list-style-type: none"> □ Operation Instructions - (CD Mode For CD Audio Play)191 □ Load/Eject Button (CD Mode For CD Audio Play)193 □ Notes On Playing MP3 Files195 □ Operation Instructions - (CD Mode For MP3 Audio Play)197 □ Load/Eject Button (CD Mode For MP3 Play) ..197 ■ Sales Code REF — AM/FM/CD (Single Disc) Radio With Optional Satellite Radio And Hands Free Phone Capability200 □ Operating Instructions - Radio Mode200 □ Operation Instructions - CD Mode204 □ Operating Instructions - Hands Free Phone — If Equipped206 	<ul style="list-style-type: none"> □ Operating Instructions - Satellite Radio — If Equipped206 ■ Sales Code REC — AM/FM/CD (6-Disc) Radio With Navigation System206 ■ Satellite Radio — If Equipped207 □ System Activation207 □ Electronic Serial Number/Sirius Identification Number (ESN/SID)207 □ Selecting Satellite Mode In REF Radios208 □ Selecting Satellite Mode In RAQ Radios208 □ Selecting a Channel209 □ Storing And Selecting Pre-Set Channels209 □ Using The PTY (Program Type) Button (If Equipped)209
---	--

□ PTY Button "Scan"	209	□ Climate Controls — Manual	213
□ PTY Button "Seek"	210	□ Operating Tips	217
□ Satellite Antenna	210	□ Automatic Temperature Control — If Equipped	218
□ Reception Quality	210	□ Summer Operation	224
■ Remote Sound System Controls — If Equipped	211	□ Winter Operation	224
□ Radio Operation	211	□ Vacation Storage	224
□ CD Player	212	□ Window Fogging	225
■ CD/DVD Disc Maintenance	212	□ Outside Air Intake	225
■ Radio Operation And Cellular Phones	213		
■ Climate Controls	213		

INSTRUMENT PANEL AND INTERIOR CONTROLS

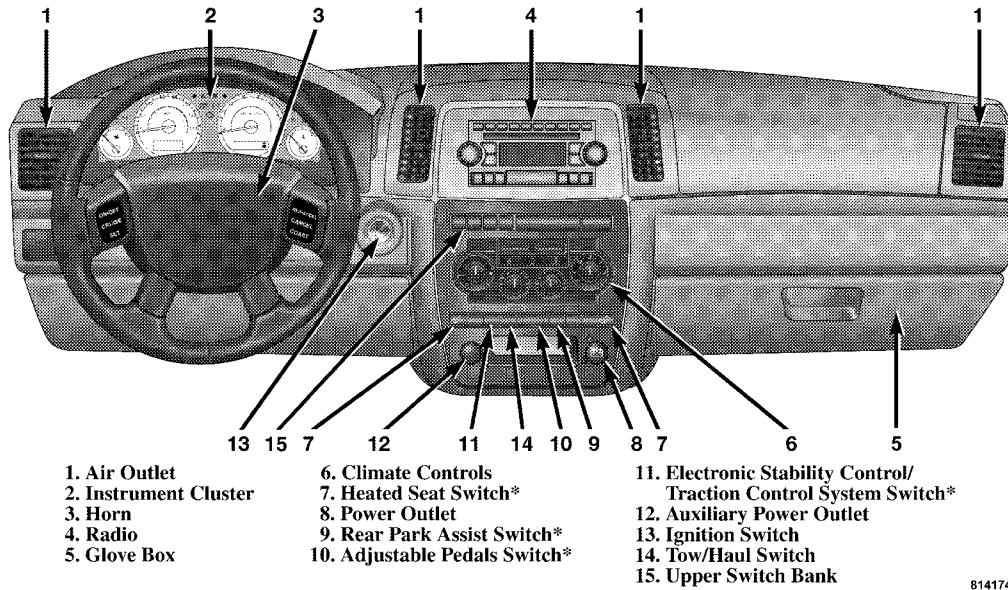

INSTRUMENT CLUSTER

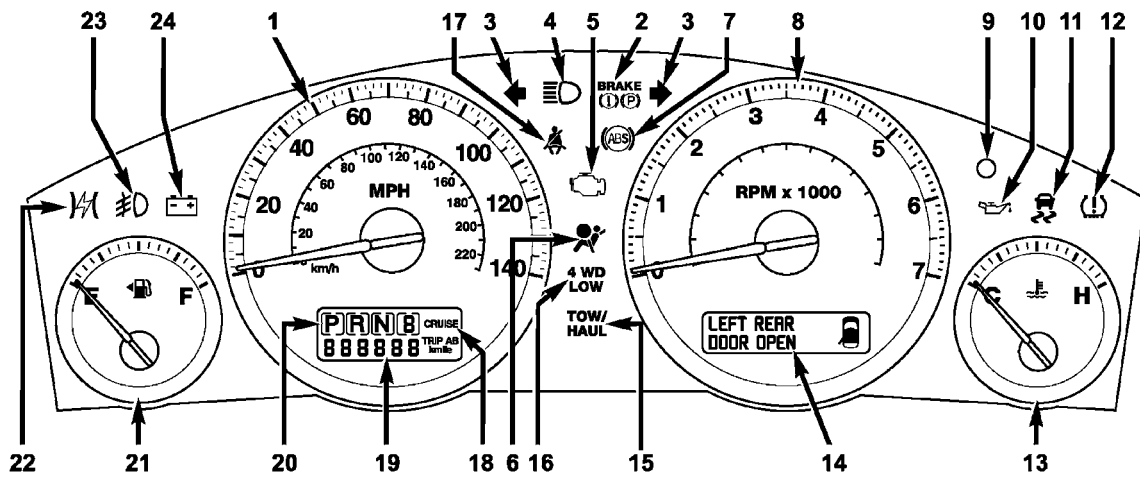

INSTRUMENT CLUSTER DESCRIPTION**1. Speedometer**

Indicates vehicle speed.

2. Brake Warning Light

The red BRAKE warning light will come on when the ignition is first turned on, and stay on briefly as a bulb check. If the bulb does not come on during starting, have the bulb repaired promptly. If the light stays on longer, it may be an indication that the parking brake has not been released.

If the light remains on when the parking brake is off, it indicates a possible brake hydraulic system malfunction or low fluid level. In this case, the light will remain on until the cause is corrected. If a brake malfunction is indicated, immediate repair is necessary and continued operation of the vehicle in this condition is dangerous.

3. Turn Signal Indicator Light

The arrow will flash with the exterior turn signal when the turn signal lever is operated.

If the vehicle electronics sense that the vehicle has traveled about one mile with the turn signals on, a chime will sound to alert you to turn the signals off. If either indicator flashes at a rapid rate, check for a defective outside light bulb.

4. High Beam Indicator Light

Indicates that headlights are on high beam.

5. Malfunction Indicator Light

This light is part of an onboard diagnostic system called OBD that monitors engine and automatic transmission control systems. The light will illuminate when the key is in the ON position before engine start. If the bulb does not come on when turning the key from OFF to ON, have the condition checked promptly.

Certain conditions such as a loose or missing gas cap, poor fuel quality, etc. may illuminate the light after engine start. The vehicle should be serviced if the light stays on through several of your typical driving cycles. In most situations the vehicle will drive normally and will not require towing.

The Malfunction Indicator Light flashes to alert you to serious conditions that could lead to immediate loss of power or severe catalytic converter damage. The vehicle should be serviced as soon as possible if this occurs. (See page 313 for more information.)

6. Airbag Warning Light



This light turns on and remains on for 6 to 8 seconds as a bulb check when the ignition switch is first turned ON. If the light is not on during starting, stays on, or turns on while driving, have the system inspected by an authorized dealer as soon as possible.

7. Anti-Lock Brake Warning Light



This light monitors the Anti-Lock Brake System. The light will turn on when the ignition switch is turned to the ON position and may stay on for as long as four seconds.

If the ABS light remains on or turns on while driving, it indicates that the Anti-Lock portion of the brake system is not functioning and that service is required. However, the conventional brake system will continue to operate normally if the BRAKE warning light is not on.

If the ABS light is on, the brake system should be serviced as soon as possible to restore the benefits of Anti-Lock brakes. If the ABS light does not turn on when the Ignition switch is turned to the ON position, have the light inspected by an authorized dealer.

8. Tachometer

The red segments indicate the maximum permissible engine revolutions-per-minute (r.p.m. x 1000) for each gear range. Before reaching the red area, ease up on the accelerator.

9. Security Alarm System Indicator Light — If Equipped

This light will flash rapidly for approximately 15 seconds when the vehicle theft alarm is arming. The light will flash at a slower speed continuously after the alarm is set. The security light will also come on for about three seconds when the ignition is first turned on.

10. Oil Pressure Warning Light

 This light shows low engine oil pressure. The light should turn on momentarily when the engine is started. If the light turns on while driving, stop the vehicle, and shut off the engine as soon as possible. A continuous chime will sound when this light turns on.

Do not operate the vehicle until the cause is corrected. This light does not show how much oil is in the engine. The engine oil level must be checked under the hood.

11. Electronic Stability Program (ESP) Indicator Light/Traction Control System (TCS) Indicator Light — If Equipped

If this indicator light flashes during acceleration, apply as little throttle as possible. While driving, ease up on the accelerator. Adapt your speed and driving to the prevailing road conditions, and do not switch off the ESP, or TCS — if equipped. The indicator light will flash when the ESP or TCS System is active and helping to improve vehicle stability. If the indicator light is on solid, ESP or TCS may not be able to function normally.

12. Tire Pressure Monitor Warning Light



This light will turn on continuously when there is a low tire pressure condition. The light will also turn on if a problem exists with any tire sensor. When a system fault is detected, the indicator lamp will flash repetitively for ten seconds. The flash cycle will repeat every ten minutes or until the fault condition is removed and reset. The light will remain on or flashing until the tire pressure is properly set or the problem with the sensor is corrected.

This light will turn on momentarily as a bulb check when the engine is started.

When the tire pressure monitoring system warning light is lit, one or more of your tires is significantly underinflated. You should stop and check your tires as soon as possible, and inflate them to the proper pressure as indicated on the tire and loading information placard. Driving on a significantly underinflated tire causes the

tire to overheat and can lead to tire failure. Underinflation also reduces fuel efficiency and tire tread life, and may affect the vehicle's handling and stopping ability. Each tire, including the spare, should be checked monthly when cold and set to the recommended inflation pressure as specified in the tire and loading information placard. (See page 269 for more information.)

13. Temperature Gauge

The temperature gauge shows engine coolant temperature. Any reading within the normal range indicates that the engine cooling system is operating satisfactorily.

The gauge pointer will likely indicate a higher temperature when driving in hot weather, up mountain grades, or when towing a trailer. It should not be allowed to exceed the upper limits of the normal operating range.

CAUTION!

Driving with a hot engine cooling system could damage your vehicle. If temperature gauge reads (H), pull over and stop the vehicle. Idle the vehicle with the air conditioner turned off until the pointer drops back into the normal range. If the pointer remains on the "H", and you hear continuous chimes, turn the engine off immediately, and call for service.

WARNING!

A hot engine cooling system is dangerous. You or others could be badly burned by steam or boiling coolant. If you decide to look under the hood yourself, refer to Section 7 of this manual. Follow the warnings under "Cooling System Pressure Cap."

14. Electronic Vehicle Information Center Display

When the appropriate conditions exist, this display shows the Electronic Vehicle Information Center (EVIC) messages. Refer to "Electronic Vehicle Information Center" later in this section. (See page 171 for more information.)

15. TOW/HAUL Indicator Light**TOW/
HAUL**

This light will illuminate when the TOW/HAUL button has been selected. The TOW/HAUL button is located in the center of the instrument panel (below the climate controls).

16. 4WD LOW Mode Indicator Light — If Equipped**4 WD
LOW**

This light alerts the driver that the vehicle is in the 4WD LOW mode. The front and rear drive-shafts are mechanically locked together forcing the front and rear wheels to rotate at the same speed. (See page 239 for more information.)

17. *Seat Belt Reminder Light*



When the ignition switch is first turned ON, this light will turn on for 5 to 8 seconds as a bulb check.

During the bulb check, if the driver's seat belt is unbuckled, a chime will sound. After the bulb check or when driving, if the driver seat belt remains unbuckled, the Seat Belt Warning Light will flash or remain on continuously. Refer to "Enhanced Driver Seat Belt Reminder System (BeltAlert)" in the Occupant Restraints section for more information.

18. *Cruise Indicator Light*

CRUISE This indicator lights when the speed control system is turned ON.

19. *Odometer/Trip Odometer*

The odometer shows the total distance the vehicle has been driven. The trip odometer shows individual trip mileage.

U.S. federal regulations require that upon transfer of vehicle ownership, the seller certify to the purchaser the correct mileage that the vehicle has been driven. Therefore, if the odometer reading is changed during repair or replacement, be sure to keep a record of the reading before and after the service so that the correct mileage can be determined.

20. *Transmission Range Indicator*

This display indicator shows the automatic transmission gear selection.

21. *Fuel Gauge*

The pointer shows the level of fuel in the fuel tank when the ignition switch is in the ON position.

22. Electronic Throttle Control (ETC) Warning Light — If Equipped (5.7L Engine Only)

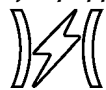

This light informs you of a problem with the Electronic Throttle Control system. If a problem is detected the light will come on while the engine is running. Cycle the ignition key when the vehicle has completely stopped and the gear selector is placed in the P (Park) position. The light should turn off. If the light remains lit with the engine running your vehicle will usually be drivable, however, see your dealer for service as soon as possible. If the light is flashing when the engine is running, immediate service is required and you may experience reduced performance, an elevated/rough idle or engine stall and your vehicle may require towing. The light will come on when the ignition is first turned on and remain on briefly as a bulb check. If the light does not come on during starting, have the system checked by an authorized dealer.

23. Front Fog Light Indicator Light— If Equipped



This light shows the front fog lights are ON.

24. Voltage Warning Light



This light monitors the electrical system voltage. The light should turn on momentarily as the engine is started. If the light stays on or turns on while driving, it indicates a problem with the charging system. Immediate service should be obtained.

ELECTRONIC VEHICLE INFORMATION CENTER — IF EQUIPPED

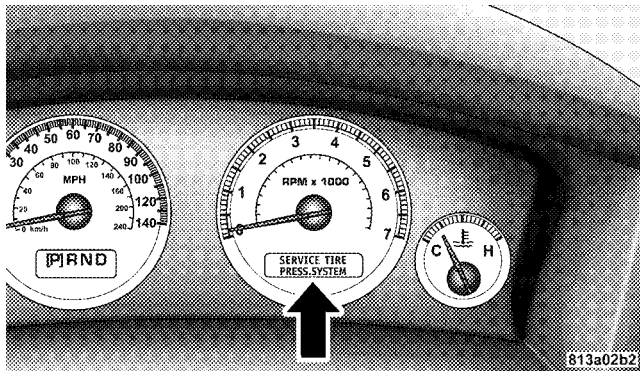

The electronic vehicle information center (EVIC) located in the instrument cluster, when the appropriate conditions exist, will display the following messages and symbols. Some of the messages are accompanied by a chime.

- TURN SIGNAL ON
- PERFORM SERVICE
- KEY NOT PROGRAMMED — DAMAGED KEY
- KEY NOT PROGRAMMED — INVALID KEY
- KEY NOT PROGRAMMED — EXCEEDED KEY PROGRAM LIMIT
- PROGRAMMING ACTIVE — NEW KEY PROGRAMMED
- SERVICE SECURITY KEY
- INVALID KEY — TRY ALTERNATE KEY
- DRIVER/PASSENGER DOOR OPEN (with graphic)
- LEFT/RIGHT REAR DOOR OPEN (with graphic)
- X DOORS OPEN (with graphic)
- LIFTGATE OPEN (with graphic)

172 UNDERSTANDING YOUR INSTRUMENT PANEL

- LIFTGATE/DOOR OPEN (with graphic)
- LIFTGATE/DOORS OPEN (with graphic)
- LIFTGLASS OPEN (with graphic)
- HOOD OPEN (with graphic)
- HOOD/DOOR OPEN (with graphic)
- HOOD/DOORS OPEN (with graphic)
- LIFTGATE/HOOD OPEN (with graphic)
- HOOD/GLASS/DOOR OPEN (with graphic)
- HOOD/GLASS/DOORS OPEN (with graphic)
- HOOD/GATE/DOOR OPEN (with graphic)
- HOOD/GATE/DOORS OPEN (with graphic)
- LIFTGLASS/DOOR OPEN (with graphic)
- LIFTGLASS/DOORS OPEN (with graphic)
- LIFTGLASS/HOOD OPEN (with graphic)
- WASHER FLUID LOW (with graphic)
- FUEL LOW (with graphic)
- CHECK GAUGES
- AUTO HIGHBEAM ON
- AUTO HIGHBEAM OFF
- PARK ASSIST DISABLED
- SERVICE PARK ASSIST SYSTEM
- TRANSMISSION OVER TEMP
- CHECK SHIFT PROCEDURE
- SERVICE 4WD SYSTEM
- 4WD SYSTEM IN NEUTRAL
- LOW BRAKE FLUID LEVEL

- WARNING! LIMIT SPEED
- CHECK GAS CAP
- ESP SYSTEM DISABLED
- SERVICE ELEC BRAKE SYSTEM
- TRACTION SYS DISABLED
- MEMORY #1 POSITIONS SET
- MEMORY #2 POSITIONS SET
- MEMORY SYSTEM DISABLED — SEATBELT FASTENED (with graphic)
- MEMORY SYSTEM DISABLED — VEHICLE NOT IN PARK
- DRIVER 1 MEMORY
- DRIVER 2 MEMORY
- PEDAL ADJUST DISABLED — CRUISE CONTROL SET
- PEDAL ADJUST DISABLED — SHIFTER IN REVERSE
- SERVICE TIRE PRESS SYSTEM
- LEFT FRONT LOW PRESSURE (Premium TPM System Only)
- RIGHT FRONT LOW PRESSURE (Premium TPM System Only)
- LEFT REAR LOW PRESSURE (Premium TPM System Only)
- RIGHT REAR LOW PRESSURE (Premium TPM System Only)
- SPARE LOW PRESSURE (Premium TPM System Only)

Customer Programmable Features

Press the MENU button until one of the display choices following appears:

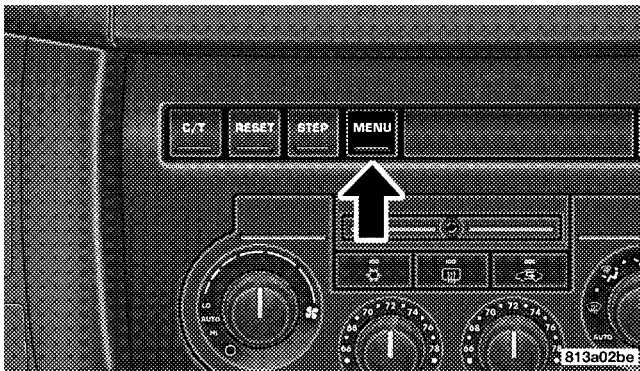

Menu Button

Language?

When in this display you may select one of three languages for all display nomenclature, including the trip

computer functions. Press the STEP button while in this display selects English, Espanol, or Francais. As you continue the displayed information will be shown in the selected language.

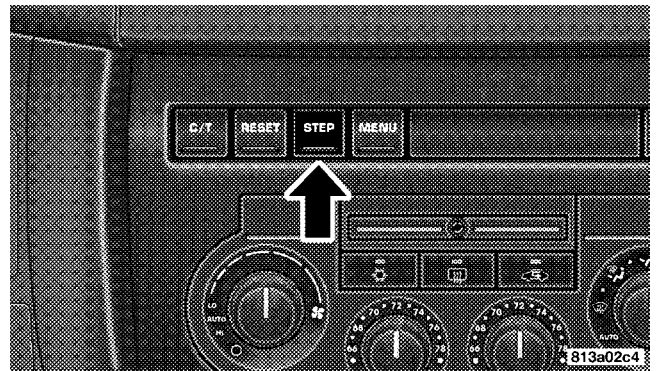

Step Button

Display U.S. or Metric?

Pressing the STEP button when in this display selects US or Metric. The overhead console and instrument panel displays will be in the selected units.

Auto Door Locks?

When this feature is selected, all doors and the liftgate lock automatically when the speed of the vehicle reaches 15 mph (25 km/h). Pressing the STEP button when in this display will select "Yes" or "No."

Auto Unlock On Exit? (Available Only When the AUTO DOOR LOCKS Feature is Turned On)

When this feature is selected all the vehicle's doors will unlock when the driver's door is opened if the vehicle is stopped and the transmission is in P (Park) or N (Neutral) position. Pressing the STEP button when in this display will select "Yes" or "No."

Remote Unlock Driver's Door 1st?

When this feature is selected only the driver's door will unlock on the first press of the remote keyless entry unlock button and require a second press to unlock the remaining locked doors and liftgate. When **REMOTE UNLOCK ALL DOORS** is selected all of the doors and the liftgate will unlock at the first press of the remote keyless entry unlock button. Pressing the STEP button when in this display will select DRIVER'S DOOR 1ST or ALL DOORS.

Remote Linked To Memory? (Available with Memory Seat Only)

When this feature is selected the memory seat, mirror, and radio settings will return to the memory set position when the remote keyless entry "Unlock" button is pressed. If this feature is not selected then the memory seat, mirror, and radio settings can only return to the

memory set position using the door mounted switch. Pressing the STEP button when in this display will select "Yes" or "No."

Sound Horn With Lock?

When this feature is selected a short horn sound will occur when the remote keyless entry "Lock" button is pressed. This feature may be selected with or without the flash lights on lock/unlock feature. Pressing the STEP button when in this display will select "Yes" or "No."

Flash Lights With Lock?

When this feature is selected, the front and rear turn signals will flash when the doors are locked or unlocked using the remote keyless entry transmitter. This feature may be selected with or without the sound horn on lock feature selected. Pressing the STEP button when in this display will select "Yes" or "No."

Headlamp Delay

When this feature is selected the driver can choose, when exiting the vehicle, to have the headlamps remain on for 30, 60, or 90 seconds, or not remain on. Pressing the STEP button when in this display will select 30, 60, 90, or OFF.

Illuminated Approach?

When this feature is selected the driver can choose, when entering the vehicle, to have the headlamps come on for 30, 60, or 90 seconds, or not come on at all. Pressing the STEP button when in this display will select 30, 60, 90, or OFF.

Auto Headlamp Low/High Beams?

When this feature is selected and the headlight switch has been moved to the A (Auto) position, the headlights will automatically switch from high to low beams when approaching a vehicle. Pressing the STEP button when in

this display will select “Low Beam” or “Low/High Beam.” Refer to “Lights — SmartBeams” in Section 3 of this manual.

NOTE: System will activate at or above 20 mph (32 km/h).

Headlamps On With Wipers? (Available with Auto Headlights Only)

When this feature is selected and the headlight switch has at least once been moved to the A (Auto) position, the headlights will turn on when the wipers are turned on. The headlights will also turn off when the wipers are turned off if they were turned on in this way. Pressing the STEP button when in this display will select “Yes” or “No.”

NOTE: Turning the headlights on during the daytime causes the instrument panel lights to dim. To increase the brightness, refer to “Lights” in this section.

Front Wipers Rain Sense?

Pressing the STEP button when in this display will select “Manual” or “Rain Sense.”

Service Interval

When this feature is selected a service interval between 2,000 (3 200 km) and 6,000 miles (10 000 km) in 500 mile (800 km) increments may be selected. Pressing the STEP button when in this display will select distances between 2,000 (3 200 km) and 6,000 miles (10 000 km) in 500 mile (800 km) increments.

Reset Service Distance (Displays Only if Service Interval was Changed)

When this feature is selected the current accumulated service distance can be reset to the newly selected service interval. Pressing the STEP button when in this display will select “Yes” or “No.”

Easy Entry/Exit Seat? (Available with Memory Seat Only)

When this feature is selected, the driver's seat moves rearward 2 inches (5 cm) or to the farthest rearward position if this distance is less than 2 inches (5 cm) when the key is removed from the ignition switch so that the driver can more easily exit the vehicle. The seat will return to the memorized seat location (if REMOTE LINK TO MEMORY is set to YES) when the remote keyless entry transmitter is used to unlock the door. Pressing the STEP button when in this display will select "Yes" or "No."

Compass/Temperature/Trip Computer

This display provides the outside temperature, one of the eight compass headings to indicate the direction the vehicle is facing, and vehicle trip information. The compass and temperature display is the normal display. When the C/T button is pressed the compass/temperature display returns.

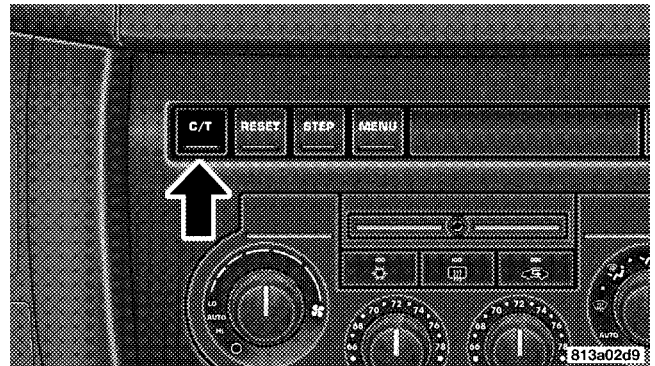

Compass/Temperature Button

WARNING!

Even if the display still reads a few degrees above 32°F (0°C), the road surface may be icy, particularly in woods or on bridges. Drive carefully under such conditions to prevent an accident and possible personal injury or property damage.

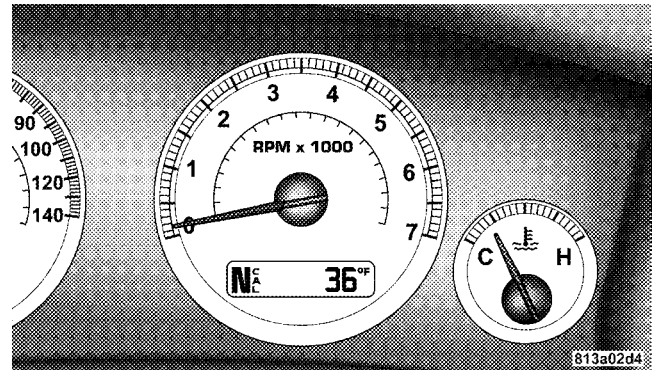

Compass/Temperature Display

Trip Computer

This feature, located in the instrument cluster, displays the following information when the display is in the "Compass/Temperature" mode and the STEP button is pressed:

Step Button

Press the STEP button to cycle through all of the Compass/Mini-Trip Computer displays.

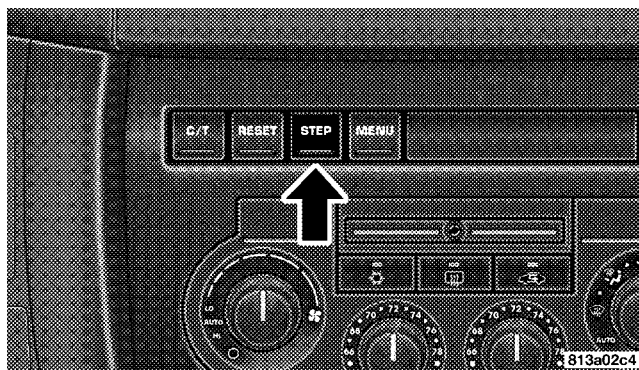

Step Button

Reset Button

Press the RESET button (for 5 seconds) to reset the display you are in. Press and hold the RESET button (for 10 seconds) to reset all of the displays.

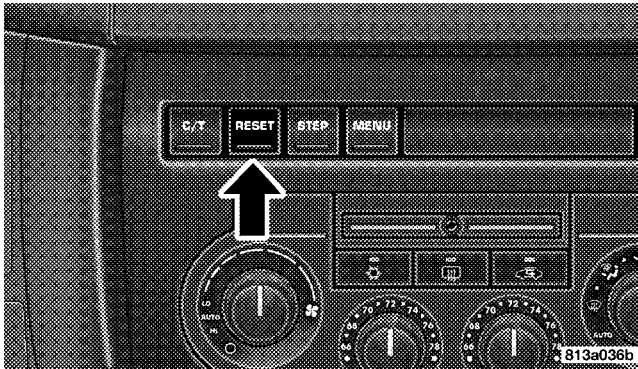

Reset Button

Average Fuel Economy

Shows the average fuel economy since the last reset.

Distance To Empty

Shows the estimated distance that can be travelled with the fuel remaining in the tank. This is calibrated using the miles per gallon during the last driving period.

Trip A

Shows the total distance travelled for trip A since the last reset.

Trip B

Shows the total distance travelled for trip B since the last reset.

Elapsed Time

Shows the accumulated ignition ON time since the last reset.

Tire Pressure Display — If Equipped

Shows the current pressure of all 4 road tires.

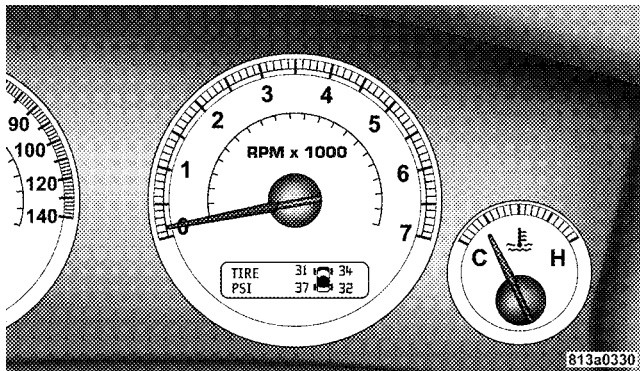

Tire Pressure Display

NOTE: Tires heat up during normal driving conditions. Heat will cause the tire pressure to increase from 2 to 6 psi (14 to 41 kPa) during normal driving conditions. Refer to “Tire Inflation Pressures” in Section 5 for additional information.

Miles to Service

Shows the distance remaining to require service.

NOTE: This display can be reset to the set service interval by pressing and holding the RESET button for 3 seconds.

Blank Screen

Shows a blank screen. Pressing the C/T button returns to the compass/temperature display.

Automatic Compass Calibration

This compass is self-calibrating which eliminates the need to manually set the compass. When the vehicle is new, the compass may appear erratic and the CAL symbol will be displayed.

After completing one 360 degree turn, with the vehicle traveling less than 5 mph (8 km/h), in an area free from large metal or metallic objects, the CAL symbol will turn off and the compass will function normally.

Manual Compass Calibration

If the compass appears erratic and the CAL symbol does not appear, you must manually put the compass into the “Calibration” mode.

NOTE: To ensure proper compass calibration, make sure the compass variance is properly set before manually calibrating the compass. Refer to Variance Map.

To Put Into a Calibration Mode

Turn on the ignition and set the display to “Compass/ Temperature.” Press and hold the C/T button for 10 seconds to change the display between VAR (compass variance) and CAL (compass calibration) modes. When the CAL message is displayed complete one or more 360 degree turns in an area free from large metal objects or power lines. The CAL message will turn off and the compass will function normally.

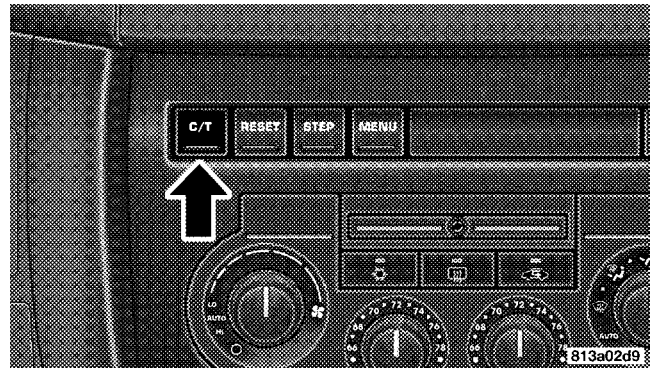

Compass/Temperature Button

Compass Variance is the difference between magnetic north and geographic north. In some areas of the country, the difference between magnetic and geographic north is great enough to cause the compass to give false readings. If this occurs, the compass variance must be set according to the Compass Variance Map.

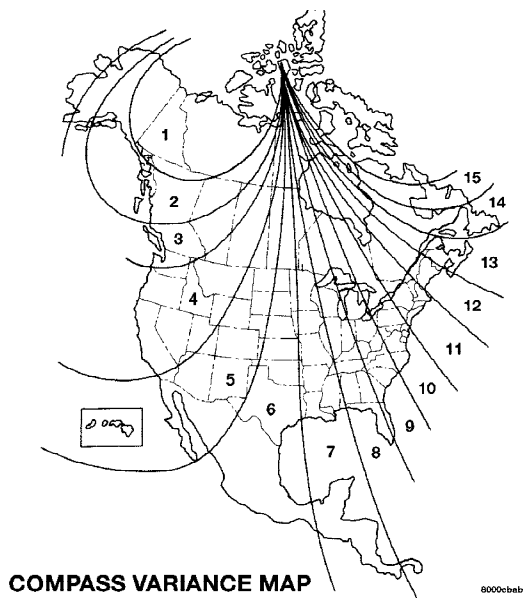

To set the variance: Turn the ignition ON and set the display to "Compass/Temperature." Press the C/T button approximately 5 to 10 seconds. The last variance zone number will be displayed. Press the STEP button to select the new variance zone and press the RESET button to resume normal operation.

RADIO GENERAL INFORMATION

Radio Broadcast Signals

Your new radio will provide excellent reception under most operating conditions. Like any system, however, car radios have performance limitations, due to mobile operation and natural phenomena, which might lead you to believe your sound system is malfunctioning. To help you understand and save you concern about these "apparent" malfunctions, you must understand a point or two about the transmission and reception of radio signals.

Two Types of Signals

There are two basic types of radio signals... AM or Amplitude Modulation, in which the transmitted sound causes the amplitude, or height, of the radio waves to vary... and FM or Frequency Modulation, in which the frequency of the wave is varied to carry the sound.

Electrical Disturbances

Radio waves may pick up electrical disturbances during transmission. They mainly affect the wave amplitude, and thus remain a part of the AM reception. They interfere very little with the frequency variations that carry the FM signal.

AM Reception

AM sound is based on wave amplitude, so AM reception can be disrupted by such things as lightning, power lines and neon signs.

FM Reception

Because FM transmission is based on frequency variations, interference that consists of amplitude variations can be filtered out, leaving the reception relatively clear, which is the major feature of FM radio.

NOTE: On vehicles so equipped the radio, steering wheel radio controls and 6 disc CD/DVD changer will remain active for up to 45 seconds after the ignition switch has been turned off. Opening a vehicle front door will cancel this feature.

SALES CODE RAQ – AM/FM/CD (6-DISC) RADIO WITH OPTIONAL SATELLITE RADIO, HANDS FREE PHONE, AND VEHICLE ENTERTAINMENT SYSTEMS (VES) CAPABILITIES

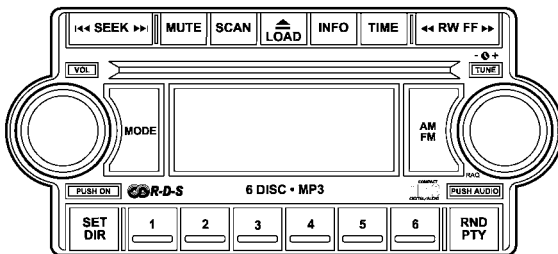

RAQ Radio

81365bb1

Operating Instructions - Radio Mode

NOTE: The ignition switch must be in the ON or ACC position to operate the radio.

Power Switch/Volume Control (Rotary)

Press the ON/VOL control to turn the radio ON. Press the ON/VOL a second time to turn OFF the radio.

Electronic Volume Control

The electronic volume control turns continuously (360 degrees) in either direction without stopping. Turning the volume control to the right increases the volume and to the left decreases it.

When the audio system is turned on, the sound will be set at the same volume level as last played.

For your convenience, the volume can be turned down, but not up, when the audio system is off and the ignition is ON.

Mode Button (Radio Mode)

Press the mode button repeatedly to select between the CD player, Satellite Radio, or Vehicle Entertainment System (VES) (if equipped).

SEEK Button (Radio Mode)

Press and release the SEEK button to search for the next listenable station in either AM/FM or Satellite (if equipped) mode. Press the right side of the button to seek up and the left side to seek down. The radio will remain tuned to the new station until you make another selection. Holding the button will bypass stations without stopping until you release it.

MUTE Button (Radio Mode)

Press the MUTE button to cancel the sound from the speakers. "MUTE" will be displayed. Press the MUTE button a second time and the sound from the speakers

will return. Rotating the volume control, turning the radio ON/OFF, or turning OFF the ignition will also return the sound from the speakers

NOTE: In Hands Free Phone (if equipped) mode, the MUTE button mutes the microphone.

SCAN Button (Radio Mode)

Pressing the SCAN button causes the tuner to search for the next listenable station, in either AM, FM or Satellite (if equipped) frequencies, pausing for 5 seconds at each listenable station before continuing to the next. To stop the search, press SCAN a second time.

MSG or INFO Button (Radio Mode)

Press the MSG or INFO button for an RBDS station (one with call letters displayed). The radio will return a Radio Text message broadcast from an FM station (FM mode only).

Time Button

Press the time button and the time of day will be displayed for 5 seconds.

Clock Setting Procedure

1. Press and hold the time button until the hours blink.
2. Adjust the hours by turning the right side Tune / Audio control.
3. After the hours are adjusted, press the right side Tune / Audio control to set the minutes. The minutes will begin to blink.
4. Adjust the minutes using the right side Tune / Audio control.
5. To exit, press any button/knob or wait 5 seconds.

RW/FF (Radio Mode)

Pressing the rewind/fast forward button causes the tuner to search for the next frequency in the direction of the arrows. This feature operates in either AM, FM or Satellite (if equipped) frequencies.

TUNE Control (Radio Mode)

Turn the right side rotary control clockwise to increase or counter-clockwise to decrease the frequency.

AM/FM Button (Radio Mode)

Press the button to select AM or FM Modes.

Setting the Tone, Balance, and Fade

Press the rotary TUNE control and BASS will display. Turn the TUNE control to the right or left to increase or decrease the Bass tones.

Press the rotary TUNE control a second time and MID will display. Turn the TUNE control to the right or left to increase or decrease the Mid Range tones.

Press the rotary TUNE control a third time and TREBLE will display. Turn the TUNE control to the right or left to increase or decrease the Treble tones.

Press the rotary TUNE control a fourth time and BALANCE will display. Turn the TUNE control to the right or left to adjust the sound level from the right or left side speakers.

Press the rotary TUNE control a fifth time and FADE will display. Turn the TUNE control to the left or right to adjust the sound level between the front and rear speakers.

Press the rotary TUNE control again to exit setting tone, balance and fade.

RND/PTY Button (Radio Mode)

Pressing this button once will turn on the PTY mode for 5 seconds. If no action is taken during the 5 second time out the PTY icon will turn off. Pressing the PTY button or

turning the TUNE rotary knob within 5 seconds will allow the program format type to be selected. Many radio stations do not currently broadcast PTY information.

Toggle the PTY button to select the following format types:

Program Type	16 Digit-Character Display
No program type or undefined	None
Adult Hits	Adult_Hits
Alert Alert	Alert Alert
Classical	Classical
Classic Rock	Classic_Rock
College	College
Country	Country
Emergency Test	Emergency Test
Foreign Language	Foreign_Language
Information	Information
Jazz	Jazz

Program Type	16 Digit-Character Display
News	News
Nostalgia	Nostalgia
Oldies	Oldies
Personality	Personality
Public	Public
Rhythm and Blues	Rhythm_and_Blues
Religious Music	Religious_Music
Religious Talk	Religious_Talk
Rock	Rock
Soft	Soft
Soft Rock	Soft_Rock
Soft Rhythm and Blues	Soft_R_&_B
Sports	Sports
Talk	Talk
Top 40	Top_40
Weather	Weather

By pressing the SEEK button when the PTY icon is displayed, the radio will be tuned to the next frequency station with the same selected PTY name. The PTY function only operates when in the FM mode.

If a preset button is activated while in the PTY (Program Type) mode, the PTY mode will be exited and the radio will tune to the preset station.

SET/DIR Button (Radio Mode) — To Set the Push-Button Memory

When you are receiving a station that you wish to commit to push-button memory, press the SET/DIR button. The symbol SET 1 will now show in the display window. Select the button (1-6) you wish to lock onto this station and press and release that button. If a button is not selected within 5 seconds after pressing the SET/DIR button, the station will continue to play but will not be stored into push-button memory.

You may add a second station to each push-button by repeating the above procedure with this exception: Press the SET/DIR button twice and SET 2 will show in the display window. Each button can be set for SET 1 and SET 2 in both AM and FM. This allows a total of 12 AM, 12 FM and 12 Satellite (if equipped) stations to be stored into push-button memory. The stations stored in SET 2 memory can be selected by pressing the push-button twice.

Every time a preset button is used a corresponding button number will be displayed.

Buttons 1 - 6 (Radio Mode)

These buttons tune the Radio to the stations that you commit to push-button memory {12AM, 12 FM, and 12 Satellite (if equipped) stations}.

Operation Instructions - (CD MODE for CD Audio Play)

NOTE: The ignition switch must be in the ON or ACC position to operate the radio.

NOTE: Note: This Radio is capable of playing compact discs (CD), recordable compact discs (CD-R), rewritable compact discs (CD-RW) compact discs with MP3 tracks and multisession compact discs with CD and MP3 tracks.

Inserting Compact Disc(s)

Gently insert one CD into the CD player with the CD label facing up. The CD will automatically be pulled into the CD Player and the CD icon will illuminate on the radio display.

CAUTION!

This CD player will accept 4 3/4 inch (12 cm) discs only. The use of other sized discs may damage the CD player mechanism.

You may eject a disc with the radio OFF.

If you insert a disc with the ignition ON and the radio ON, the unit will switch from radio to CD mode and begin to play when you insert the disc. The display will show the disc number, the track number, and index time in minutes and seconds. Play will begin at the start of track 1.

SEEK Button (CD MODE for CD Audio Play)

Press the right side of the SEEK button for the next selection on the CD. Press the left side of the button to return to the beginning of the current selection, or return

to the beginning of the previous selection if the CD is within the first 10 seconds of the current selection.

MUTE Button (CD MODE for CD Audio Play)

Press the MUTE button to cancel the sound from the speakers. "MUTE" will be displayed. Press the MUTE button a second time and the sound from the speakers will return. Rotating the volume control, turning the radio ON/OFF, or turning OFF the ignition will also return the sound from the speakers.

SCAN Button (CD MODE for CD Audio Play)

Press the Scan button to scan through each track on the CD currently playing.

LOAD/EJECT Button (CD Mode for CD Audio Play)**LOAD/ EJECT - Load**

Press the LOAD/ EJECT button and the push-button with the corresponding number where the CD is being loaded. The radio will display PLEASE WAIT and prompt when to INSERT DISC. After the radio displays "LOAD DISC" insert the CD into the player.

Radio display will show "LOADING DISC" when the disc is loading, and "READING DISC" when the radio is reading the disc.

LOAD / EJT - Eject

Press the LOAD/ EJT button and the push-button with the corresponding number where the CD was loaded and the disc will unload and move to the entrance for easy removal.

Radio display will show "EJECTING DISC" when the disc is being ejected and prompt the user to remove the disc.

Press and hold the LOAD/ EJT button for 5 seconds and all CDs will be ejected from the radio.

If you have ejected a disc and have not removed it within 15 seconds, it will be reloaded. If the CD is not removed, the radio will continue to play the non-removed CD. If the CD is removed and there are other CD's in the radio, the radio will play the next CD after a 2 minute timeout. If the CD is removed and there are no other CD's in the radio, the radio will remain in CD mode and display "INSERT DISC" for 10 seconds. If no discs are inserted within 10 seconds "NO DISCS LOADED" will be displayed.

The disc can be ejected with the radio and ignition OFF.

TIME Button (CD MODE for CD Audio Play)

Press this button to change the display from a large CD playing time display to a small CD playing time display.

RW/FF (CD MODE for CD Audio Play)

Press and hold FF (Fast Forward) and the CD player will begin to fast forward until FF is released or RW or another CD button is pressed. The RW (Reverse) button works in a similar manner.

TUNE Control (CD MODE for CD Audio Play)

Pressing the TUNE control allows the setting of the Tone, Fade, and Balance. See Radio Mode.

AM/FM Button (CD MODE for CD Audio Play)

Switches the Radio to the Radio mode.

RND/PTY Button (Random Play Button) (CD MODE for CD Audio Play)

Press this button while the CD is playing to activate Random Play. This feature plays the selections on the compact disc in random order to provide an interesting change of pace.

Press the SEEK button to move to the next randomly selected track.

Press and hold the FF button to fast forward through the tracks. Release the FF button to stop the fast forward feature.

Press the RND button a second time to stop Random Play.

Buttons 1 - 6 (CD MODE for CD Audio Play)

Selects disc positions 1 - 6 for Play/Load/Eject.

Notes On Playing MP3 Files

The radio can play MP3 files, however, acceptable MP3 file recording media and formats are limited. When writing MP3 files, pay attention to the following restrictions.

Supported Media (Disc Types)

The MP3 file recording media supported by the radio are CD-ROM, CD-R and CD-RW.

Supported Medium Formats (File Systems)

The medium formats supported by the radio are ISO 9660 Level 1 and Level 2 and includes the Joliet extension. When reading discs recorded using formats other than ISO 9660 Level 1 and Level 2, the radio may fail to read files properly and may be unable to play the file normally. UDF and Apple HFS formats are not supported.

The radio uses the following limits for file systems:

- Maximum number of directory levels: 15
- Maximum number of files: 255
- Maximum number of folders: 100
- Maximum number of characters in file/folder names:
 - Level 1: 12 (including a separator "." and a 3-character extension)
 - Level 2: 31 (including a separator "." and a 3-character extension)

Multisession disc formats are supported by the radio. Multisession discs may contain combinations of normal CD audio tracks and computer files (including MP3 files). Discs created with an option such as "keep disc open after writing" are most likely multisession discs. The use of multisession for CD audio or MP3 playback may result in longer disc loading times.

Supported MP3 File Formats

The radio will recognize only files with the *.mp3 extension as MP3 files. Non-MP3 files named with the *.mp3 extension may cause playback problems. The radio is designed to recognize the file as an invalid MP3 and will not play the file.

When using the MP3 encoder to compress audio data to an MP3 file, the bit rate and sampling frequencies in the following table are supported. In addition, variable bit rates (VBR) are also supported. The majority of MP3 files use a 44.1 kHz sampling rate and a 192, 160, 128, 96 or VBR bit rates.

MPEG Specification	Sampling Frequency (kHz)	Bit rate (kbps)
MPEG-1 Audio Layer 3	48, 44.1, 32	320, 256, 224, 192, 160, 128, 112, 96, 80, 64, 56, 48, 40, 32
MPEG-2 Audio Layer 3	24, 22.05, 16	160, 128, 144, 112, 96, 80, 64, 56, 48, 40, 32, 24, 16, 8

ID3 Tag information for artist, song title and album title are supported for version 1 ID3 tags. ID3 version 2 is not supported by the radios.

Playlist files are not supported. MP3 Pro files are not supported.

Playback of MP3 Files

When a medium containing MP3 data is loaded, the radio checks all files on the medium. If the medium contains a lot of folders or files, the radio will take more time to start playing the MP3 files.

Loading times for playback of MP3 files may be affected by the following:

- Media - CD-RW media may take longer to load than CD-R media
- Medium formats - Multisession discs may take longer to load than non-multisession discs
- Number of files and folders - Loading times will increase with more files and folders

To increase the speed of disc loading, it is recommended to use CD-R media and single-session discs. To create a single-session disc, enable the Disc at Once option before writing to the disc.

Operation Instructions - (CD Mode for MP3 Audio Play)**SEEK Button (CD Mode for MP3 Play)**

Pressing the right side of the SEEK button plays the next MP3 File. Pressing the left side of the SEEK button plays the beginning of the MP3 file. Pressing the button within the first ten seconds plays the previous file.

LOAD/EJECT Button (CD Mode for MP3 Play)**LOAD/ EJECT - Load**

Press the LOAD/ EJECT button and the push-button with the corresponding number where the CD is being loaded. The radio will display PLEASE WAIT and prompt when to INSERT DISC. After the radio displays "LOAD DISC" insert the CD into the player.

Radio display will show "LOADING DISC" when the disc is loading.

LOAD / EJECT - Eject

Press the LOAD/ EJECT button and the push-button with the corresponding number where the CD was loaded and the disc will unload and move to the entrance for easy removal.

Radio display will show "EJECTING DISC" when the disc is being ejected and prompt the user to remove the disc.

If you have ejected a disc and have not removed it within 15 seconds, it will be reloaded. If the CD is not removed, the radio will continue to play the non-removed CD. If the CD is removed and there are other CD's in the radio, the radio will play the next CD after a 2 minute timeout. If the CD is removed and there are no other CD's in the radio, the radio will remain in CD mode and display "INSERT DISC" for 2 minutes. After 2 minutes the radio will go to the previous tuner mode.

MSG or INFO Button (CD Mode for MP3 Play)

Press and MSG or INFO button while playing MP3 disc. The radio scrolls through the following TAG information: Song Title, Artist, File Name, and Folder Name (if available).

Press the MSG or INFO button once more to return to "elapsed time" priority mode.

Press and hold the MSG or INFO button while in the message display priority mode or elapsed time display priority mode will display the song title for each file.

RW/FF (CD Mode for MP3 Play)

Press the FF side of the button to move forward through the MP3 selection.

TUNE Control (CD Mode for MP3 Play)

Pressing the TUNE Control allows the adjustment of Tone, Balance, and Fade.

AM/FM Button (CD Mode for MP3 Play)

Switches back to Radio mode.

RND/ PTY Button (CD Mode for MP3 Play)

Pressing this button plays files randomly.

SET/DIR Button (CD Mode for MP3 Play)

Press the SET/DIR Button to display folders, when playing an MP3 discs that have a file/folder structure. Turn the TUNE control to display available folders or move through available folders. Press the TUNE control to select a folder.

Buttons 1 - 6 (CD Mode for MP3 Play)

Selects disc positions 1 - 6 for Play/Load/Eject.

Operating Instructions - Hands Free Phone (If Equipped)

Refer to Hands Free Phone in Section 3 of the Owner's Manual.

Operating Instructions - Satellite Radio Mode (If Equipped)

Refer to the Satellite Radio section of the Owner's Manual.

Operating Instructions - Video Entertainment System (VES®) (If Equipped)

Refer to separate Video Entertainment System (VES®) Guide.

**SALES CODE REF — AM/FM/CD (SINGLE DISC)
RADIO WITH OPTIONAL SATELLITE RADIO AND
HANDS FREE PHONE CAPABILITY**

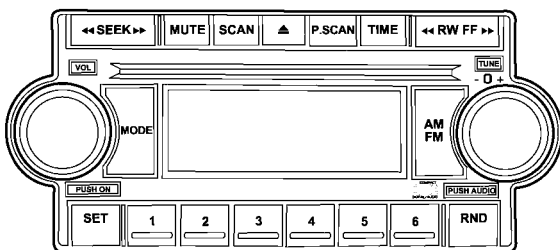

REF Radio

8118787a

Operating Instructions - Radio Mode

NOTE: The ignition switch must be in the ON or ACC position to operate the radio.

Power Switch/Volume Control (Rotary)

Press the ON/VOL control to turn the radio ON. Press the ON/VOL a second time to turn OFF the radio.

Electronic Volume Control

The electronic volume control turns continuously (360 degrees) in either direction without stopping. Turning the volume control to the right increases the volume and to the left decreases it.

When the audio system is turned on, the sound will be set at the same volume level as last played.

For your convenience, the volume can be turned down, but not up, when the audio system is off and the ignition is ON.

Mode Button (Radio Mode)

Press the mode button repeatedly to select between the CD player or Satellite Radio (if equipped).

SEEK Button (Radio Mode)

Press and release the SEEK button to search for the next listenable station in either AM/FM or Satellite (if equipped) mode. Press the right side of the button to seek up and the left side to seek down. The radio will remain tuned to the new station until you make another selection. Holding the button will bypass stations without stopping until you release it.

MUTE Button (Radio Mode)

Press the MUTE button to cancel the sound from the speakers. "MUTE" will be displayed. Press the MUTE button a second time and the sound from the speakers will return. Rotating the volume control, turning the radio ON /OFF, or turning ON/OFF the ignition, will cancel the MUTE feature.

NOTE: In Hands Free Phone (if equipped) mode, the MUTE button mutes the microphone.

SCAN Button (Radio Mode)

Pressing the SCAN button causes the tuner to search for the next listenable station, in either AM, FM or Satellite (if equipped) frequencies, pausing for 5 seconds at each listenable station before continuing to the next. To stop the search, press SCAN a second time.

PSCAN Button (Radio Mode)

Pressing the PSCAN button, causes the tuner to scan through preset stations, in either AM, FM or Satellite (if equipped) frequencies, pausing for 5 seconds at each preset station before continuing to the next. To stop the search, press PSCAN a second time.

Time Button

Press the time button and the time of day will be displayed for 5 seconds.

Clock Setting Procedure

1. Press and hold the time button until the hours blink.
2. Adjust the hours by turning the right side Tune / Audio control.
3. After the hours are adjusted, press the right side Tune / Audio control to set the minutes. The minutes will begin to blink.
4. Adjust the minutes using the right side Tune / Audio control.
5. To exit, press any button/knob or wait 5 seconds.

RW/FF (Radio Mode)

Pressing the rewind/fast forward button causes the tuner to search for the next frequency in the direction of the arrows. This feature operates in either AM, FM or Satellite (if equipped) frequencies.

TUNE Control (Radio Mode)

Turn the right side rotary control clockwise to increase or counter-clockwise to decrease the frequency.

AM/FM Button (Radio Mode)

Press the button to select AM or FM Modes.

Setting the Tone, Balance, and Fade

Press the rotary TUNE control and BASS will be displayed. Turn the TUNE control to the right or left to increase or decrease the Bass tones.

Press the rotary TUNE control a second time and MID will be displayed. Turn the TUNE control to the right or left to increase or decrease the Mid Range tones.

Press the rotary TUNE control a third time and TREB will be displayed. Turn the TUNE control to the right or left to increase or decrease the Treble tones.

Press the rotary TUNE control a fourth time and BAL will be displayed. Turn the TUNE control to the right or left to adjust the sound level from the right or left side speakers.

Press the rotary TUNE control a fifth time and FADE will be displayed. Turn the TUNE control to the left or right to adjust the sound level between the front and rear speakers.

Press the tune control again or wait 5 seconds to exit setting tone, balance, and fade.

SET Button (Radio Mode) To SET The Push-Button Memory

When you are receiving a station that you wish to commit to push-button memory, press the SET button. The symbol SET 1 will now show in the display window. Select the button (1-6) you wish to lock onto this station and press and release that button. If a button is not

selected within 5 seconds after pressing the SET button, the station will continue to play but will not be stored into push-button memory.

You may add a second station to each push-button by repeating the above procedure with this exception: Press the SET button twice and SET 2 will show in the display window. Each button can be set for SET 1 and SET 2 in both AM and FM. This allows a total of 12 AM, 12 FM and 12 Satellite (if equipped) stations to be stored into push-button memory. The stations stored in SET 2 memory can be selected by pressing the push-button twice.

Every time a preset button is used a corresponding button number will be displayed.

Preset Buttons 1 - 6 (Radio Mode)

These buttons tune the Radio to the stations that you commit to push-button memory {12 AM, 12 FM, and 12 Satellite (if equipped) stations}.

Operation Instructions - CD Mode

NOTE: The ignition switch must be in the ON or ACC position to operate the radio.

Inserting The Compact Disc (Single CD Player)

Gently insert one CD into the CD player with the CD label facing up. The CD will automatically be pulled into the CD Player and the CD icon will illuminate on the radio display.

If the volume control is ON, the unit will switch to CD mode and begin to play. The display will show the track number and play time in minutes and seconds. Play will begin at the start of track one.

NOTE:

- You may insert or eject a disc with the radio or ignition switch OFF.

- If you insert a disc with the ignition ON and the radio OFF, the CD will automatically be pulled into the CD Player.
- This radio does not play discs with MP3 tracks.

SEEK Button (CD Mode)

Press the right side of the SEEK button for the next track on the CD. Press the left side of the button to return to the beginning of the current track, or return to the beginning of the previous track if the CD is within the first 10 seconds of the current selection.

MUTE Button ((CD Mode)

Press the MUTE button to cancel the sound from the speakers. "MUTE" will be displayed. Press the MUTE button a second time and the sound from the speakers will return. Rotating the volume control or turning OFF the ignition will also return the sound from the speakers.

SCAN Button (CD Mode)

Press this button to play the first 10 seconds of each track. To stop the scan function, press the button a second time.

EJECT Button (CD Mode)

Press this button and the disc will unload and move to the entrance for easy removal. The unit will switch to the last selected mode.

If you do not remove the disc within 15 seconds, it will be reloaded. The radio mode will continue to appear.

TIME Button (CD Mode)

Press this button to change the display from elapsed CD playing time to time of day. The time of day will be displayed for 5 seconds.

RW/FF (CD Mode)

Press and hold the FF (Fast Forward) and the CD player will begin to fast forward until FF is released. The RW (Reverse) button works in a similar manner.

NOTE: RND Button (Random Play Button) (CD Mode)

Press this button while the CD is playing to activate Random Play. This feature plays the selections on the compact disc in random order to provide an interesting change of pace.

Press the SEEK button to move to the next randomly selected track.

Press and hold the FF button to fast forward through the tracks. Release the FF button to stop the fast forward feature. If the RW button is pressed, the current track will reverse to the beginning of the track and begin playing.

Press the RND button a second time to stop Random Play.

Operating Instructions - Hands Free Phone — If Equipped

Refer to the HANDS FREE PHONE (UConnect™) section of the Owner's Manual.

Operating Instructions - Satellite Radio — If Equipped

Refer to the Satellite Radio section of the Owner's Manual.

SALES CODE REC — AM/FM/CD (6-DISC) RADIO WITH NAVIGATION SYSTEM

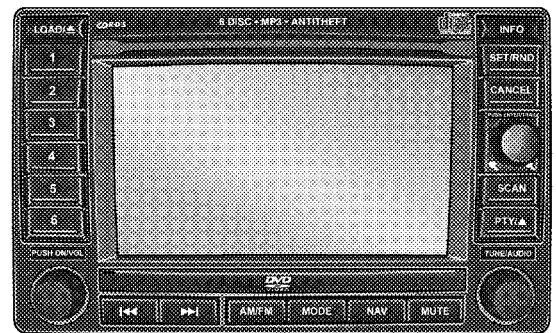

8125e256

REC Radio

Satellite Navigation Radio with CD Player with MP3 Capability (REC) - combines a Global-Positioning System-based navigation system with an integrated color screen to provide maps, turn identification, selection

menus and instructions for selecting a variety of destinations and routes, Am/FM stereo radio and six-disc CD changer with MP3 capability.

Mapping information for navigation is supplied on a DVD that is loaded into the unit. One map DVD covers all of North America. Refer to your "Navigation User's Manual" for detailed operating instructions.

SATELLITE RADIO — IF EQUIPPED

Satellite radio uses direct satellite to receiver broadcasting technology to provide clear digital sound, coast to coast. The subscription service provider is Sirius™ Satellite Radio. This service offers up to 100 channels of music, sports, news, entertainment, and programming for children, directly from its satellites and broadcasting studios.

System Activation

To activate your Sirius Satellite Radio service, call the toll-free number 888-539-7474, or visit the Sirius web site at www.sirius.com. Please have the following information available when activating your system:

1. The Electronic Serial Number/Sirius Identification Number (ESN/SID).
2. Credit card information.
3. Your Vehicle Identification Number.

Electronic Serial Number/Sirius Identification Number (ESN/SID)

The Electronic Serial Number/Sirius Identification Number is needed to activate your Sirius Satellite Radio system. To access the ESN/SID, refer to the following steps:

ESN/SID Access With REF Radios

With the ignition switch in the ACCESSORY position and the radio OFF, press the Eject or CD Eject (depending on the radio type) and Time buttons simultaneously for 3 seconds. The first four digits of the twelve-digit ESN/SID number will be displayed. Press the SEEK UP button to display the next four digits. Continue to press the SEEK UP button until all twelve ESN/SID digits have been displayed. The SEEK DOWN will page down until the first four digits are displayed. The radio will exit the ESN/SID mode when any other button is pushed, the ignition is turned OFF, or 5 minutes has passed since any button was pushed.

ESN/SID Access With RAQ Radios

With the ignition switch in the ACCESSORY position and the radio OFF, press the CD Eject and TIME buttons simultaneously for 3 seconds. All twelve ESN/SID numbers will be displayed. The radio will exit the ESN/SID

mode when any other button is pushed, the ignition is turned OFF, or 5 minutes has passed since any button was pushed.

Selecting Satellite Mode in REF Radios

Press the MODE button repeatedly until "S A" appears in the display. A CD may remain in the radio while in the Satellite radio mode.

Selecting Satellite Mode in RAQ Radios

Press the MODE button repeatedly until the word "SIRIUS" appears in the display. These radios will also display the following:

- After 3 seconds, the current channel name and channel number will be displayed for 5 seconds.
- The current program type and channel number will then be displayed for 5 seconds.
- The current channel number will then be displayed until an action occurs.

A CD may remain in the radio while in the Satellite radio mode.

Selecting a Channel

Press and release the SEEK or TUNE buttons to search for the next channel. Press the top of the button to search up and the bottom of the button to search down. Holding the TUNE button causes the radio to bypass channels until the button is released.

Press and release the SCAN button (if equipped) to automatically change channels every 7 seconds. The radio will pause on each channel for 7 seconds before moving on to the next channel. The word "SCAN" will appear in the display between each channel change. Press the SCAN button a second time to stop the search.

NOTE: Channels that may contain objectionable content can be blocked. Contact Sirius Customer Care at 888-539-7474 to discuss options for channel blocking or unblocking. Please have your ESN/SID information available.

Storing and Selecting Pre-Set Channels

In addition to the 10 AM and 10 FM pre-set stations, you may also commit 10 satellite stations to push button memory. These satellite channel pre-set stations will not erase any AM or FM pre-set memory stations. Follow the memory pre-set procedures that apply to your radio.

Using the PTY (Program Type) Button (if equipped)

Follow the PTY button instructions that apply to your radio.

PTY Button "SCAN"

When the desired program type is obtained, press the "SCAN" button within five seconds. The radio will play 7 seconds of the selected channel before moving to the next channel of the selected program type. Press the "SCAN" button a second time to stop the search.

NOTE: Pressing the "SEEK" or "SCAN" button while performing a music type scan will change the channel by

one and stop the search. Pressing a pre-set memory button during a music type scan, will call up the memory channel and stop the search.

PTY Button "SEEK"

When the desired program is obtained, press the "SEEK" button within five seconds. The channel will change to the next channel that matches the program type selected.

Satellite Antenna

To ensure optimum reception on vehicles available with a luggage rack, do not place items on the roof around the rooftop antenna location. Metal objects placed within the line of sight of the antenna will cause decreased performance. Larger luggage items should be placed as far forward as possible. Do not place items directly on or above the antenna.

Reception Quality

Satellite reception may be interrupted due to one of the following reasons.

- The vehicle is parked in an underground parking structure or under a physical obstacle.
- Dense tree coverage may interrupt reception.
- Driving under wide bridges or along tall buildings can cause intermittent reception.
- Placing objects over or too close to the antenna can cause signal blockage.

REMOTE SOUND SYSTEM CONTROLS — IF EQUIPPED

The remote sound system controls are located on the rear surface of the steering wheel. Reach behind the wheel to access the switches.

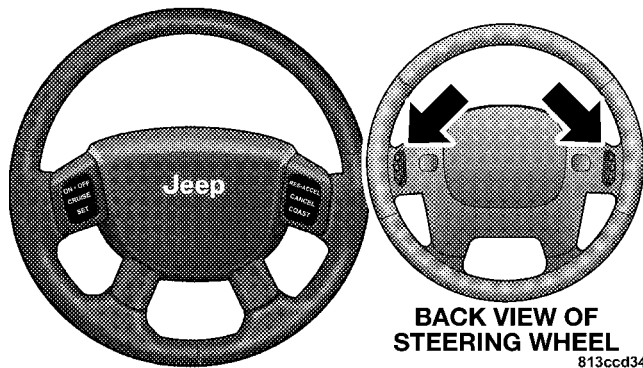

The right hand control is a rocker type switch with a push-button in the center and controls the volume and mode of the sound system. Pressing the top of the rocker

switch will increase the volume and pressing the bottom of the rocker switch will decrease the volume.

Pressing the center button will make the radio switch between the various modes available (AM/FM/TAPE/CD, Etc.).

The left hand control is a rocker type switch with a push-button in the center. The function of the left hand control is different depending on which mode you are in.

The following describes the left hand control operation in each mode.

Radio Operation

Pressing the top of the switch will "Seek" up for the next listenable station and pressing the bottom of the switch will "Seek" down for the next listenable station.

The button located in the center of the left hand control will tune to the next preset station that you have programmed in the radio preset push-button.

CD Player

Pressing the top of the switch once will go to the next track on the CD. Pressing the bottom of the switch once will go to the beginning of the current track or to the beginning of the previous track if it is within one second after the current track begins to play.

If you press the switch up or down twice it plays the second track, three times, it will play the third, etc.

The center button on the left side rocker switch has no function for a single disc CD player. However, when a multiple disc CD player is equipped on the vehicle, the center button will select the next available CD in the player.

CD/DVD DISC MAINTENANCE

To keep the CD/DVD discs in good condition, take the following precautions:

1. Handle the disc by its edge; avoid touching the surface.
2. If the disc is stained, clean the surface with a soft cloth, wiping from center to edge.
3. Do not apply paper, paper CD labels, or tape to the disc; avoid scratching the disc.
4. Do not use solvents such as benzine, thinner, cleaners, or antistatic sprays.
5. Store the disc in its case after playing.
6. Do not expose the disc to direct sunlight.
7. Do not store the disc where temperatures may become too high.

RADIO OPERATION AND CELLULAR PHONES

Under certain conditions, the cellular phone being On in your vehicle can cause erratic or noisy performance from your radio. This condition may be lessened or eliminated by relocating the cellular phone antenna. This condition is not harmful to the radio. If your radio performance does not satisfactorily “clear” by the repositioning of the antenna, it is recommended that the radio volume be turned down or off during cellular phone operation.

CLIMATE CONTROLS

Climate Controls — Manual

Air Conditioning

The controls for the heating/air conditioning and ventilation system in this vehicle consist of a series of rotary knobs. These comfort controls can be set to obtain desired interior conditions.

The instrument panel features four dual-vane airflow registers. Two registers are located on the outer ends of the instrument panel and two are located in the center of the instrument panel. These registers can be closed to partially block airflow.

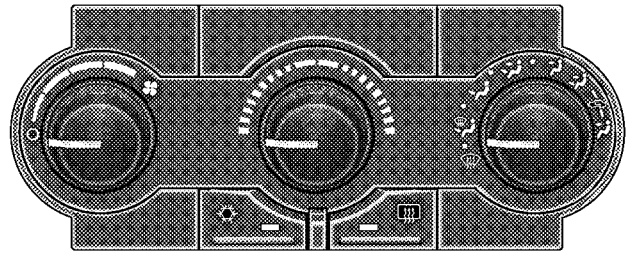

81350206

Manual Air Conditioning and Heating Controls



Press this button to turn on and off the air conditioning. Cool dehumidified air comes through the outlets selected by the mode selector. Press the button a second time to turn off the air conditioning. The button includes an LED that illuminates when compressor operation is selected.

Electric Rear Window Defroster



Press this button to turn on the rear window defroster and the heated side mirrors (if equipped). An LED in the button will illuminate to indicate the rear window defroster is ON. The defroster automatically turns off after about 10 minutes of operation.

CAUTION!

To avoid damaging the electrical conductors of the rear window defroster, do not use scrapers, sharp instruments, or abrasive window cleaners on the interior surface of the window.

Labels can be peeled off after soaking with warm water.

Blower Control



812d1942

The rotary knob on the left controls the blower and can be set in one of four speeds and OFF. **The blower fan motor will remain on until the system is turned to the OFF position or the ignition is turned OFF.**

Temperature Control

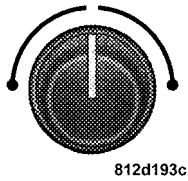

The temperature of air can be selected by rotating the temperature control knob in the center. The coldest temperature setting is on the extreme left and the warmest setting on the extreme right of the rotation. The knob can be positioned at any point on the

dial.

Mode Selection



The mode selector (the right rotary knob) can be placed in several positions. Dots between each of the mode selections identify intermediate modes that allow the occupants to fine tune airflow distribution.

Defrost



Air is directed to the windshield through the outlets at the base of the windshield. Air is also directed to the front door windows through the side window demister grilles.

NOTE: To improve fuel economy, leave in defrost only when necessary.

Defrost/Floor



Air flows through the front and rear floor outlets and the outlets at the base of the windshield. Air is also directed to the front door windows through the side window demister grilles.

Floor



Air flows through the floor outlets located under the instrument panel and into the rear seating area through vents under the front seats.

Bi-Level

 Air flows both through the outlets located in the instrument panel and those located on the floor. Air flows through the registers in the back of the center console to the rear seat passengers. These registers can be closed to partially block airflow.

Panel

 Air flows through the outlets located in the instrument panel. Air flows through the registers in the back of the center console to the rear seat passengers. These registers can be closed to block airflow.

Recirculation

 The recirculation feature can be selected with the mode control knob. You may choose between Bi-Level Recirculation and Panel Recirculation air outlets while in this mode. Normally, air enters from outside the vehicle. However, when in Recirculation mode air inside the vehicle is re-used.

















Use this mode to rapidly cool the inside of the vehicle. The Recirculation mode can also be used to temporarily block out outside odors, smoke, and dust.

Window Fogging

Interior fogging on the windshield can be quickly removed by turning the mode selector to Defrost. The Defrost/Floor mode can be used to maintain a clear windshield and provide sufficient heating. If side window fogging becomes a problem increase blower speed. Vehicle windows tend to fog on the inside in mild but rainy or humid weather.

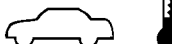
NOTE: Recirculate without A/C should not be used for long periods as fogging may occur.

Operating Tips

WEATHER	CONTROL SETTINGS
<p>HOT WEATHER AND VEHICLE INTERIOR IS VERY HOT</p> 	<p>Open the windows, start the vehicle, set the Mode control to Panel  or Bi-Level , and turn on A/C. Set the Fan control to the High position (full clockwise). Set the temperature control to full cool. After the hot air is flushed from the vehicle, set the Mode control to Recirculate  with A/C on and roll up the windows. Once you are comfortable, set the Mode control to Panel  or Bi-Level  with A/C on.</p>
<p>WARM WEATHER</p> 	<p>If it's sunny, set the Mode control to Panel  and turn on A/C. If it's cloudy or dark, set the Mode control to Bi-Level  with A/C on. Adjust Temperature control for comfort.</p>
<p>COOL OR COLD HUMID CONDITIONS</p> 	<p>Set the Mode control to Defrost/Floor  or Defrost . Set the Fan Control to the High position (full clockwise). Adjust Fan and Temperature control for comfort if windows are clear.</p>
<p>COLD DRY CONDITIONS</p> 	<p>Set the Mode control to Floor . If it's sunny, you may want more upper air. In this case, set the Mode control to Bi-Level . In very cold weather, if you need extra heat at the windshield, set the Mode control to Defrost/Floor  or Defrost  as needed. Adjust Fan and Temperature control for comfort.</p>

81352266

Automatic Temperature Control — If Equipped

The Infrared Dual-Zone Climate Control System automatically maintains the interior comfort level desired by the driver and passenger. This is accomplished by a dual sun-sensor in the top of the instrument panel, and an infrared sensor located in the face of the control unit. There are also various sensors monitored by this system which take account for vehicle speed, A/C pressure, outside temperature, and engine cooling temperature. The infrared sensor independently measures the surface temperature of the driver and passenger. Based on the sensor input, the system automatically adjusts the air flow temperature, the air flow volume, and amount of outside air recirculation. This maintains a comfortable temperature even under changing conditions.

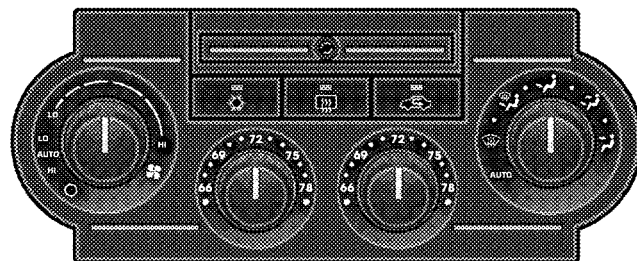

8135020a

Automatic Temperature Controls

Operation of the system is quite simple. Begin by turning the right mode knob to AUTO, and place the blower control (left knob) to either LO AUTO or HI AUTO. The LO AUTO position should be used for front seat occupants only. The HI AUTO position should be used when more air flow is desired, or when rear seat occupants are

present. Dial in the temperature you would like the system to maintain by rotating the driver's or passenger's control knob. Once the comfort level is selected the system will maintain that level automatically using the heating system. Should the desired comfort level require air conditioning, the system will automatically make the adjustment.

You will experience the greatest efficiency by simply allowing the system to function automatically. Selecting the OFF position on the fan control stops the system completely and closes the outside air intake.

NOTE: The temperature setting can be adjusted at any time without affecting automatic control operation.



The air conditioning in this system is automatic. Pressing this button while in AUTO mode will cause the LED to flash three times and remain off. This indicates that the system is in AUTO and requesting the air conditioning is not necessary.



The system will automatically control recirculation. However, pressing this button will temporarily put the system in recirculation mode (ten minutes). This can be used when outside conditions such as smoke, odors, dust, or high humidity are present. This will cause the LED to illuminate. After ten minutes the system will return to normal AUTO mode function and the LED will turn off.

NOTE:

- The surface of the climate control panel, and the top center of the instrument panel should be kept free of debris due to the climate control sensor's location. Mud on the windshield may also cause poor operation of this system.
- To provide you with maximum comfort in the automatic mode, during cold start-ups the blower fan will remain off until the engine warms up. However, the

fan will engage immediately if the defrost mode is selected or if you manually select a blower speed.

- Under certain conditions (after the vehicle is turned off) the climate control system may recalibrate and a noise may be heard for 20 seconds. This is part of normal operation.
- Most of the time, when in Automatic operation, you can temporarily put the system into recirculation mode by pressing the Recirc button. However, under certain conditions in automatic the system is blowing air out of the defrost vents. When these conditions are present and the Recirc button is pressed the indicator will flash and remain off. This tells you that you are unable to go into recirculation mode at this time. If you would like to go to Recirculation mode, you must first

move your mode knob to panel, panel/floor or floor, then hit the recirc button. This feature will reduce the possibility of window fogging.

Manual Operation

This system offers a full complement of manual override features which consist of Blower Preferred Automatic, Mode Preferred Automatic, or Blower and Mode Preferred Automatic. This means the customer can override the blower, the mode, or both. There is a manual blower range used when the AUTO setting is not desired. The left control can be set to any fixed blower speed by rotating the knob.

NOTE: Please read the Automatic Temperature Control Operation Chart below for details.

Automatic Temperature Control Operation		The system will...				
Operation	How	Blower Control	Mode Control	Air Temperature Control	Air Recirculation Control	A/C Operation
Full Automatic Operation	Set blower knob to either Hi or Lo Auto. Set mode knob to Auto. Set temperature knobs for comfort.	Automatic	Automatic	Automatic	Automatic but can be overridden.	Automatic
Blower Preferred Automatic	Set blower knob to any desired airflow level other than Hi or Lo Auto. Set mode knob to Auto. Set temperature knobs for comfort.	User selectable to any speed.	Automatic	Automatic	Automatic but can be overridden.	Automatic
Mode Preferred Automatic	Set mode knob to any desired air delivery point other than Auto. Set blower knob to either Hi or Lo Auto. Set temperature knobs for comfort.	Automatic	User selectable to any air delivery point.	Automatic	User selectable outside or recirculated.	User selectable A/C on or off.
Blower and Mode Preferred Automatic	Set blower knob to any desired airflow level other than Hi or Lo Auto. Set mode knob to any desired air delivery point other than Auto. Set temperature knobs for comfort.	User selectable to any speed.	User selectable to any air delivery point.	Automatic	User selectable outside or recirculated.	User selectable A/C on or off.

The operator can override the AUTO mode setting and select the direction of the air by rotating the right mode knob to one of the following positions.

- *Defrost*



Air is directed to the windshield through the outlets at the base of the windshield. Air is also directed to the front door windows through the side window demister grilles.

- *Defrost/Floor*



Air flows through the front and rear floor outlets and the outlets at the base of the windshield. Air is also directed to the front door windows through the side window demister grilles.

- *Floor*



Air flows through the floor outlets located under the instrument panel and into the rear seating area through vents under the front seats.

- *Bi-Level*



Air flows both through the outlets located in the instrument panel and those located on the floor. Air flows through the registers in the back of the center console to the rear seat passengers. These registers can be closed to block airflow.

- *Panel*



Air flows through the outlets located in the instrument panel. Air flows through the registers in the back of the center console to the rear seat passengers. These registers can be closed to block airflow.



Depress this button to turn on and off the air conditioning during manual operation only. Conditioned outside air is then directed through the outlets selected on the mode control dial. The button includes an LED that illuminates when manual operation is selected.

NOTE: To manually control the air conditioning the mode selector must be moved out of the AUTO position.



Press this button to turn on the rear window defroster and the heated side mirrors (if equipped). An LED in the button will illuminate indicating that the rear window defroster is ON. The defroster automatically turns off after approximately 10 minutes of operation for the first push of the button, and will turn off after approximately 5 minutes for the second push of the button.

CAUTION!

To avoid damaging the electrical conductors of the rear window defroster, do not use scrapers, sharp instruments, or abrasive window cleaners on the interior surface of the window.

Labels can be peeled off after soaking with warm water.

4



This button can be used to block out smoke, odors, dust, high humidity, or if rapid cooling is desired. The recirculation mode should only be used temporarily. The button includes an LED that illuminates, which indicates that the recirculation mode is active. You may use this feature separately.

NOTE: Extended use of recirculation may cause the windows to fog. If the interior of the windows begins to fog, press the “Recirculate” icon button to return to outside air. Some temp./humidity conditions will cause captured interior air to condense on windows and hamper visibility. For this reason, the system will not allow “Recirculate” to be selected while in the defrost or defrost/floor modes. Attempting to use the recirculation while in these modes will cause the LED in the button to blink and then turn off.

Summer Operation

The engine cooling system in air conditioned vehicles must be protected with a high-quality antifreeze coolant to provide proper corrosion protection and to protect against engine overheating. A 50% solution of ethylene glycol antifreeze coolant in water is recommended. Refer to “Maintenance Procedures” in Section 7 of this manual for proper coolant selection.

Winter Operation

Use of the air Recirculation mode during winter months is not recommended because it may cause window fogging.

NOTE: Refer to the “Operating Tips” chart (for Manual A/C Control) in this section for suggested control settings in different weather conditions.

Vacation Storage

Anytime you store your vehicle, or keep it out of service (i.e. vacation) for two weeks or more, run the air conditioning system at idle for about five minutes in the fresh air and high blower setting. This will insure adequate system lubrication to minimize the possibility of compressor damage when the system is started again.

Window Fogging

Interior fogging on the windshield can be quickly removed by turning the mode selector to Defrost. The Defrost/Floor mode can be used to maintain a clear windshield and provide sufficient heating. If side window fogging becomes a problem increase blower speed. Vehicle windows tend to fog on the inside in mild but rainy or humid weather.

NOTE: Recirculate without A/C should not be used for long periods as fogging may occur.

Outside Air Intake

Make sure the air intake, located directly in front of the windshield, is free of obstructions such as leaves. Leaves collected in the air intake may reduce airflow and if they enter the plenum they could plug the water drains. In winter months make sure the air intake is clear of ice, slush and snow.

STARTING AND OPERATING

CONTENTS

■ Starting Procedures	230	□ Rocking The Vehicle	238
□ Normal Starting	230	■ Four-Wheel Drive Operation	239
□ Extreme Cold Weather (Below -20°F (-29°C)	231	□ Quadra-Trac I® Operating Instructions/Precautions — If Equipped	239
□ If Engine Fails To Start	231	□ Quadra-Trac II® Operating Instructions/Precautions — If Equipped	240
□ After Starting	232	□ Shift Positions	241
■ Engine Block Heater — If Equipped	232	□ Shifting Procedures	242
■ Transmission Shifting	233	□ Quadra-Drive® System — If Equipped	244
□ 5-Speed Automatic Transmission	233	■ Parking Brake	244
□ Gear Ranges	234		

228 STARTING AND OPERATING

■ Anti-Lock Brake System	246	□ Tire Markings	254
■ Vari-Lok Rear Axle — If Equipped	249	□ Tire Identification Number (TIN)	258
■ On-Road Driving Tips	249	□ Tire Loading And Tire Pressure	259
■ Off-Road Driving Tips	250	■ Tires — General Information	263
□ When To Use 4WD Low Range — If Equipped	250	□ Tire Inflation Pressures	264
□ Driving Through Water	250	□ High Speed Operation	265
□ Driving In Snow, Mud And Sand	251	□ Radial-Ply Tires	266
□ Hill Climbing	251	□ Tire Spinning	266
□ Traction Downhill	252	□ Tread Wear Indicators	267
□ After Driving Off-Road	253	□ Replacement Tires	267
■ Multi Displacement System (MDS) - 5.7L Engine Only	254	□ Alignment And Balance	268
■ Tire Safety Information	254	■ Tire Pressure Monitor System	269
		□ Tire Pressure Monitoring — Base System	269

□ Tire Pressure Monitoring — Premium System . . .271	□ Loose Fuel Filler Cap Message282
□ General Information275	■ Trailer Towing283
■ Tire Chains275	□ Trailer And Tongue Weight285
■ Tire Rotation Recommendations276	□ Trailer Tow Wiring286
■ Fuel Requirements277	□ Cooling System Tips—Trailer Towing287
□ 3.7/4.7L Engines (If Equipped)277	□ Trailer Classifications288
□ 5.7L Engines (If Equipped)277	□ Trailer Towing Capability289
□ Reformulated Gasoline278	■ Recreational Towing (Behind Motorhome, Etc.) . .290
□ Gasoline/Oxygenate Blends278	□ Towing – 2WD Models290
□ MMT In Gasoline279	□ Towing — Quadra-Trac I (Single-Speed Transfer Case) 4WD Models290
□ Materials Added To Fuel279	□ Towing — Quadra-Trac II /Quadra-Drive II 4WD Models290
□ Fuel System Cautions279	■ Snow Plow293
□ Carbon Monoxide Warnings280	
■ Fuel Tank Filler Cap (Gas Cap)281	

STARTING PROCEDURES

Before starting your vehicle, adjust your seat, adjust both inside and outside mirrors, and fasten your seat belts.

WARNING!
Do not leave children or animals inside parked vehicles in hot weather. Interior heat build up may cause serious injury or death.

The gear selector must be in the N (Neutral) or P (Park) position before you can start the engine. Apply the brakes before shifting to any driving gear.

Normal Starting

Normal starting of either a cold or a warm engine is obtained without pumping or depressing the accelerator pedal. Turn the key to the START position and release when the engine starts. If the engine fails to start within

10 seconds, turn the key to the OFF position, wait 5 seconds, then repeat the normal starting procedure.

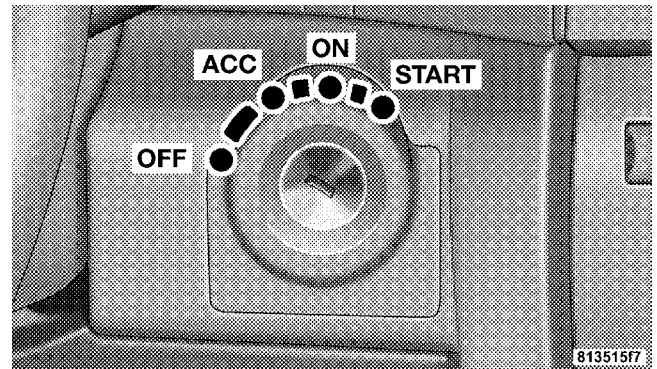

Ignition Key Positions

WARNING!

Never pour fuel or other flammable liquids into the throttle body air inlet opening in an attempt to start the vehicle. This could result in a flash fire causing serious personal injury.

Extreme Cold Weather (below –20°F (–29°C))

To insure reliable starting at these temperatures, use of an externally powered electric engine block heater (available from your authorized dealer) is recommended.

If Engine Fails to Start

If the engine fails to start after you have followed the “Normal Starting” or “Extreme Cold Weather” procedures, it may be flooded. Push the accelerator pedal all the way to the floor and hold it there while cranking the engine. This should clear any excess fuel in case the engine is flooded.

NOTE: To prevent damage to the starter, do not crank the engine for more than 15 seconds at a time. Wait 10 to 15 seconds before trying again.

If the engine has been flooded, it may start to run, but not have enough power to continue running when the key is released. If this occurs, continue cranking with the accelerator pedal pushed all the way to the floor. Release the accelerator pedal and the key once the engine is running smoothly.

If the engine shows no sign of starting after two 15-second periods of cranking with the accelerator pedal held to the floor, the “Normal Starting” or “Extreme Cold Weather” procedures should be repeated.

After Starting

The idle speed will automatically decrease as the engine warms up.

CAUTION!

Long periods of engine idling, especially at high engine speeds can cause excessive exhaust temperatures which can damage your vehicle. Do not leave your vehicle unattended with the engine running.

ENGINE BLOCK HEATER — IF EQUIPPED

The engine block heater warms engine coolant and permits quicker starts in cold weather. Connect the cord to a standard 110-115 volt AC electrical outlet with grounded, three wire extension cord.

Use the heater when temperatures below 0°F (-18°C) are expected to last for several days.

The engine block heater cord is located:

- 3.7L/4.7L Engine — coiled and strapped to the engine oil dipstick tube.
- 5.7L Engine — bundled and fastened to the injector harness.

WARNING!

Remember to disconnect the cord before driving. Damage to the 110-115 volt AC electrical cord could cause electrocution.

TRANSMISSION SHIFTING

5-Speed Automatic Transmission

The electronically controlled transmission provides a precise shift schedule. The transmission electronics are self-calibrating; therefore, the first few shifts on a new vehicle, may be somewhat abrupt. This is a normal condition, and precision shifts will develop within a few hundred miles.

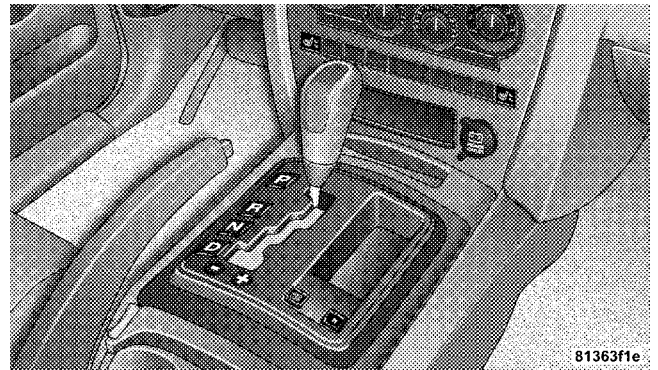

Automatic Shift Controls

WARNING!

It is dangerous to shift the selector lever out of P (Park) or N (Neutral) if the engine speed is higher than idle speed. If your foot is not firmly on the brake pedal, the vehicle could accelerate quickly forward or in reverse. You could lose control of the vehicle and hit someone or something. Only shift into gear when the engine is idling normally and when your foot is firmly on the brake pedal.

Brake Transmission Shift Interlock System

This vehicle is equipped with a brake transmission shift interlock system (BTSI) that holds the gearshift lever in the P (Park) position when the ignition switch is in the LOCK position. To move the gear selector lever out of the P (Park) position, the ignition switch must be turned to the ON position, and the brake pedal must be depressed.

Gear Ranges**P (Park)**

Supplements the parking brake by locking the transmission. The engine can be started in this range. Never use P (Park) while the vehicle is in motion. Apply the parking brake when leaving the vehicle in this range.

WARNING!

Unintended movement of a vehicle could injure those in and near the vehicle. As with all vehicles, you should never exit a vehicle while the engine is running. Before exiting a vehicle, you should apply the park brake, shift the transmission into P (Park), and remove the key from the ignition. Once the key is removed from the ignition the transmission shift lever is locked in the P (Park) position, securing the vehicle against unwanted movement. Furthermore, you should never leave children unattended inside a vehicle.

R (Reverse)

Shift into this range only after the vehicle has come to a complete stop.

N (Neutral)

No power is transmitted from the engine to the drive axle. When the brakes are released, the vehicle can roll freely. Do not engage in N (Neutral) position while driving except to coast when the vehicle is in danger of skidding (e.g., on icy roads).

NOTE: Towing the vehicle, coasting, or driving for any other reason with selector lever in N (Neutral) can result in severe transmission damage. Refer to “Recreational Towing” in Section 5 and “Towing a Disabled Vehicle” in Section 6 of this manual.

D (Drive)

The transmission automatically upshifts through fifth gear. The D (Drive) position provides optimum driving characteristics under all normal operating conditions.

Electronic Range Select (ERS) Operation

The Electronic Range Select (ERS) shift control allows you to move the shifter left (-) or right (+) when the shifter is in the D (Drive) position, allowing the selection of the desired top gear. For example, if the driver shifts the transmission into 3 (third gear), the transmission will never shift above third gear, but can shift down to 2 (second) or 1 (first), when needed.

WARNING!

Do not downshift for additional engine braking on a slippery surface. The drive wheels could lose their grip and the vehicle could skid.

Screen Display	1	2	3	4	D
Actual Gear(s) Allowed	1	1-2	1-3	1-4	1-5

NOTE: To select the proper gear position for maximum deceleration (engine braking), move the shift lever to the

left “D(-)” and hold it there. The transmission will shift to the range from which the vehicle can best be slowed down.

Overdrive Operation

The overdrive automatic transmission contains an electronically controlled fourth and fifth speed (Overdrive). The transmission will automatically shift from 3rd gear to Overdrive if the following conditions are present:

- the transmission selector is in D (Drive);
- the engine coolant has reached normal operating temperature;
- vehicle speed is above approximately 30 mph (48 km/h);
- the “TOW/HAUL” button has not been activated;
- transmission has reached normal operating temperature.

NOTE: If the vehicle is started in extremely cold temperatures, the transmission may not shift into Overdrive and will automatically select the most desirable gear for operation at this temperature. Normal operation will resume when the transmission fluid temperature has risen to a suitable level. Refer also to the Note under torque converter clutch, later in this section.

If the transmission temperature gets extremely hot, the transmission will automatically select the most desirable gear for operation at this temperature. If the transmission temperature becomes hot enough, the “TRANSMISSION OVER TEMP” message may display and the transmission may downshift out of Overdrive until the transmission cools down. After cooldown, the transmission will resume normal operation.

In high ambient temperatures with sustained high engine speed and load, an upshift followed shortly thereafter by

a downshift may occur. This is a normal part of the overheat protection strategy when operating in the “Tow/Haul” mode.

The transmission will downshift from Overdrive to the most desirable gear if the accelerator pedal is fully depressed at vehicle speeds above approximately 35 mph (56 km/h).

When To Use “TOW/HAUL” Mode — If Equipped

When driving in hilly areas, towing a trailer, carrying a heavy load, etc., and frequent transmission shifting occurs, press the “TOW/HAUL” button. This will improve performance and reduce the potential for transmission overheating or failure due to excessive shifting. When operating in “TOW/HAUL” mode, the transmission will shift to 3rd gear and 4th will be enabled under steady cruise conditions.

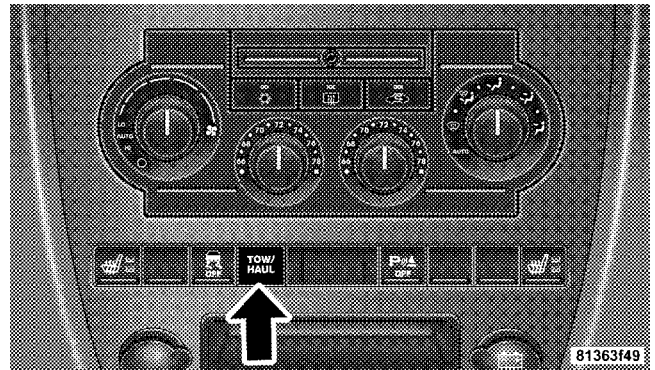

Tow/Haul Button

The “TOW/HAUL” light will illuminate in the instrument cluster to indicate when the switch has been activated. Pressing the switch a second time restores normal operation. If the “TOW/HAUL” mode is desired, the switch must be pressed each time the engine is started.

Torque Converter Clutch

A feature designed to improve fuel economy is included in all automatic transmissions. A clutch within the torque converter engages automatically at a calibrated speed at light throttle. It engages at higher speeds under heavier acceleration. This may result in a slightly different feeling or response during normal operation in high gear. When the vehicle speed drops below a calibrated speed, or during acceleration, the clutch automatically and smoothly disengages. The feature is operational in Overdrive and in Drive.

NOTE: The torque converter clutch will not engage until the transmission fluid and engine coolant are warm [usually after 1-3 miles (1.6 - 4.8 km) of driving]. Because the engine speed is higher when the torque converter clutch is not engaged, it may seem as if the transmission is not shifting into Overdrive when cold. This is normal. Manually shifting between 3 (third gear) and 4 (fourth

gear) positions (using the ERS shift control) will demonstrate that the transmission is able to shift into and out of Overdrive.

NOTE: If the vehicle has not been driven in several days, the first few seconds of operation after shifting the transmission into gear may seem sluggish. This is due to the fluid partially draining from the torque converter into the transmission. This condition is normal and will not cause damage to the transmission. The torque converter will refill within five seconds of shifting from Park into any other gear position.

Rocking the Vehicle

If the vehicle becomes stuck in snow, sand, or mud, it can often be moved by a rocking motion. Move the gear selector rhythmically between D (Drive) and R (Reverse), while applying slight pressure to the accelerator.

NOTE: The Electronic Stability Program (ESP) and Traction Control (if equipped) should be turned OFF before attempting to rock the vehicle. Refer to Section 3 of this manual.

The least amount of accelerator pedal pressure to maintain the rocking motion without spinning the wheels or racing the engine is most effective. Racing the engine or spinning the wheels, due to the frustration of not freeing the vehicle, may lead to transmission overheating and failure. Allow the engine to idle with the transmission selector in N (Neutral) for at least one minute after every five rocking-motion cycles. This will minimize overheating and reduce the risk of transmission failure during prolonged efforts to free a stuck vehicle.

CAUTION!

When “rocking” a stuck vehicle by moving between “First” and R (Reverse), do not spin the wheels faster than 15 mph (24 km/h), or drivetrain damage may result.

FOUR-WHEEL DRIVE OPERATION

Quadra-Trac I® Operating Instructions/Precautions — If Equipped

The Quadra-Trac I® is a single speed (HI range only) transfer case which provides convenient full-time 4-wheel drive. No driver interaction is required. This transfer case divides engine torque almost evenly with 48 percent of engine torque to the front axle and 52 percent of engine torque to the rear axle. The Brake Traction Control System (BTC), which combines standard ABS

and Traction Control, provides resistance to any wheel that is slipping to allow additional torque transfer to wheels with traction.

NOTE: The Quadra-Trac I® system is not appropriate for conditions where LOW range is recommended. Refer to “Off-Road Driving Tips” in this section.

Quadra-Trac II® Operating Instructions/Precautions — If Equipped

The Quadra-Trac II® transfer case is fully automatic in the normal driving 4 HI mode. The Quadra-Trac II® transfer case provides three mode positions — four wheel drive high range, neutral, and four wheel drive low range.

This transfer case is fully automatic in the 4 HI mode. This transfer case divides engine torque almost evenly with 48 percent of engine torque to the front axle and 52 percent of engine torque to the rear axle. When speed differences are increased between the front and rear drive

shafts, the transfer case can transmit up to 100 percent of available engine torque to the front or rear drive shafts.

When additional traction is required, the 4 LOW position can be used to lock the front and rear driveshafts together and force the front and rear wheels to rotate at the same speed. The 4 LOW position is intended for loose, slippery road surfaces only. Driving in the 4 LOW position on dry hard surfaced roads may cause increased tire wear and damage to driveline components.

When operating your vehicle in 4 LOW, the engine speed is approximately three times that of the 4 HI position at a given road speed. Take care not to overspeed the engine and do not exceed 25 mph (40 km/h).

Proper operation of four wheel drive vehicles depends on tires of equal size, type, and circumference on each wheel. Any difference will adversely affect shifting and cause damage to the transfer case.

Because four wheel drive provides improved traction, there is a tendency to exceed safe turning and stopping speeds. Do not go faster than road conditions permit.

WARNING!

You or others could be injured if you leave the vehicle unattended with the transfer case in the N (Neutral) position without first fully engaging the parking brake. The transfer case N (Neutral) position disengages both the front and rear driveshafts from the powertrain and will allow the vehicle to move regardless of the transmission position. The parking brake should always be applied when the driver is not in the vehicle.

Shift Positions

For additional information on the appropriate use of each transfer case mode position, see the information below:

4 HI

Four Wheel Drive High Range — All roads surfaces such as ice, snow, gravel, sand, and dry hard pavement.

N (Neutral)

Neutral — Disengages both the front and rear driveshafts from the powertrain. To be used for flat towing behind another vehicle. Refer to “Recreational Towing” in Section 5 of this manual.

4 LOW

Four Wheel Drive Low Range — Low speed 4 wheel drive. Locks the front and rear driveshafts together. Forces the front and rear wheels to rotate at the same

speed. Additional traction and maximum pulling power for loose, slippery road surfaces only. Do not exceed 25 mph (40 km/h).

Shifting Procedures

4 HI to 4 LOW

With the vehicle at speeds of 0 to 3 mph (0 to 5 km/h), key ON or engine running, shift the transmission into N (Neutral), and raise the transfer case T-handle. “The 4WD LOW Indicator Lamp” in the instrument cluster will begin to flash and remain on solid when the shift is complete. Release the T-handle.

NOTE: If shift conditions/interlocks are not met, or a transfer case motor temperature protection condition exists, a “CHECK SHIFT PROCEDURES” message will flash from the EVIC (Electronic Vehicle Information Center). Refer to “Electronic Vehicle Information Center (EVIC)” in Section 4 of this manual.

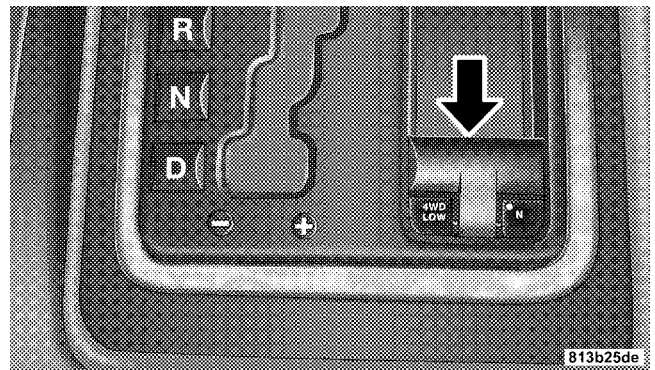

Shifter T-Handle

4 LOW to 4 HI

With the vehicle at speeds of 0 to 3 mph (0 to 5 km/h), key ON or engine running, shift the transmission into N (Neutral), and raise the transfer case T-handle. The “4WD

LOW Indicator Lamp” in the instrument cluster will flash and go out when the shift is complete. Release the T-handle.

NOTE: If shift conditions/interlocks are not met, or a transfer case motor temperature protection condition exists, a “CHECK SHIFT PROCEDURES” message will flash from the EVIC (Electronic Vehicle Information Center). Refer to “Electronic Vehicle Information Center (EVIC)” in Section 4 of this manual.

NOTE: Shifting into or out of 4WD LOW is possible with the vehicle completely stopped, however difficulty may occur due to the mating clutch teeth not being properly aligned. Several attempts may be required for clutch teeth alignment and shift completion to occur. The preferred method is with the vehicle rolling 0 to 3 mph (0 to 5 km/h). If the vehicle is moving faster than 3 mph (5 km/h), the transfer case will not allow the shift.

Neutral (N) Shift Procedure

1. Key ON, engine off.
2. Vehicle stopped, with foot on brake.
3. Place transmission in N (Neutral).
4. Hold down N (Neutral) “pin” switch (with a pen, etc.) for 4 seconds until the LED lamp by the switch starts to blink indicating shift in progress. Lamp will stop blinking (stay on solid) when Neutral shift is complete. A “4WD SYSTEM IN NEUTRAL” message will display on the EVIC (Electronic Vehicle Information Center). Refer to “Electronic Vehicle Information Center (EVIC)” in Section 4 of this manual.
5. Repeat Steps 1– 4 to shift out of Neutral.

NOTE: If shift conditions/interlocks are not met, a “CHECK SHIFT PROCEDURES” message will flash from

the EVIC (Electronic Vehicle Information Center). Refer to “Electronic Vehicle Information Center (EVIC)” in Section 4 of this manual.

Quadra-Drive® System — If Equipped

The optional Quadra-Drive® System features three torque transfer couplings. The couplings include ELSD (Electronic Limited Slip Differential) front and rear axles and Quadra-Trac II® transfer case. The optional ELSD axles are fully automatic and require no driver input to operate. Under normal driving conditions the units function as standard axles balancing torque evenly between left and right wheels. With a traction difference between left and right wheels the coupling will sense a speed difference. As one wheel begins to spin faster than the other, torque will automatically transfer from the wheel that has less traction to the wheel that has traction. While the transfer case and axle couplings differ in design, their

operation is similar. Follow the Quadra-Trac II® transfer case shifting information, preceding this section, for shifting this system.

PARKING BRAKE

To set the parking brake, pull the lever up as firmly as possible. When the parking brake is applied with the ignition ON, the “Brake Warning Light” in the instrument cluster will light.

NOTE: The instrument cluster “Brake Warning Light” indicates only that the parking brake is applied. It does not indicate the degree of brake application.

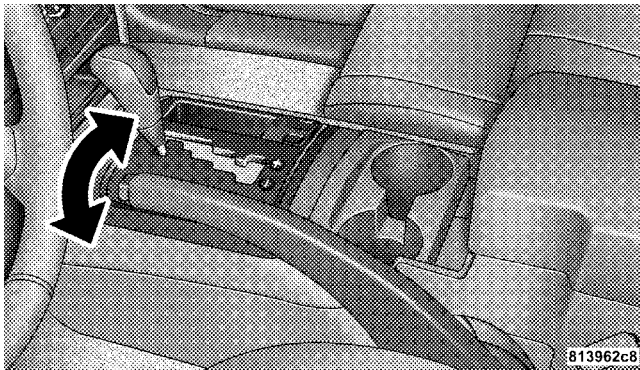

Parking Brake

Before leaving the vehicle parked on a hill, you must make sure the parking brake is fully applied and place the gear selector in the P (Park) position. Make certain the transfer case is in gear. Failure to do so may cause the vehicle to roll and cause damage or injury.

When parking on a hill, it is important to set the parking brake before placing the gear selector in P (Park), otherwise the load on the transmission locking mechanism may make it difficult to move the selector out of P (Park).

The parking brake should always be applied when the driver is not in the vehicle.

WARNING!

- Leaving children unattended in a vehicle is dangerous for a number of reasons. A child or others could be injured. Children should be warned not to touch the parking brake or the gear selector lever. Don't leave the keys in the ignition. A child could operate power windows, other controls, or move the vehicle.
- Do not leave children or animals inside parked vehicles in hot weather. Interior heat build up may cause serious injury or death.

To release the parking brake, pull up slightly, press the center button, then lower the lever completely.

Be sure the parking brake is fully disengaged before driving. Failure to do so can lead to brake failure.

NOTE: Parking brake adjustment and maintenance should be performed by your authorized dealer.

ANTI-LOCK BRAKE SYSTEM

The Anti-Lock Brake System (ABS) is designed to aid the driver in maintaining vehicle control under adverse braking conditions. The system operates with a separate computer to modulate hydraulic pressure to prevent wheel lock-up and help avoid skidding on slippery surfaces.

All vehicle wheels and tires must be the same size and type and tires must be properly inflated to produce accurate signals for the computer.

WARNING!

Significant over or under inflation of tires, or mixing sizes of tires or wheels on the vehicle can lead to loss of braking effectiveness.

The Anti-Lock Brake System conducts a low-speed self-test at about 12 mph (20 km/h). If you have your foot lightly on the brake while this test is occurring you may feel slight pedal movement. The movement can be more apparent on ice and snow. This is normal.

The Anti-Lock Brake System pump motor runs during the self-test at 12 mph (20 km/h) and during an ABS stop. The pump motor makes a low humming noise during operation, which is normal.

WARNING!

Pumping of the Anti-Lock Brakes will diminish their effectiveness and may lead to an accident. Pumping makes the stopping distance longer. Just press firmly on your brake pedal when you need to slow down or stop.

WARNING!

- The Anti-Lock Brake System (ABS) cannot prevent the natural laws of physics from acting on the vehicle, nor can it increase braking or steering efficiency beyond that afforded by the condition of the vehicle brakes and tires or the traction afforded.
- The ABS cannot prevent accidents, including those resulting from excessive speed in turns, following another vehicle too closely, or hydroplaning. Only a safe, attentive, and skillful driver can prevent accidents.
- The capabilities of an ABS equipped vehicle must never be exploited in a reckless or dangerous manner which could jeopardize the user's safety or the safety of others.

CAUTION!

The Anti-Lock Brake System is subject to possible detrimental effects of electronic interference caused by improperly installed after-market radios or telephones.

NOTE: During severe braking conditions, a pulsing sensation may occur and a clicking noise will be heard. This is normal, indicating that the Anti-Lock Brake System is functioning.

WARNING!

To use your brakes and accelerator more safely, follow these tips:

- Do not “ride” the brakes by resting your foot on the pedal. This could overheat the brakes and result in unpredictable braking action, longer stopping distances, or brake damage.
- When descending mountains or hills, repeated braking can cause brake fade with loss of braking control. Avoid repeated heavy braking by downshifting the transmission or locking out overdrive whenever possible.
- Engines may idle at higher speeds during warm-up, which could cause rear wheels to spin and result in loss of vehicle control. Be especially careful while driving on slippery roads, in close-quarter maneuvering, parking or stopping.
- Do not drive too fast for road conditions, especially when roads are wet or slushy. A wedge of water can

build up between the tire tread and the road. This hydroplaning action can cause loss of traction, braking ability, and control.

- After going through deep water or a car wash, brakes may become wet, resulting in decreased performance and unpredictable braking action. Dry the brakes by gentle, intermittent pedal action while driving at very slow speeds.

VARI-LOK REAR AXLE — IF EQUIPPED

The optional Vari-Lok axle is fully automatic and requires no driver input to operate. Under normal driving conditions the unit functions as a standard axle balancing torque evenly between left and right wheels. With a traction difference between left and right wheels the coupling will sense a speed difference. As one wheel begins to spin faster than the other, torque will automatically transfer from the wheel that has less traction to the wheel that has traction.

ON-ROAD DRIVING TIPS

Utility vehicles have higher ground clearance and a narrower track to make them capable of performing in a wide variety of off-road applications. Specific design characteristics give them a higher center of gravity than ordinary cars.

An advantage of the higher ground clearance is a better view of the road, allowing you to anticipate problems. They are not designed for cornering at the same speeds as conventional 2-wheel drive vehicles any more than low-slung sports cars are designed to perform satisfactorily in off-road conditions. If at all possible, avoid sharp turns or abrupt maneuvers. As with other vehicles of this type, failure to operate this vehicle correctly may result in loss of control or vehicle rollover.

OFF-ROAD DRIVING TIPS

NOTE: Prior to off-road driving, remove the front air dam to prevent damage. The front air dam is attached to the lower front fascia with quarter turn fasteners, and can be removed by hand.

When To Use 4WD LOW Range — If Equipped

When off-road driving, shift to 4WD LOW for additional traction. This range should be limited to extreme situations such as deep snow, mud, or sand where additional low speed pulling power is needed. Vehicle speeds in excess of 25 mph (40 km/h) should be avoided when in 4WD LOW range.

Driving Through Water

Although your vehicle is capable of driving through water, there are a number of precautions that must be considered before entering the water:

CAUTION!

When driving through water, do not exceed 5 mph (8 km/h). Always check water depth before entering as a precaution, and check all fluids afterward. Driving through water may cause damage that may not be covered by the new vehicle limited warranty.

Driving through water more than a few inches deep will require extra caution to ensure safety and prevent damage to your vehicle. If you must drive through water, try to determine the depth and the bottom condition (and location of any obstacles) prior to entering. Proceed with caution and maintain a steady controlled speed less than 5 mph (8 km/h) in deep water to minimize wave effects.

Flowing Water

If the water is swift flowing and rising (as in storm run-off) avoid crossing until the water level recedes

and/or the flow rate is reduced. If you must cross flowing water avoid depths in excess of 9 inches. The flowing water can erode the streambed causing your vehicle to sink into deeper water. Determine exit point(s) that are downstream of your entry point to allow for drifting.

Standing Water

Avoid driving in standing water deeper than 20 inches, and reduce speed appropriately to minimize wave effects. Maximum speed in 20 inches of water is less than 5 mph (8 km/h).

Maintenance

After driving through deep water, inspect your vehicle fluids and lubricants (engine oil, transmission oil, axle, transfer case) to assure the fluids have not been contaminated. Contaminated fluid (milky, foamy in appearance) should be flushed/changed as soon as possible to prevent component damage.

Driving In Snow, Mud and Sand

In heavy snow, when pulling a load, or for additional control at slower speeds, shift the transmission to a low gear and shift the transfer case to 4WD LOW if necessary. Refer to "Four-Wheel Drive Operation" in this section. Do not shift to a lower gear than necessary to maintain headway. Over-revving the engine can spin the wheels and traction will be lost.

Avoid abrupt downshifts on icy or slippery roads, because engine braking may cause skidding and loss of control.

Hill Climbing

NOTE: Before attempting to climb a hill, determine the conditions at the crest and/or on the other side.

Before climbing a steep hill, shift the transmission to a lower gear and shift the transfer case to 4WD LOW. Use first gear and 4WD LOW for very steep hills.

If you stall or begin to lose headway while climbing a steep hill, allow your vehicle to come to a stop and immediately apply the brakes. Restart the engine and shift to R (Reverse). Back slowly down the hill allowing the compression braking of the engine to help regulate your speed. If the brakes are required to control vehicle speed, apply them lightly and avoid locking or skidding the tires.

WARNING!

If the engine stalls or you lose headway or cannot make it to the top of a steep hill or grade, never attempt to turn around. To do so may result in tipping and rolling the vehicle. Always back carefully straight down a hill in R (Reverse) gear. Never back down a hill in N (Neutral) using only the brake.

Remember, never drive diagonally across a hill-always drive straight up or down.

If the wheels start to slip as you approach the crest of a hill, ease off the accelerator and maintain headway by turning the front wheels slowly. This may provide a fresh “bite” into the surface and will usually provide traction to complete the climb.

Traction Downhill

Shift the transmission into a low gear and the transfer case to 4WD LOW range. Let the vehicle go slowly down the hill with all four wheels turning against engine compression drag. This will permit you to control the vehicle speed and direction.

When descending mountains or hills, repeated braking can cause brake fade with loss of braking control. Avoid repeated heavy braking by downshifting the transmission whenever possible.

After Driving Off-Road

Off-road operation puts more stress on your vehicle than does most on-road driving. After going off-road it is always a good idea to check for damage. That way you can get any problems taken care of right away and have your vehicle ready when you need it.

- Completely inspect the underbody of your vehicle. Check tires, body structure, steering, suspension, and exhaust system for damage.
- Check threaded fasteners for looseness, particularly on the chassis, drivetrain components, steering, and suspension. Retighten them, if required, and torque to the values specified in the Service Manual.
- Check for accumulations of plants or brush. These things could be a fire hazard. They might hide damage to fuel lines, brake hoses, axle pinion seals, and propeller shafts.

- After extended operation in mud, sand, water, or similar dirty conditions, have brake rotors, wheels, brake linings, and axle yokes inspected and cleaned as soon as possible.

WARNING!

Abrasive material in any part of the brakes may cause excessive wear or unpredictable braking. You might not have full braking power when you need it to prevent an accident. If you have been operating your vehicle in dirty conditions, get your brakes checked and cleaned as necessary.

- If you experience unusual vibration after driving in mud, slush or similar conditions, check the wheels for impacted material. Impacted material can cause a wheel imbalance and freeing the wheels of it will correct the situation.

MULTI DISPLACEMENT SYSTEM (MDS) - 5.7L Engine Only

This feature offers improved fuel economy by shutting off four of the engine's eight cylinders during light load and cruise conditions. The system is automatic with no driver inputs or additional driving skills required.

NOTE: This system must be reset if the vehicle battery is disconnected. See your authorized dealer for service.

TIRE SAFETY INFORMATION

Tire Markings

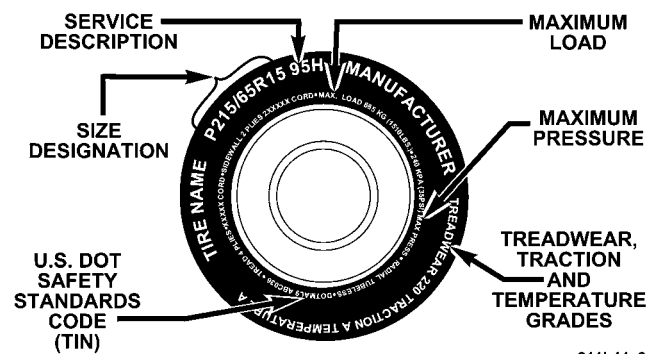

811b44e8

NOTE:

- P(Passenger)-Metric tire sizing is based on U.S. design standards. P-Metric tires have the letter "P" molded into the sidewall preceding the size designation. Example: P215/65R15 95H.

- European Metric tire sizing is based on European design standards. Tires designed to this standard have the tire size molded into the sidewall beginning with the section width. The letter "P" is absent from this tire size designation. Example: 215/65R15 96H
- LT(Light Truck)-Metric tire sizing is based on U.S. design standards. The size designation for LT-Metric tires is the same as for P-Metric tires except for the letters "LT" that are molded into the sidewall preceding the size designation. Example: LT235/85R16.
- Temporary Spare tires are high pressure compact spares designed for temporary emergency use only. Tires designed to this standard have the letter "T" molded into the sidewall preceding the size designation. Example: T145/80D18 103M.
- High Flotation tire sizing is based on U.S. design standards and begins with the tire diameter molded into the sidewall. Example: 31x10.5 R15 LT.

Tire Sizing Chart

EXAMPLE:	
Size Designation:	
	P = Passenger car tire size based on U.S. design standards
	"...blank..." = Passenger car tire based on European design standards
	LT = Light Truck tire based on U.S. design standards
	T = Temporary Spare tire
	31 = Overall Diameter in Inches (in)
	215 = Section Width in Millimeters (mm)
	65 = Aspect Ratio in Percent (%) —Ratio of section height to section width of tire.
	10.5 = Section Width in Inches (in)
	R = Construction Code —"R" means Radial Construction. —"D" means Diagonal or Bias Construction.
	15 = Rim Diameter in Inches (in)

EXAMPLE:**Service Description:**

95 = Load Index

—A numerical code associated with the maximum load a tire can carry.

H = Speed Symbol

—A symbol indicating the range of speeds at which a tire can carry a load corresponding to its load index under certain operating conditions.

—The maximum speed corresponding to the Speed Symbol should only be achieved under specified operating conditions. (ie. tire pressure, vehicle loading, road conditions and posted speed limits).

Load Identification:

"...blank..." = Absence of any text on sidewall of the tire indicates a Standard Load (SL) Tire

Extra Load (XL) = Extra Load (or Reinforced) Tire

Light Load = Light Load Tire

C,D,E = Load range associated with the maximum load a tire can carry at a specified pressure

Maximum Load — Maximum Load indicates the maximum load this tire is designed to carry.

Maximum Pressure — Maximum Pressure indicates the maximum permissible cold tire inflation pressure for this tire.

Tire Identification Number (TIN)

The TIN may be found on one or both sides of the tire however the date code may only be on one side. Tires with white sidewalls will have the full TIN including date code located on the white sidewall side of the tire.

Look for the TIN on the outboard side of black sidewall tires as mounted on the vehicle. If the TIN is not found on the outboard side then you will find it on the inboard side of the tire.

EXAMPLE:
DOT MA L9 ABCD 0301
DOT = Department of Transportation —This symbol certifies that the tire is in compliance with the U.S. Department of Transportation tire safety standards, and is approved for highway use.
MA = Code representing the tire manufacturing location.(2 digits)
L9 = Code representing the tire size.(2 digits)
ABCD = Code used by tire manufacturer.(1 to 4 digits)
03 = Number representing the week in which the tire was manufactured.(2 digits) —03 means the 3rd week.
01 = Number representing the year in which the tire was manufactured.(2 digits) —01 means the year 2001. —Prior to July 2000, tire manufacturers were only required to have 1 number to represent the year in which the tire was manufactured. Example: 031 could represent the 3rd week of 1981 or 1991.

Tire Loading and Tire Pressure

Tire Placard Location

NOTE: The proper cold tire inflation pressure for passenger cars is listed on either the face of the driver's door or the driver's side "B" pillar. For vehicles other than passenger cars, the cold tire inflation pressures are listed on either the shutface of the driver's door, the "B" pillar, the Certification Label or in the Tire Inflation Pressures brochure in the glove compartment.

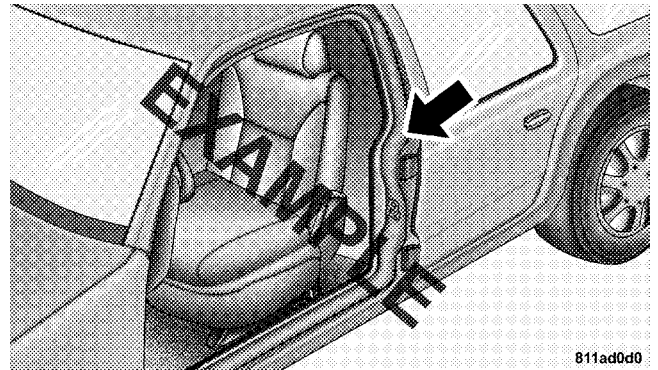

Tire Placard Location

Tire and Loading Information Placard

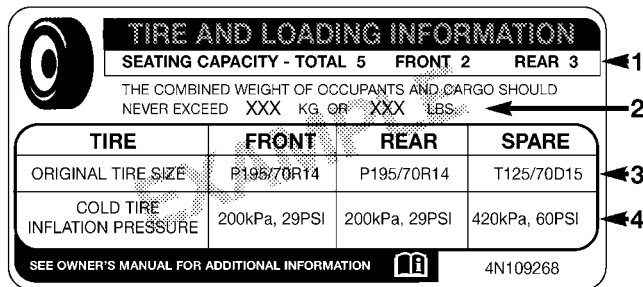

Tire and Loading Information

811b5a9a

This placard tells you important information about the:

- 1) number of people that can be carried in the vehicle
- 2) the total weight your vehicle can carry
- 3) the tire size designed for your vehicle
- 4) the cold tire inflation pressures for the front, rear and spare tires.

Loading

The vehicle maximum load on the tire must not exceed the load carrying capacity of the tire on your vehicle. You will not exceed the tire’s load carrying capacity if you adhere to the loading conditions, tire size and cold tire inflation pressures specified on the Tire and Loading Information placard and the Vehicle Loading section of this manual.

NOTE: Under a maximum loaded vehicle condition, gross axle weight ratings (GAWR’s) for the front and rear axles must not be exceeded. For further information on GAWR’s, vehicle loading and trailer towing, see the Vehicle Loading section of this manual.

To determine the maximum loading conditions of your vehicle, locate the statement “The combined weight of occupants and cargo should never exceed XXX kg or XXX lbs.” on the Tire and Loading Information placard. The

combined weight of occupants, cargo/luggage and trailer tongue weight (if applicable) should never exceed the weight referenced here.

Steps for Determining Correct Load Limit

1. Locate the statement "The combined weight of occupants and cargo should never exceed XXX pounds" on your vehicle's placard.
2. Determine the combined weight of the driver and passengers that will be riding in your vehicle.
3. Subtract the combined weight of the driver and passengers from XXX kilograms or XXX pounds.
4. The resulting figure equals the available amount of cargo and luggage load capacity. For example, if "XXX" amount equals 1400 lbs. and there will be five 150 lb. passengers in your vehicle, the amount of available cargo and luggage load capacity is 650 lb. (since $5 \times 150 = 750$, and $1400 - 750 = 650$ lb.)

5. Determine the combined weight of luggage and cargo being loaded on the vehicle. That weight may not safely exceed the available cargo and luggage load capacity calculated in step 4.

6. If your vehicle will be towing a trailer, load from your trailer will be transferred to your vehicle. Consult this manual to determine how this reduces the available cargo and luggage load capacity of your vehicle.

NOTE: The following table shows examples on how to calculate total load, cargo/luggage and towing capacities of your vehicle with varying seating configurations and number and size of occupants. This table is for illustration purposes only and may not be accurate for the seating and load carry capacity of your vehicle.

NOTE: For the following example the combined weight of occupants and cargo should never exceed 865 lbs. (392 Kg).

262 STARTING AND OPERATING

Occupants			Combined weight of occupants and cargo from Tire Placard	MINUS	Combined Occupant's weight	=	AVAILABLE Cargo/Luggage and Trailer Tongue Weight
TOTAL	FRONT	REAR					
<u>EXAMPLE 1</u>			865 lbs	minus	Occupant 1: 200 lbs Occupant 2: 130 lbs Occupant 3: 160 lbs Occupant 4: 100 lbs Occupant 5: 80 lbs TOTAL WEIGHT: 670 lbs	=	195 lbs
5	2	3					
<u>EXAMPLE 2</u>			865 lbs	minus	Occupant 1: 210 lbs Occupant 2: 180 lbs Occupant 3: 150 lbs TOTAL WEIGHT: 540 lbs	=	325 lbs
3	2	1					
<u>EXAMPLE 3</u>			865 lbs	minus	Occupant 1: 200 lbs Occupant 2: 200 lbs TOTAL WEIGHT: 400 lbs	=	465 lbs
2	2	0					

WARNING!

Overloading of your tires is dangerous. Overloading can cause tire failure, affect vehicle handling, and increase your stopping distance. Use tires of the recommended load capacity for your vehicle. Never overload them.

TIRES — GENERAL INFORMATION

Proper tire inflation pressure is essential to the safe and satisfactory operation of your vehicle. Three primary areas are affected by improper tire pressure:

1. Safety—**WARNING!**

Improperly inflated tires are dangerous and can cause accidents.

- Under inflation increases tire flexing and can result in tire failure.
- Over inflation reduces a tire's ability to cushion shock. Objects on the road and chuck holes can cause damage that results in tire failure.
- Unequal tire pressures can cause steering problems. You could lose control of your vehicle.
- Overinflated or under inflated tires can affect vehicle handling and can fail suddenly, resulting in loss of vehicle control.

Always drive with each tire properly inflated.

2. *Economy*—

Improper inflation pressures can cause uneven wear patterns to develop across the tire tread. These abnormal wear patterns will reduce tread life resulting in a need for earlier tire replacement. Under inflation also increases tire rolling resistance and results in higher fuel consumption.

3. *Ride Comfort and Vehicle Stability*—

Proper tire inflation contributes to a comfortable ride. Over inflation produces a jarring and uncomfortable ride. Both under inflation and over inflation affect the stability of the vehicle and can produce a feeling of sluggish response or over responsiveness in the steering.

Unequal tire pressures can cause erratic and unpredictable steering response.

Unequal tire pressure from side to side may cause the vehicle to drift left or right.

Tire Inflation Pressures

The proper cold tire inflation pressure is listed on either the face of the driver's door, or the driver's side "B" pillar.

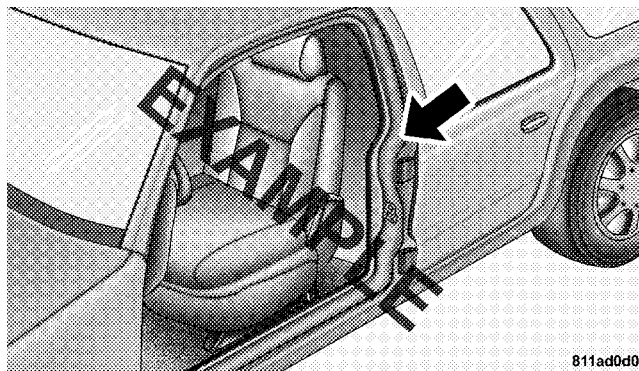

Tire Placard Location

The "Cold Inflation Pressure" of each tire should be checked and adjusted at least once every month. Check

more often if subject to a wide range of outdoor temperatures, as tire pressures vary with temperature changes.

Inflation pressures specified on the label are always "Cold Inflation Pressure." Cold inflation pressure is defined as the tire pressure after the vehicle has been idle for at least 3 hours, or driven less than a mile after a 3 hour period. The cold inflation pressure of each tire should be set according to the manufacturers recommended pressure, and must not exceed the maximum values molded into the tire sidewall.

Tire pressures may increase from 13 to 40 kPa (2 to 6 psi) [0.138 to 0.414 bar] during operation. DO NOT reduce this normal pressure buildup.

High Speed Operation

WARNING!

High speed driving with your vehicle under load is dangerous. The added strain on your tires could cause them to fail. You could have a serious accident. Don't drive a vehicle loaded to maximum capacity at continuous speeds above 75 mph (120 km/h).

The manufacturer advocates driving at safe speeds within posted speed limits. Where speed limits or conditions are such that the vehicle can be driven at high speeds, correct tire inflation pressure is very important.

Radial-Ply Tires

WARNING!

Combining radial ply tires with other types of tires on your vehicle will cause your vehicle to handle poorly. The instability could cause an accident. Always use radial tires in sets of four. Never combine them with other types of tires.

Cuts and punctures in radial tires are repairable only in the tread area because of sidewall flexing. Consult your dealer for radial tire repairs.

Tire Spinning

When stuck in mud, sand, snow, or ice conditions, do not spin your vehicle's wheels above 35 mph (55 km/h).

WARNING!

Fast spinning tires can be dangerous. Forces generated by excessive wheel speeds may cause tire damage or failure. A tire could explode and injure someone. Do not spin your vehicle's wheels faster than 35 mph (55 km/h) when you are stuck, and do not let anyone near a spinning wheel no matter what the speed.

Tread Wear Indicators

These indicators are narrow strips 1/16 inch (1.6 mm) thick and are found in the tread pattern grooves.

When the tread pattern is worn down to these treadwear indicators, the tires should be replaced.

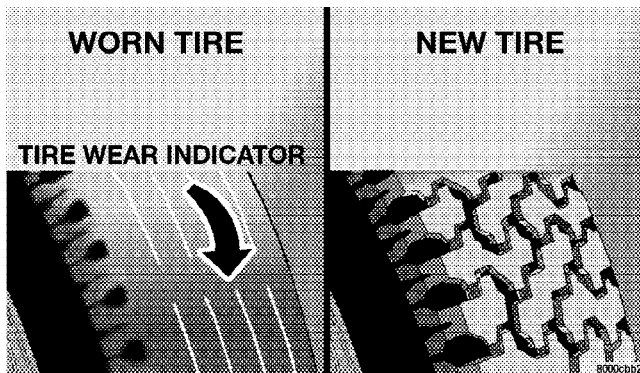

Overloading your vehicle, long trips in very hot weather, and driving on bad roads may result in greater wear.

Replacement Tires

The tires on your new vehicle provide a balance of many characteristics. They should be inspected regularly for wear and correct inflation pressure. The manufacturer strongly recommends that you use tires equivalent to the originals in quality and performance when replacement is needed (see section on tread wear indicators). Failure to use equivalent replacement tires may adversely affect the safety, handling, ride and fuel economy of your vehicle. We recommend that you contact your original equipment tire dealer on any questions you may have on tire specifications or capability.

WARNING!

- Do not use a tire, wheel size or rating other than that specified for your vehicle. Some combinations of unapproved tires and wheels may change suspension dimensions and performance characteristics, resulting in changes to steering, handling, and braking of your vehicle. This can cause unpredictable handling and stress to steering and suspension components. You could lose control and have an accident resulting in serious injury or death. Use only the tire and wheel sizes with load ratings approved for your vehicle.
- Never use a tire smaller than the minimum tire size listed on your vehicle's tire label. Using a smaller tire could result in tire overloading and failure. You could lose control and have an accident.
- Failure to equip your vehicle with tires having adequate speed capability can result in sudden tire failure and loss of vehicle control.
- Overloading your tires is dangerous. Overloading can cause tire failure. Use tires of the recommended load capacity for your vehicle - never overload them.

CAUTION!

Replacing original tires with tires of a different size may result in false speedometer and odometer readings. Check with your dealer before replacing tires with a different size.

Alignment and Balance

The suspension components of your vehicle should be inspected and aligned when needed, to obtain maximum tire tread life.

Poor suspension alignment may result in:

- reduced tread life;
- uneven tire wear, such as feathering and one-sided wear;
- vehicle pull to the right or to the left.

Tires may also cause the vehicle to pull left or right. Alignment will not correct this problem. See your dealer for proper diagnosis of the problem.

Improper alignment will not normally cause vehicle vibration, which may be a result of tire and wheel out-of-balance. Proper balancing will reduce vibration and avoid tire cupping and spotty wear.

TIRE PRESSURE MONITOR SYSTEM

Tire Pressure Monitoring — Base System

The Tire Pressure Monitor System (TPM) system uses wireless technology with wheel rim mounted electronic sensors to monitor tire pressure levels. Sensors, mounted to each wheel as part of the valve stem, transmit tire pressure readings to the Receiver Module.

NOTE: It is particularly important, for you to check the tire pressure in all of your tires regularly and to maintain the proper pressure.



The “Tire Pressure Monitoring Indicator Lamp” will illuminate in the instrument cluster, and an audible chime will be activated when one or more tire pressures is low. The “Tire Pressure Monitoring Indicator Lamp” will flash on and off for ten seconds when a system fault is detected. The flash cycle will repeat every ten minutes or until the fault condition is removed and reset.

The Tire Pressure Monitoring System consists of the following components:

- Receiver Module
- 5 Wheel Sensors (including Full Size Spare Tire)
- Amber Colored Tire Pressure Monitoring Indicator Lamp

The system will consist of tire pressure monitoring sensors attached to each wheel through the valve stem mounting hole, a central receiver module and an amber

colored Indicator Lamp. A sensor is located in the spare wheel if the vehicle is equipped with a matching full size spare wheel and tire assembly.

NOTE: For vehicles with optional wheel/tire sizes and significantly different tire placard pressures, the placard pressure value and the low-pressure threshold value is re-programmable at your authorized dealer to accommodate the customer selected wheel/tire combinations recommended by DaimlerChrysler Corporation.

CAUTION!

The TPM system has been optimized for the original equipment tires and wheels. TPM system pressures have been established for the tire size equipped on your vehicle. Undesirable system operation or sensor damage may result when using replacement equipment that is not of the same size, type, and/or style. After-market wheels can cause sensor damage. Do not use tire sealant from a can, or balance beads if your vehicle is equipped with a TPM system, as damage to the sensors may result.

CAUTION!

After inspecting or adjusting the tire pressure always reinstall the valve stem cap. This will prevent moisture and dirt from entering the valve stem, which could damage the wheel rim sensor.

NOTE:

- The TPM system can inform the driver of a low tire pressure condition.
- The TPM system is not intended to replace normal tire care and maintenance, nor to provide warning of a tire failure or condition.
- The TPM system should not be used as a tire pressure gauge while adjusting your tire pressure.

Tire Pressure Monitoring — Premium System

The Tire Pressure Monitor System (TPM) system uses wireless technology with wheel rim mounted electronic sensors to monitor tire pressure levels. Sensors mounted to each wheel as part of the valve stem transmit tire pressure readings to the Receiver Module. The wheel sensors monitor tire pressure, and status for all four active road tires and the spare tire. The spare tire pressure is monitored, but not displayed.

NOTE: It is particularly important, for you to check the tire pressure in all of your tires regularly and to maintain the proper pressure.



The “Tire Pressure Monitoring Indicator Lamp” will illuminate in the instrument cluster, and an audible chime will be activated when one or more tire pressures is low. The “Tire Pressure Monitoring Indicator Lamp” will flash on and off for ten seconds

when a system fault is detected. The flash cycle will repeat every ten minutes or until the fault condition is removed and reset.

The Tire Pressure Monitoring System consists of the following components:

- Receiver Module
- 5 Wheel Sensors (including Full Size Spare Tire)
- 4 Wheel Sensor Trigger Modules
- Tire Pressure Monitoring System Display Messages in the EVIC
- Amber Colored Tire Pressure Monitoring Indicator Lamp

The system consists of tire pressure monitoring sensors attached to each wheel through the valve stem mounting hole, a central receiver module, Wheel Sensor Trigger Modules mounted in three of the four wheel wells,

various Tire Pressure Monitoring System Display Messages in the EVIC, and an amber colored Indicator Lamp. A sensor shall be installed in the spare wheel if the vehicle is equipped with a matching full size spare wheel and tire assembly.

NOTE: For vehicles with optional wheel/tire sizes and significantly different tire placard pressures, the placard pressure value and the low-pressure threshold value is re-programmable at your authorized dealer to accommodate the customer selected wheel/tire combinations recommended by DaimlerChrysler Corporation.

The following "warnings" will cause a text message to be displayed, an audible chime to sound and the "Tire Pressure Indicator Lamp" to illuminate. The audible chime will occur once every ignition cycle for each "warning" detected. The "Tire Pressure Indicator Lamp"

will illuminate continuously (solid) and shall remain illuminated until the warning condition is removed/reset.

NOTE: The Indicator Lamp will only illuminate for the four active road tires. A low spare tire pressure will not cause the Indicator Lamp to illuminate

When the appropriate conditions exist, the Electronic Vehicle Information Center (EVIC) displays the following messages.

**LEFT FRONT, LEFT REAR, RIGHT FRONT,
RIGHT REAR, SPARE LOW PRESSURE**

One or more of these messages will be displayed in the EVIC if a low tire pressure condition exists in one or more tires.

Inspect all tires for proper inflation pressure, once the proper tire pressure has been set, the TPM system warning will reset automatically when the vehicle has been driven for at least 2 minutes at or above 15 mph (24 km/h).

CHECK TPM SYSTEM

See your authorized dealer when this message appears in the EVIC. This message indicates that a system fault condition has been detected.

CAUTION!

The TPM system has been optimized for the original equipment tires and wheels. TPM system pressures have been established for the tire size equipped on your vehicle. Undesirable system operation or sensor damage may result when using replacement equipment that is not of the same size, type, and/or style. After-market wheels can cause sensor damage. Do not use tire sealant from a can, or balance beads if your vehicle is equipped with a TPM system, as damage to the sensors may result.

CAUTION!

After inspecting or adjusting the tire pressure always reinstall the valve stem cap. This will prevent moisture and dirt from entering the valve stem, which could damage the wheel rim sensor.

NOTE:

- The TPM system can inform the driver of a low tire pressure condition.
- The TPM system is not intended to replace normal tire care and maintenance, nor to provide warning of a tire failure or condition.
- The TPM system should not be used as a tire pressure gauge while adjusting your tire pressure.

General Information

This device complies with part 15 of the FCC rules and RSS 210 of Industry Canada. Operation is subject to the following conditions:

- This device may not cause harmful interference.
- This device must accept any interference received, including interference that may cause undesired operation.

The tire pressure sensors are covered under one of the following licenses:

United States KR5S120123
 Canada 2671-S120123

TIRE CHAINS

Certain models have sufficient tire-to-body clearance to allow use of tire chains. **Install chains on rear tires only.** Follow these recommendations to guard against damage and excessive tire and chain wear:

- Do not install tire chains or traction devices on vehicles with larger than P235/65R17 size tires. Tires larger than this may not provide sufficient body clearance with chains or other traction devices.
- Use SAE class "S" tire chains or traction devices only.
- Follow tire chain manufacturer's instructions for mounting chains.
- Install chains snugly and tighten after 1/2 mile (1 km) of driving.
- **Do not** exceed 35 mph (56 km/h), unless otherwise specified by the chain manufacturer.
- Drive cautiously, avoiding large bumps, potholes and extreme driving maneuvers.

TIRE ROTATION RECOMMENDATIONS

Tires on the front and rear axles of vehicles operate at different loads and perform different steering, handling, and braking functions. For these reasons, they wear at unequal rates, and develop irregular wear patterns.

These effects can be reduced by timely rotation of tires. The benefits of rotation are especially worthwhile with aggressive tread designs such as those on On/Off Road type tires. Rotation will increase tread life, help to maintain mud, snow, and wet traction levels, and contribute to a smooth, quiet ride.

Follow the recommended tire rotation frequency for your type of driving found in the "Maintenance Schedules" Section of this manual. More frequent rotation is permissible if desired. The reasons for any rapid or unusual wear should be corrected prior to rotation being performed.

NOTE: The Premium Tire Pressure Monitor System will automatically locate the pressure values displayed in the correct vehicle position following a tire rotation.

The suggested rotation method is the "forward-cross" shown in the following diagram.

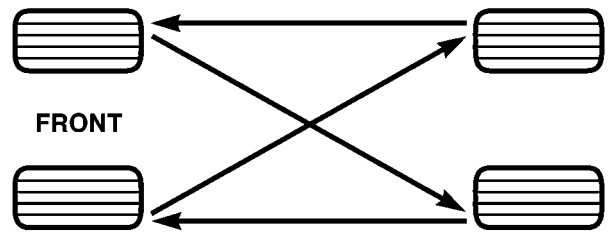

FUEL REQUIREMENTS

3.7/4.7L Engines (If Equipped)



All engines (except 5.7L engines) are designed to meet all emissions regulations and provide excellent fuel economy and performance when using high quality unleaded "regular" gasoline having an octane rating of 87. The use of premium gasoline is not recommended. Under normal conditions, the use of premium gasoline will not provide a benefit over high quality regular gasolines, and in some circumstances may result in poorer performance.

5.7L Engines (If Equipped)



The 5.7L engine is designed to meet all emissions regulations and provide satisfactory fuel economy and performance when

using high quality unleaded gasoline having an octane range of 87 to 89. The manufacturer recommends the use of 89 octane for optimum performance. The use of premium gasoline is not recommended. Under normal conditions, the use of premium gasoline will not provide a benefit over high quality regular and mid-grade gasolines, and in some circumstances may result in poorer performance.

Light spark knock at low engine speeds is not harmful to your engine. However, continued heavy spark knock at high speeds can cause damage and immediate service is required.

Poor quality gasoline can cause problems such as hard starting, stalling and hesitations. If you experience these symptoms, try another brand of gasoline before considering service for the vehicle.

Over 40 auto manufacturer's world wide have issued and endorsed consistent gasoline specifications (the World-wide Fuel Charter, WWFC) to define fuel properties necessary to deliver enhanced emissions, performance, and durability for your vehicle. The manufacturer recommends the use of gasoline that meets the WWFC specifications if they are available.

Reformulated Gasoline

Many areas of the country require the use of cleaner burning gasoline referred to as Reformulated Gasoline. Reformulated gasoline contains oxygenates, and is specifically blended to reduce vehicle emissions and improve air quality.

The manufacturer strongly supports the use of reformulated gasoline. Properly blended reformulated gasoline will provide excellent performance and durability for the engine and fuel system components.

Gasoline/Oxygenate Blends

Some fuel suppliers blend unleaded gasoline with oxygenates such as 10% ethanol, MTBE, and ETBE. Oxygenates are required in some areas of the country during the winter months to reduce carbon monoxide emissions. Fuels blended with these oxygenates may be used in your vehicle.

CAUTION!

DO NOT use gasoline containing METHANOL. Gasoline containing methanol may damage critical fuel system components.

MMT In Gasoline

MMT is a manganese containing metallic additive that is blended into some gasoline to increase octane. Gasoline blended with MMT provides no performance advantage beyond gasoline of the same octane number without MMT. Gasoline blended with MMT reduces spark plug life and reduces emission system performance in some vehicles. The manufacturer recommends that gasoline without MMT be used in your vehicle. The MMT content of gasoline may not be indicated on the gasoline pump, therefore, you should ask your gasoline retailer whether or not his/her gasoline contains MMT.

It is even more important to look for gasoline without MMT in Canada because MMT can be used at levels higher than allowed in the United States. MMT is prohibited in Federal and California reformulated gasoline.

Materials Added To Fuel

All gasoline sold in the United States is required to contain effective detergent additives. Use of additional detergents or other additives is not needed under normal conditions.

Fuel System Cautions**CAUTION!**

Follow these guidelines to maintain your vehicle's performance:

- The use of leaded gas is prohibited by Federal law. Using leaded gasoline can impair engine performance, damage the emission control system.

- An out-of-tune engine, or certain fuel or ignition malfunctions, can cause the catalytic converter to overheat. If you notice a pungent burning odor or some light smoke, your engine may be out of tune or malfunctioning and may require immediate service. Contact your dealer for service assistance.
- The use of fuel additives which are now being sold as octane enhancers is not recommended. Most of these products contain high concentrations of methanol. Fuel system damage or vehicle performance problems resulting from the use of such fuels or additives is not the responsibility of the manufacturer.

NOTE: Intentional tampering with emissions control systems can result in civil penalties being assessed against you.

Carbon Monoxide Warnings

WARNING!

Carbon monoxide (CO) in exhaust gases is deadly. Follow the precautions below to prevent carbon monoxide poisoning:

- Do not inhale exhaust gases. They contain carbon monoxide, a colorless and odorless gas which can kill. Never run the engine in a closed area, such as a garage, and never sit in a parked vehicle with the engine running for an extended period. If the vehicle is stopped in an open area with the engine running for more than a short period, adjust the ventilation system to force fresh, outside air into the vehicle.

- Guard against carbon monoxide with proper maintenance. Have the exhaust system inspected every time the vehicle is raised. Have any abnormal conditions repaired promptly. Until repaired, drive with all side windows fully open.
- Keep the liftgate closed when driving your vehicle to prevent carbon monoxide and other poisonous exhaust gases from entering the vehicle.

FUEL TANK FILLER CAP (GAS CAP)

The fuel cap is located on the left side of the vehicle. If the fuel cap is lost or damaged, be sure the replacement cap is for use with this vehicle.

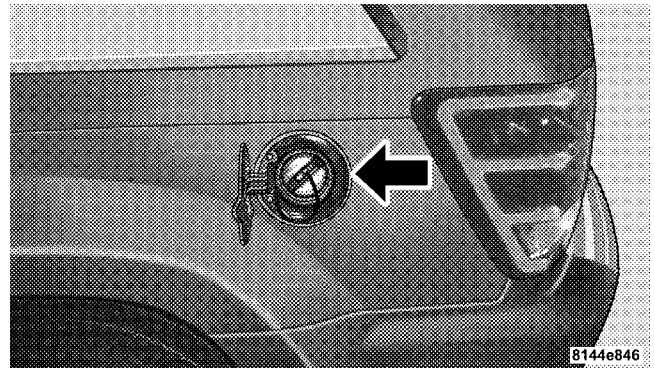

Fuel Filler Cap Location

CAUTION!

Damage to the fuel system or emission control system could result from using an improper fuel cap (gas cap). A poorly fitting cap could let impurities into the fuel system. Also, a poorly fitting aftermarket cap can cause the MIL (Malfunction Indicator Light) to illuminate, due to fuel vapors escaping from the system.

- Turn the engine off.
- Rotate the fuel cap to the left to remove.
- To replace the cap, insert it into the filler neck and tighten the cap about 1/4 turn until you hear one click. This is an indication that the cap is properly tightened.
- Make sure that the fuel cap tether strap is not caught under the fuel cap.

CAUTION!

To avoid fuel spillage and overfilling, do not “top off” the fuel tank after filling.

NOTE: When the fuel nozzle “clicks” or shuts off, the fuel tank is full.

Loose Fuel Filler Cap Message

If the vehicle diagnostic system determines that the fuel filler cap is loose, improperly installed, or damaged, a “CHECK GAS CAP” message will be displayed in the EVIC (Electronic Vehicle Information Center). Refer to “Electronic Vehicle Information Center” in Section 4 of this manual. Tighten the fuel filler cap properly and press the odometer reset button to turn the message off. If the problem continues, the message will appear the next time the vehicle is started. Refer to “Onboard Diagnostic System — OBDII” in Section 7 of this manual for more information.

WARNING!

- Remove the fuel cap (gas cap) slowly to prevent fuel spray from the filler neck which may cause injury.
- The volatility of some gasoline may cause a buildup of pressure in the fuel tank that may increase while you drive. This pressure can result in a spray of gasoline and/or vapors when the cap is removed from a hot vehicle. Removing the cap slowly allows the pressure to vent and prevents fuel spray.
- Never have any smoking materials lit in or near the vehicle when the fuel cap is removed or the tank filled.
- Never add fuel to the vehicle when the engine is running.

WARNING!

A fire may result if gasoline is pumped into a portable container that is inside of a vehicle. You could be burned. Always place gas containers on the ground while filling.

TRAILER TOWING

In this section you will find information on limits to the type of towing you can reasonably do with your vehicle. And you will find safety tips. Before towing a trailer carefully review this information to tow your load as efficiently and safely as possible.

To maintain warranty coverage, follow the requirements and recommendations in this manual concerning vehicles used for trailer towing.

Perform maintenance services as prescribed in the appropriate "Maintenance Schedule." Refer to Section 8 of this

manual. When your vehicle is used for trailer towing, never exceed the gross axle weight rating (GAWR) by the addition of:

- The tongue weight of the trailer.
- The weight of any other type of cargo or equipment put in or on your vehicle.

WARNING!

Improper towing can lead to an injury accident. Follow these guidelines to make your trailer towing as safe as possible:

- Be sure a trailer is loaded heavier in front, about 10% to 15% of gross trailer weight. Loads balanced over the wheels or heavier in the rear cause the trailer to sway **severely** side to side which will cause loss of control of

the vehicle and trailer. Failure to load trailers heavier in front is the cause of many trailer related accidents.

- Do **not** interconnect the hydraulic brake system of your vehicle with that of the trailer. This could cause inadequate braking and possible personal injury.
- **Trailer brakes are required for trailers in excess of 2,000 lbs (907 kg).**
- Do **not** connect a trailer lighting system directly to the lighting system of your vehicle. Use an approved trailer wiring harness. Failure to do so could damage the vehicle electrical system and/or result in personal injury.
- When hauling cargo or towing a trailer, **do not** overload your vehicle or trailer. Overloading can cause a loss of control, poor performance or damage to brakes, axle, engine, transmission, steering, suspension, body structure or tires.

- Make certain that the load is secured in the trailer and will not shift during travel.
- It is recommended that **any** hitches installed on your vehicle be factory installed, or installed by a dealer using factory approved parts. Factory approved parts are specifically engineered with your vehicle's performance in mind, including the possibility that it will be involved in an accident. Other hitches may not have been so engineered. Vehicle performance, including vehicle damage in an accident situation, may therefore be different.
- If trailer towing is required and your vehicle is not equipped with a trailer tow package, the Mopar® accessory towing harnesses are the only approved method to provide for trailer lights. These harnesses are designed to provide current to the trailer lights but bypass the module designed to monitor tail lights. Refer to the package instructions for details.

Trailer and Tongue Weight

Gross Trailer Weight (GTW) means the weight of the trailer plus the weight of all cargo, consumables and equipment loaded on the trailer when in actual under-way towing condition. The best way to measure GTW is to put your fully loaded trailer on a vehicle scale. The entire weight of the trailer must be supported by the scale.

Always load a trailer with 60% of the cargo weight in the front of the trailer. This places approximately 10% to 15% of the GTW on the tow hitch of your vehicle. This portion of the GTW becomes the tongue weight.

Trailer sway control and equalizing hitch are required for tongue weights above 350 lbs (159 kg), i.e., trailer weights heavier than 3,500 lbs (1 587 kg).

Trailer Tow Wiring

The Trailer Tow Package includes a 4 and 7 pin wiring harness located at the rear underbody of the vehicle.

NOTE: Connect trailer lighting and brakes using factory harnesses only. Do not cut or splice wiring to the brake circuits.

The electrical connections are all complete to the vehicle but you must mate the harness to a trailer connector. Refer to the following illustrations.

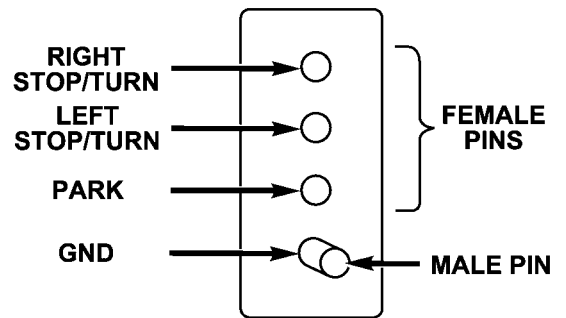

4-Pin Connector

813262be

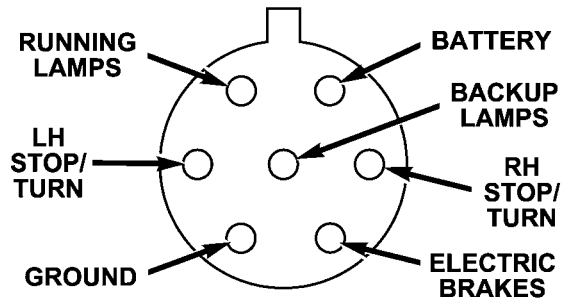

7-Pin Connector

812634c6

Cooling System Tips—Trailer Towing

To reduce potential for engine and transmission overheating in high ambient conditions, take the following actions:

- *City Traffic*

When stopped, put transmission in N (Neutral) and increase engine idle speed.

- *Highway Driving*

Reduce speed.

- *Air Conditioning*

Turn off temporarily.

To reduce the potential for transmission overheating, turn the "TOW/HAUL" feature on when driving in hilly areas or downshift the transmission to the next lower gear range to eliminate excessive transmission shifting. This action will also reduce the possibility of transmission overheating and provide better engine braking.

TRAILER CLASSIFICATIONS

Class	Max. GTW (Gross Trailer Wt.)	Frontal Area	Length
Class I - Light Duty	2,000 lbs. (907 kg)	32 ft ²	20 ft
Class II - Medium Duty	3,500 lbs. (1 587 kg)	40 ft ²	20 ft
Class III - Heavy Duty	5,000 lbs. (2 268 kg)	60 ft ²	25 ft
Class IV - Extra Heavy Duty	(See Note 1)	60 ft ²	30 ft

Note 1 – Refer to the Trailer Towing Capability chart for the Max. GTW towable for a given drivetrain.

TRAILER TOWING CAPABILITY

Engine	Model	GVWR (Gross Vehicle Wt. Rating)	GCWR (Gross Combined Wt. Rating)	Hitch Type	Max. GTW (Gross Trailer Wt.)	Max. Tongue Wt. (See Note 1)
3.7L	4x2	5,700 lbs (2 585 kg)	8,000 lbs (3 629 kg)	Class II	3,500 lbs (1 587 kg)	525 lbs (238 kg)
3.7L	4x4	5,900 lbs (2 676 kg)	8,200 lbs (3 719 kg)	Class II	3,500 lbs (1 587 kg)	525 lbs (238 kg)
4.7L	4x2	6,010 lbs (2 726 kg)	11,200 lbs (5 080 kg)	Class IV	6,500 lbs (2 948 kg)	720 lbs (327 kg)
4.7L	4x4	6,100 lbs (2 767 kg)	11,450 lbs (5 194 kg)	Class IV	6,500 lbs (2 948 kg)	720 lbs (327 kg)
5.7L	4x4	6,150 lbs (2 789 kg)	12,200 lbs (5 534 kg)	Class IV	7,200 lbs (3 266 kg)	720 lbs (327 kg)

Note 1 – The towing vehicle payload should be reduced by the tongue load (for a dead weight hitch) to keep the rear axle loading below GAWR (Gross Axle Weight Rating) of 3,200 lbs (1 451 kg).

RECREATIONAL TOWING (BEHIND MOTORHOME, ETC.)

Towing – 2WD Models

Recreational towing is allowed **ONLY** if the driveshaft is removed. Towing with the rear wheels on the ground while the driveshaft is connected can result in severe transmission damage which is not covered under the Limited Warranty.

Towing — Quadra-Trac I (Single-Speed Transfer Case) 4WD Models

Recreational towing is not allowed. This model does not have a N (Neutral) position in the transfer case.

Towing — Quadra-Trac II /Quadra-Drive II 4WD Models

CAUTION!

Internal damage to the transfer case will occur if a front or rear wheel lift is used when recreational towing.

NOTE: The transfer case must be in the N (Neutral) position, and the transmission must be in the P (Park) position for recreational towing.

Shifting Into Neutral (N)

Use the following procedure to prepare your vehicle for recreational towing.

CAUTION!

It is necessary to follow these steps to be certain that the transfer case is fully in N (Neutral) before recreational towing to prevent damage to internal parts.

1. Depress brake pedal.
2. Shift transmission into N (Neutral).
3. Shift transfer case lever into N (Neutral). Refer to "Four-Wheel Drive Operation" in this section. Start engine.
4. Shift transmission into D (Drive).
5. Release brake pedal and ensure that there is no vehicle movement.

6. Shut the engine OFF and place the ignition key into the unlocked OFF position.
7. Shift transmission into P (Park).
8. Apply parking brake.
9. Attach vehicle to the tow vehicle with tow bar.
10. Release parking brake.

CAUTION!

Transmission damage may occur if the transmission is shifted into P (Park) with the transfer case in N (Neutral) and the engine running. With the transfer case in N (Neutral) ensure that the engine is OFF prior to shifting the transmission into P (Park) (refer to steps 7 – 8 above).

Shifting Out Of Neutral (N)

Use the following procedure to prepare your vehicle for normal usage.

1. Turn the ignition key to the unlocked OFF position.
2. Shift transmission into N (Neutral).
3. Shift transfer case lever to desired position. Refer to "Four-Wheel Drive Operation" in this section.
4. Shift transmission into P (Park).
5. Start the engine.
6. Shift transmission into D (Drive).

NOTE: When shifting out of transfer case N (Neutral), turning the engine OFF may be required to avoid gear clash.

WARNING!

You or others could be injured if you leave the vehicle unattended with the transfer case in the N (Neutral) position without first fully engaging the parking brake. The transfer case N (Neutral) position disengages both the front and rear driveshafts from the powertrain and will allow the vehicle to move regardless of the transmission position. The parking brake should always be applied when the driver is not in the vehicle.

CAUTION!

Do not use a bumper mounted clamp-on tow bar on your vehicle. The bumper face bar will be damaged.

SNOW PLOW

Snow plows, winches, and other aftermarket equipment should **not** be added to the front end of your vehicle. The airbag crash sensors may be affected by the change in the front end structure. The airbags could deploy unexpectedly or could fail to deploy during a collision.

WARNING!

Do not add a snow plow, winches, or any other aftermarket equipment to the front of your vehicle. This could adversely affect the functioning of the airbag system and you could be injured.

WHAT TO DO IN EMERGENCIES

CONTENTS

■ Hazard Warning Flashers	296	□ Jacking Instructions	300
■ If Your Engine Overheats	297	■ Jump Starting Procedure	303
■ Jacking And Tire Changing	298	■ Emergency Tow Hooks — If Equipped	305
□ Jack Location	298	■ Towing A Disabled Vehicle	306
□ Spare Tire Stowage	299	□ 2WD Models Only	306
□ Spare Tire Removal	299	□ 4WD Models Only	306
□ Preparations For Jacking	300		

HAZARD WARNING FLASHERS

Your vehicle's hazard warning flasher is an emergency warning system. When you activate it, all front and rear directional signals will flash intermittently. Use it when your vehicle is disabled on or near the road. It warns other drivers to steer clear of you and your vehicle. This is an emergency warning system, not to be used when the vehicle is in motion.

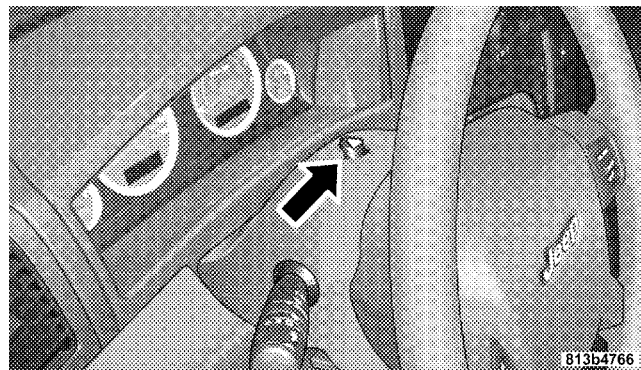

Hazard Warning Switch

To activate the warning flasher, push down on the button on top of the steering column until it latches. To turn the warning flasher off, push down again to unlatch the button.

NOTE: With extended use, the flasher may run down your battery.

IF YOUR ENGINE OVERHEATS

In any of the following situations, you can reduce the potential for overheating by taking the appropriate action.

- On the highways — Slow down.
- In city traffic — While stopped, put transmission in N (Neutral), but do not increase engine idle speed.

NOTE: There are steps that you can take to slow down an impending overheat condition. If your air conditioner is on, turn it off. The air conditioning system adds heat to the engine cooling system and turning off the A/C removes this heat. You can also turn the Temperature Control to maximum heat, the Mode Control to floor, and the Fan Control to High. This allows the heater core to act as a supplement to the radiator and aids in removing heat from the engine cooling system.

CAUTION!

Driving with a hot cooling system could damage your vehicle. If the temperature gauge reads "H", pull over and stop the vehicle. Idle the vehicle with the air conditioner turned off until the pointer drops back into the normal range. If the pointer remains on the "H", and you hear continuous chimes, turn the engine off immediately, and call for service.

JACKING AND TIRE CHANGING

WARNING!

- Getting under a jacked-up vehicle is dangerous. The vehicle could slip off the jack and fall on you. You could be crushed. Never get any part of your body under a vehicle that is on a jack. If you need to get under a raised vehicle, take it to a service center where it can be raised on a lift.
- The jack is designed to use as a tool for changing tires only. The jack should not be used to lift the vehicle for service purposes. The vehicle should be jacked on a firm level surface only. Avoid ice or slippery areas.

Jack Location

The scissor-type jack and tire changing tools are located in a compartment behind the second row seat.

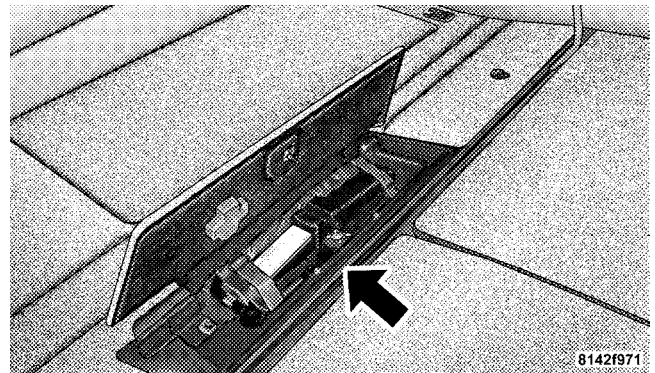

Jack Storage Location

Spare Tire Stowage

The spare tire is stowed under the rear of the vehicle by means of a cable winch mechanism. To remove or stow the spare, use the jack handle to rotate the "spare tire drive" nut. The nut is located under a plastic cover at the center-rear of the cargo floor area, just inside the liftgate opening.

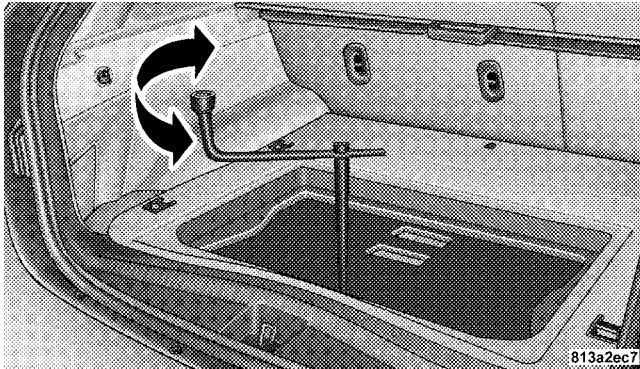

Lowering/Raising Spare

Spare Tire Removal

Fit the jack handle extension over the drive nut. Use the Lug Wrench to rotate the nut counter clockwise until the spare is on the ground with enough slack in the cable to allow to pull the tire out from under the vehicle.

CAUTION!

The winch mechanism is designed for use with the jack extension tube only. Use of an air wrench or other power tools is not recommended and can damage the winch.

When the spare is clear, tilt the retainer at the end of the cable and pull it through the center of the wheel.

Preparations For Jacking

Park the vehicle on a firm level surface, avoid ice or slippery areas, **set the parking brake** and place the gear selector in P (Park). Turn OFF the ignition.

WARNING!

Do not attempt to change a tire on the side of the vehicle close to moving traffic. Pull far enough off the road to avoid being hit when operating the jack or changing the wheel.

- Turn on the Hazard Warning Flasher.

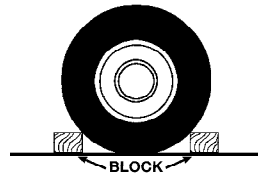

- Block both the front and rear of the wheel diagonally opposite of the jacking position. For example, if changing the right front tire, block the left rear wheel.

- Passengers should not remain in the vehicle when the vehicle is being jacked.

Jacking Instructions

1. Remove the spare tire, jack, and tools from storage.
2. Loosen (but do not remove) the wheel lug nuts by turning them to the left one turn while the wheel is still on the ground.

3. Assemble the jack and jacking tools as shown. Connect jack handle driver (A) to two extensions (B), then to the lug wrench (C).

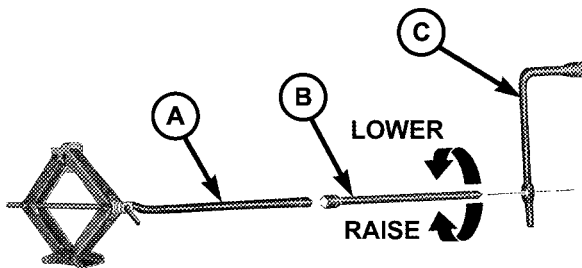

8107e507

4. Locate the jack as shown. For the front axle, place it under the front lower control arm as shown. For the rear axle, place it under the axle near the wheel to be changed.

Ensure the jack is closest to the inside of the wheel when jacking on the rear axle. **Do not raise the vehicle until you are sure the jack is fully engaged.**

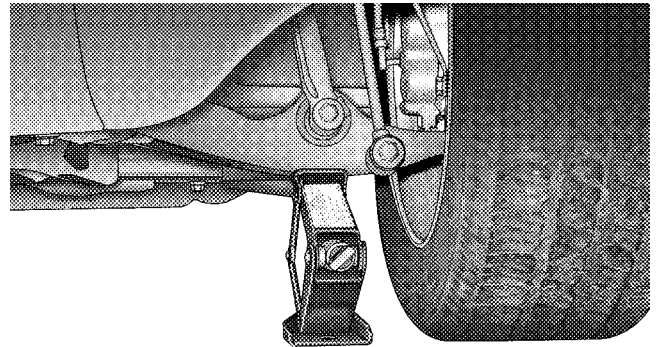

8141842b

Front Jacking Location

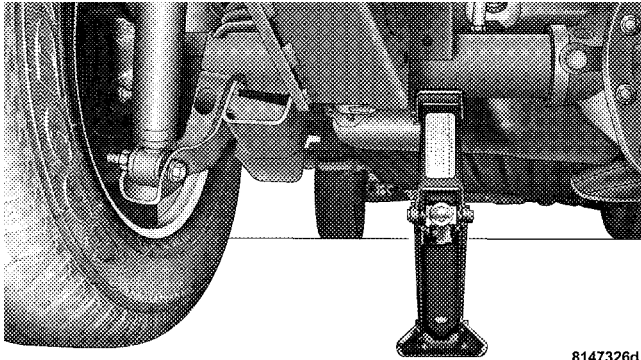

8147326d

Rear Jacking Location

5. Raise the vehicle by turning the jack screw clockwise. Raise the vehicle only until the tire just clears the surface and enough clearance is obtained to install the spare tire. Minimum tire lift provides maximum stability.

WARNING!

Raising the vehicle higher than necessary can make the vehicle less stable. It could slip off the jack and hurt someone near it. Raise the vehicle only enough to remove the tire.

6. Remove the lug nuts and wheel.
7. Position the spare wheel/tire on the vehicle and install the lug nuts with the cone-shaped end toward the wheel. Lightly tighten the nuts. To avoid the risk of forcing the vehicle off the jack, do not tighten the nuts fully until the vehicle has been lowered.
8. Lower the vehicle by turning the jack screw counter clockwise, and remove the jack and wheel blocks.
9. Finish tightening the lug nuts. Push down on the wrench while tightening for increased leverage. Alternate

nuts until each nut has been tightened twice. Correct wheel nut tightness is 130 N·m (95 ft. lbs). If in doubt about the correct tightness, have them checked with a torque wrench by your authorized dealer or at a service station.

10. Lower the jack to its fully closed position.

WARNING!

A loose tire or jack, thrown forward in a collision or hard stop could endanger the occupants of the vehicle. Always stow the jack parts and the spare tire in the places provided.

11. Secure the tire, jack, and tools in their proper locations.

NOTE: Tire should be stowed with the “beauty” side up. Storing the tire upside down may result in scratching

or damage to the wheel face. Continue winching up the tire until you hear the winch “ratchet” three times. Double check to ensure the tire is snug against the underbody of the vehicle. Damage to the winch cable may result if the vehicle is driven with the tire loose.

12. Reinstall the rubber plug into the floor of the cargo area.

JUMP STARTING PROCEDURE

NOTE: Check the test indicator on top of battery for battery fluid level. If the indicator is clear, the level is low. Add water to the proper level and reinstall the vent caps before attempting to jump start the vehicle.

1. Wear eye protection and remove any metal jewelry such as watch bands or bracelets that might make an unintended electrical contact.

2. When boost is provided by a battery in another vehicle, park that vehicle within booster cable reach but

without letting the vehicles touch. Set the parking brake, place the transmission in P (Park), and turn the ignition to OFF for both vehicles.

3. Turn off the heater, radio and all unnecessary electrical loads.

4. Connect one end of a jumper cable to the positive terminal of the discharged battery. Connect the other end of the same cable to the positive terminal of the booster battery.

5. Connect the other cable, first to the negative terminal of the booster battery and then connect the other end to a non-paint metal surface on the engine of the vehicle with the discharged battery. Make sure you have a good contact on the engine.

6. Start the engine in the vehicle which has the booster battery, let the engine idle a few minutes, then start the engine in the vehicle with the discharged battery.

7. When removing the jumper cables, reverse the above sequence exactly. Be careful of the moving belts and fan.

NOTE: To start the vehicle following connection of a booster battery, the Security Alarm System must first be disabled by cycling a front door key cylinder or by using the keyless entry transmitter.

WARNING!

Jump starting can be dangerous. To avoid personal injury or damage to electrical components in vehicle, observe the following warnings:

- Battery fluid is a corrosive acid solution and can burn or even blind you. Don't allow battery fluid to contact your eyes, skin, or clothing. Don't lean over a battery

when attaching clamps. If acid splashes in eyes or on skin, flush the area immediately with large amounts of water.

- Do not use a booster battery or any other booster source that has a greater than 12-volt system, i.e., do not use a 24-volt power source.
- Never attempt to jump start a discharged battery that is frozen, because it could rupture or explode during jump starting.
- Be sure your vehicle is not touching the jump start vehicle.
- Observe all Battery Warnings in Section 7 of this manual, while jump starting your vehicle.

WARNING!

Do not attempt to push or tow your vehicle to get it started. Unburned fuel could enter the catalytic converter and, once the engine has started, ignite and damage the converter and vehicle.

EMERGENCY TOW HOOKS — IF EQUIPPED

If your vehicle is equipped with tow hooks, there will be one in the rear and two mounted on the front of the vehicle. The rear hook will be located on the driver's side of the vehicle.

NOTE: For off-road recovery, it is recommended to use both of the front tow hooks to minimize the risk of damage to the vehicle.

CAUTION!

Tow hooks are for emergency use only, to rescue a vehicle stranded off road. Do not use tow hooks for tow truck hookup or highway towing. You could damage your vehicle.

WARNING!

Stand clear of vehicles when pulling with tow hooks. Tow straps and chains may break, causing serious injury.

TOWING A DISABLED VEHICLE**2WD Models Only**

Provided the transmission is operable, tow only in N (Neutral) at speeds not exceeding 30 mph (48 km/h), for distances of not more than 15 miles (24 km). Towing at more than 30 mph (48 km/h) or for more than 15 miles (24 km) can cause severe transmission damage. If the transmission is not operable, or the vehicle must be towed faster than 30 mph (48 km/h) or farther than 15 miles (24 km), remove the driveshaft or tow with all four wheels **OFF** the ground. Acceptable methods are to tow the vehicle on a flatbed or with one end of the vehicle raised and the other end on a towing dolly.

4WD Models Only

The manufacturer recommends towing with all four wheels **OFF** the ground. Acceptable methods are to tow the vehicle on a flatbed or with one end of the vehicle raised and the other end on a towing dolly.

MAINTAINING YOUR VEHICLE

CONTENTS

■ 3.7L Engine	310	■ Maintenance Procedures	316
■ 4.7L Engine	311	□ Engine Oil	316
■ 5.7L Engine	312	□ Drive Belts - Check Condition And Tension . . .	320
■ Onboard Diagnostic System — OBD II	313	□ Spark Plugs	321
□ Loose Fuel Filler Cap Message	313	□ Catalytic Converter	321
■ Emissions Inspection And Maintenance Programs	314	□ Ignition Cables	323
■ Replacement Parts	315	□ Crankcase Emission Control System	323
■ Dealer Service	316	□ Fuel Filter	323
		□ Air Cleaner Filter	323

308 MAINTAINING YOUR VEHICLE

□ Maintenance-Free Battery	324	□ Appearance Care And Protection From Corrosion	340
□ Air Conditioner Maintenance	325	■ Fuse Panel	345
□ Power Steering Fluid Check	326	□ Interior Fuses	345
□ Body Lubrication	327	□ Underhood Fuses (Power Distribution Center)	346
□ Windshield Wiper Blades	327	□ Underhood Fuses (Integrated Power Module)	348
□ Windshield Washers — Front And Rear	328	■ Vehicle Storage	350
□ Exhaust System	328	■ Replacement Bulbs	350
□ Cooling System	329	■ Bulb Replacement	351
□ Hoses And Vacuum/Vapor Harnesses	334	□ Head Light	351
□ Brake System	334	□ Front Turn Signal	353
□ Automatic Transmission	336	□ Front Fog Light	354
□ Transfer Case	339		
□ Front/Rear Axle Fluid	340		

<input type="checkbox"/> Rear Tail, Stop, Turn Signal, And Back-Up Lights	355	<input checked="" type="checkbox"/> Recommended Fluids, Lubricants And Genuine Parts	358
<input type="checkbox"/> Center High Mounted Stop Light (CHMSL)	356	<input type="checkbox"/> Engine	358
<input checked="" type="checkbox"/> Fluid Capacities	357	<input type="checkbox"/> Chassis	359

3.7L ENGINE

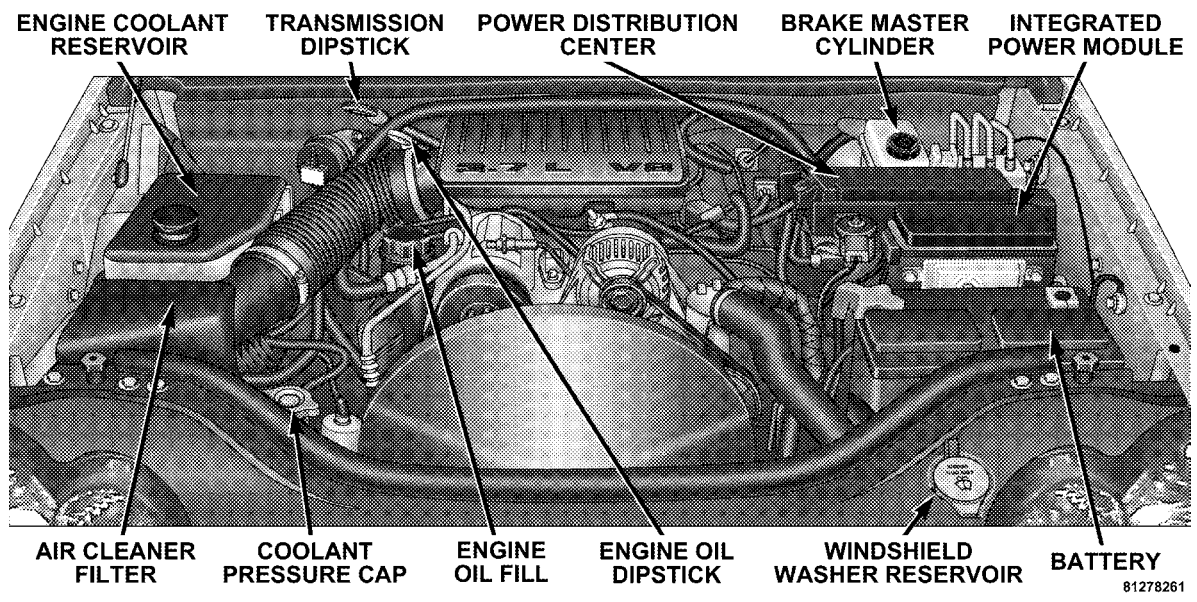

81278261

4.7L ENGINE

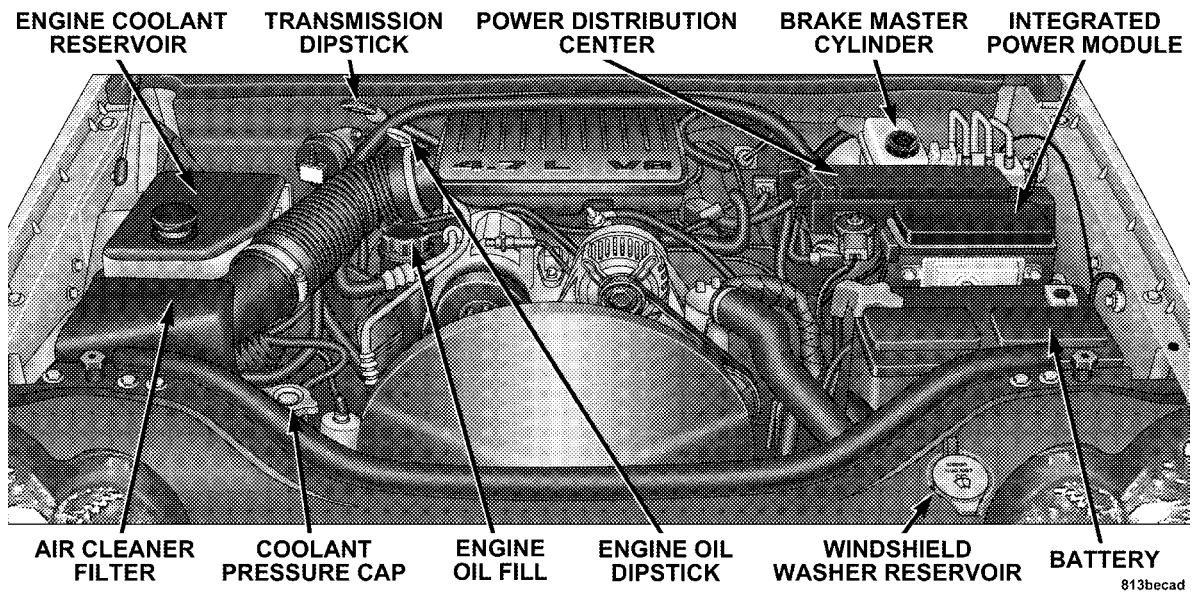

5.7L ENGINE

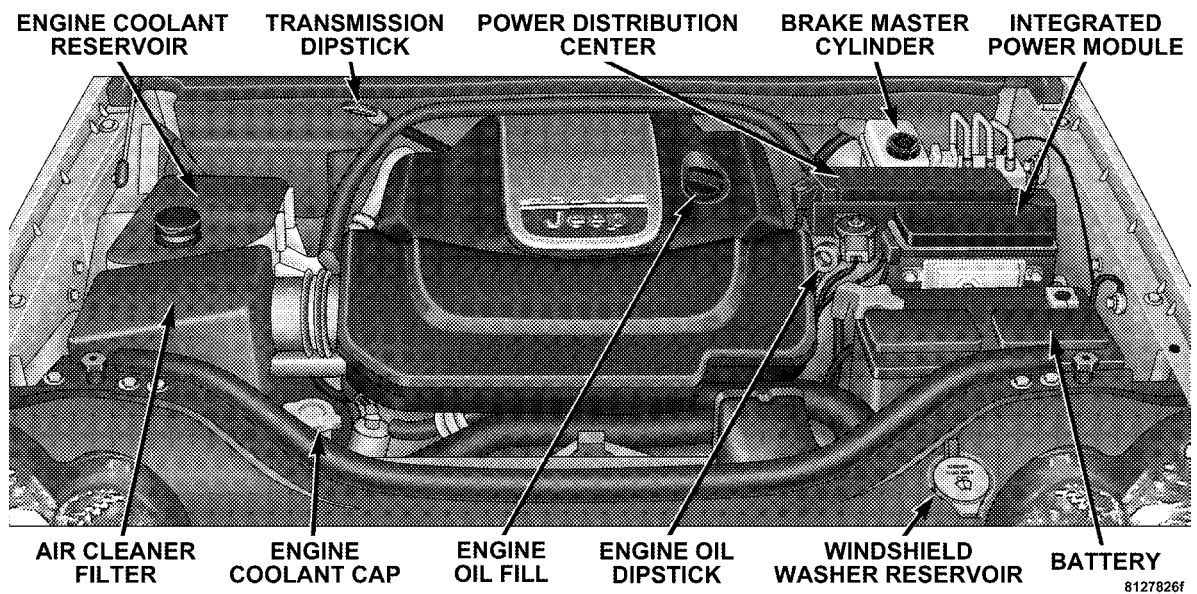

ONBOARD DIAGNOSTIC SYSTEM — OBD II

Your vehicle is equipped with a sophisticated onboard diagnostic system called OBD II. This system monitors the performance of the emissions, engine, and automatic transmission control systems. When these systems are operating properly, your vehicle will provide excellent performance and fuel economy, as well as engine emissions well within current government regulations.

If any of these systems require service, the OBD II system will turn on the “Malfunction Indicator Light.” It will also store diagnostic codes and other information to assist your service technician in making repairs. Although your vehicle will usually be drivable and not need towing, see your dealer for service as soon as possible.

CAUTION!

- Prolonged driving with the “Malfunction Indicator Light” on could cause further damage to the emission control system. It could also affect fuel economy and driveability. The vehicle must be serviced before any emissions tests can be performed.
- If the “Malfunction Indicator Light” is flashing while the engine is running, severe catalytic converter damage and power loss will soon occur. Immediate service is required.

Loose Fuel Filler Cap Message

After fuel is added, the vehicle diagnostic system can determine if the fuel filler cap is loose, improperly installed, or damaged. A loose fuel filler cap message will be displayed in the instrument cluster. Tighten the gas

cap until a "clicking" sound is heard. This is an indication that the gas cap is properly tightened. Press the odometer reset button to turn the message off. If the problem persists, the message will appear the next time the vehicle is started. This might indicate a damaged cap. If the problem is detected twice in a row, the system will turn on the Malfunction Indicator Light (MIL). Resolving the problem will turn the MIL light off.

EMISSIONS INSPECTION AND MAINTENANCE PROGRAMS

In some localities, it may be a legal requirement to pass an inspection of your vehicle's emissions control system. Failure to pass could prevent vehicle registration.



For states which have an I/M (Inspection and Maintenance) requirement, this check verifies the following: the MIL (Malfunction Indicator Lamp)

is functioning and is not on when the engine is running, and that the OBD (On Board Diagnostic) system is ready for testing.

Normally, the OBD system will be ready. The OBD system may **not** be ready if your vehicle was recently serviced, if you recently had a dead battery, or a battery replacement. If the OBD system should be determined not ready for the I/M test, your vehicle may fail the test.

Your vehicle has a simple ignition key actuated test which you can use prior to going to the test station. To check if your vehicle's OBD system is ready, you must do the following:

1. Insert your ignition key into the ignition switch.
2. Turn the ignition to the ON position, but do not crank or start the engine.
3. If you crank or start the engine, you will have to start this test over.

4. As soon as you turn your key to the ON position, you will see your MIL symbol come on as part of a normal bulb check.

5. Approximately 15 seconds later, one of two things will happen:

- a. The MIL will flash for about 10 seconds and then return to being fully illuminated until you turn off the ignition key or start the engine. This means that your vehicle's OBD system is **not ready** and you should **not** proceed to the I/M station.
- b. The MIL will not flash at all and will remain fully illuminated until you turn off the ignition key or start the engine. This means that your vehicle's OBD system is **ready** and you can proceed to the I/M station.

If your OBD system is **not ready**, you should see your authorized dealer or repair facility. If your vehicle was recently serviced or had a battery failure or replacement,

you may need to do nothing more than drive your vehicle as you normally would in order for your OBD system to update. A recheck with the above test routine may then indicate that the system is now ready.

Regardless of whether your vehicle's OBD system is ready or not ready, if the MIL symbol is illuminated during normal vehicle operation, you should have your vehicle serviced before going to the I/M station. The I/M station can fail your vehicle because the MIL symbol is on with the engine running.

REPLACEMENT PARTS

Use of genuine Mopar® parts for normal/scheduled maintenance and repairs is highly recommended to insure the designed performance. Damage or failures caused by the use of non-Mopar® parts for maintenance and repairs will not be covered by the manufacturer's warranty.

DEALER SERVICE

Your dealer has the qualified service personnel, special tools and equipment to perform all service operations in an expert manner. Service Manuals are available which include detailed service information for your vehicle. Refer to these manuals before attempting any procedure yourself.

NOTE: Intentional tampering with emissions control systems can result in civil penalties being assessed against you.

WARNING!

You can be badly injured working on or around a motor vehicle. Do only that service work for which you have the knowledge and the proper equipment. If you have any doubt about your ability to perform a service job, take your vehicle to a competent mechanic.

MAINTENANCE PROCEDURES

The pages that follow contain the **required** maintenance services determined by the engineers who designed your vehicle.

Besides the maintenance items for which there are fixed maintenance intervals, there are other items that should operate satisfactorily without periodic maintenance. However, if a malfunction of these items does occur, it could adversely affect the engine or vehicle performance. These items should be inspected if a malfunction is observed or suspected.

Engine Oil**Checking Oil Level**

To assure proper engine lubrication, the engine oil must be maintained at the correct level. Check the oil level at regular intervals, such as every fuel stop.

The best time to check the engine oil level is about 5 minutes after a fully warmed engine is shut off or before starting the engine after it has sat overnight.

Checking the oil while the vehicle is on level ground will improve the accuracy of the oil level readings. Maintain the oil level in the SAFE level range. Adding 1 U.S. Quart (0.95L) of oil when the level is at the bottom of the SAFE range will result in the level being at the top of the SAFE range.

CAUTION!

Overfilling or underfilling the crankcase will cause aeration or loss of oil pressure. This could damage your engine.

Change Engine Oil

Road conditions as well as your kind of driving affect the interval at which your oil should be changed. Check the following to determine if any apply to you:

- Day or night temperatures are below 32°F (0°C)
- Stop and go driving
- Extensive engine idling
- Driving in dusty conditions
- Short trips of less than 10 miles (16.2 km)
- More than 50% of your driving is at sustained high speeds during hot weather, above 90°F (32°C)
- Trailer towing
- Taxi, Police, or delivery service (Commercial Service)
- Off road or desert operation
- If equipped for and operating with E-85 (ethanol) fuel

If **ANY** of these apply to you, then change your engine oil every 3,000 miles (5 000 km) or 3 months, whichever comes first, and follow the maintenance recommendations in “Maintenance Schedule B.”

If none of these apply to you, then change your engine oil every 6,000 miles (10 000 km) or 6 months, whichever comes first.

NOTE: Under no circumstances should oil change intervals exceed 6,000 miles (10 000 km) or 6 months whichever comes first.

Engine Oil Selection

For best performance and maximum protection for all engines under all types of operating conditions, the manufacturer recommends engine oils that are API Certified and meet the requirements of DaimlerChrysler Material Standard MS-6395. Use Mopar® or an equivalent oil meeting the specification MS-6395.

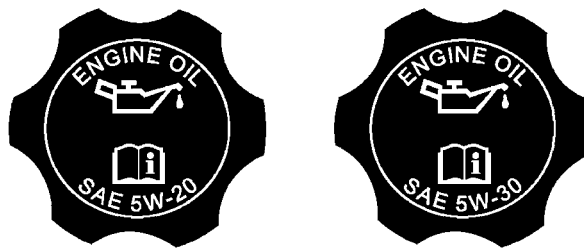

81364ec7

Oil Filler Caps

American Petroleum Institute (API) Engine Oil Identification Symbol



This symbol means that the oil has been certified by the American Petroleum Institute (API). The manufacturer only recommends API Certified engine oils that meet the requirements of DaimlerChrysler Material Standard MS-6395. Use Mopar® or an equivalent oil meeting the specifi-

cation MS-6395.

Engine Oil Viscosity (3.7L and 4.7L Engines)

SAE 5W-30 engine oil is recommended for all operating temperatures. This engine oil improves low temperature starting and vehicle fuel economy. Refer to your engine oil filler cap for the recommended engine oil viscosity for your vehicle.

Engine Oil Viscosity (5.7L Engines)

SAE 5W-20 engine oil is recommended for all operating temperatures. This engine oil improves low temperature starting and vehicle fuel economy. Refer to your engine oil filler cap for the recommended engine oil viscosity for your vehicle.

For information on engine oil filler cap location, see the Engine Compartment illustration in this section.

Lubricants which do not have both, the engine oil certification mark and the correct SAE viscosity grade number should not be used.

NOTE: Vehicles equipped with 5.7L engines must use 5W-20 oil. Failure to do so may result in improper operation of the Multiple Displacement System (MDS). Refer to "Multi Displacement System" in Section 5 of this manual.

Materials Added to Engine Oils

The manufacturer **strongly recommends** against the addition of any additives (other than leak detection dyes) to engine oil. Engine oil is an engineered product and its performance may be impaired by supplemental additives.

Disposing of Used Engine Oil

Care should be taken in disposing of the used engine oil from your vehicle. Used oil, indiscriminately discarded, can present a problem to the environment. Contact your local authorized dealer, service station, or governmental agency for advice on how and where used oil can be safely discarded in your area.

Engine Oil Filter

The engine oil filter should be replaced with a new filter at every oil change.

Engine Oil Filter Selection

All of the manufacturer's engines have a full-flow type disposable oil filter. Use a filter of this type for replacement. The quality of replacement filters varies considerably. Only high quality filters should be used to assure most efficient service. Mopar® engine oil filters are high quality oil filters and are recommended.

Drive Belts - Check Condition and Tension

At the mileages shown in the appropriate "Maintenance Schedule," check all drive belts for condition and proper tension. Improper belt tension can cause belt slippage and failure.

Inspect the drive belt for evidence of cuts, cracks, or glazing and replace them if there is any sign of damage which could result in belt failure. If adjustment is required, adjust the belts according to the specifications and procedures shown in the Service Manual.

Special tools are required to properly measure tension and to restore belt tension to factory specifications. Also, check belt routing to make sure there is no interference between the belts and other engine components.

Spark Plugs

Spark plugs must fire properly to assure engine performance and emission control. New spark plugs should be installed at the specified mileage. The entire set should be replaced if there is any malfunction due to a faulty spark plug. Refer to the "Vehicle Emission Control Information" label in the engine compartment for spark plug information.

Catalytic Converter

The catalytic converter requires the use of unleaded fuel only. Leaded gasoline will destroy the effectiveness of the converter as an emission control device.

Under normal operating conditions, the catalytic converter will not require maintenance. However, it is important to keep the engine properly tuned to assure proper catalyst operation and prevent possible catalyst damage.

CAUTION!

Damage to the catalytic converter can result if your vehicle is not kept in proper operating condition. In the event of engine malfunction, particularly involving engine misfire or other apparent loss of performance, have your vehicle serviced promptly. Continued operation of your vehicle with a severe malfunction could cause the converter to overheat, resulting in possible damage to the converter and vehicle.

WARNING!

A hot exhaust system can start a fire if you park over materials that can burn. Such materials might be grass or leaves coming into contact with your exhaust system. Do not park or operate your vehicle in areas where your exhaust system can contact anything that can burn.

In unusual situations involving grossly malfunctioning engine operation, a scorching odor may suggest severe and abnormal catalyst overheating. If this occurs, stop the vehicle, turn off the engine and allow it to cool. Service, including a tune up to manufacturer's specifications, should be obtained immediately.

To minimize the possibility of catalytic converter damage:

- Do not shut off the engine or interrupt the ignition when the transmission is in gear and the vehicle is in motion.
- Do not try to start the engine by pushing or towing the vehicle.
- Do not idle the engine with any spark plug wires disconnected or removed, such as when diagnostic testing.
- Do not idle the engine for prolonged periods during very rough idle or malfunctioning operating conditions.
- Do not allow vehicle to run out of fuel.

NOTE: Intentional tampering with emissions control systems can result in civil penalties being assessed against you.

Ignition Cables

Replace the ignition cables (5.7L engines only) at the mileage interval shown in the maintenance charts.

Crankcase Emission Control System

Proper operation of this system depends on freedom from sticking or plugging due to deposits. As vehicle mileage builds up, the PCV valve and passages may accumulate deposits. If a valve is not working properly, replace it with a new valve. **DO NOT ATTEMPT TO CLEAN THE OLD PCV VALVE!**

Check ventilation hose for indication of damage or plugging deposits. Replace if necessary.

Fuel Filter

A plugged fuel filter can cause hard starting or limit the speed at which a vehicle can be driven. Should an excessive amount of dirt accumulate in the fuel tank, frequent replacement of the fuel filter which is mounted in the fuel tank may be necessary.

Air Cleaner Filter

Under normal driving conditions, replace the air filter at the intervals shown on "Maintenance Schedule A." If, however, you drive the vehicle frequently under dusty or severe conditions, the filter element should be inspected periodically and replaced if necessary at the intervals shown on "Maintenance Schedule B."

WARNING!

The air cleaner can provide protection in the case of engine backfire. Do not remove the air cleaner unless it is necessary for repair or maintenance. Make sure that no one is near the engine compartment before starting the vehicle with the air cleaner removed. Failure to do so can result in serious personal injury.

Maintenance-Free Battery

Your vehicle is equipped with a maintenance-free battery. You will never have to add water, nor is periodic maintenance required.

WARNING!
Battery posts, terminals, and related accessories contain lead and lead compounds. Always wash hands after handling the battery.

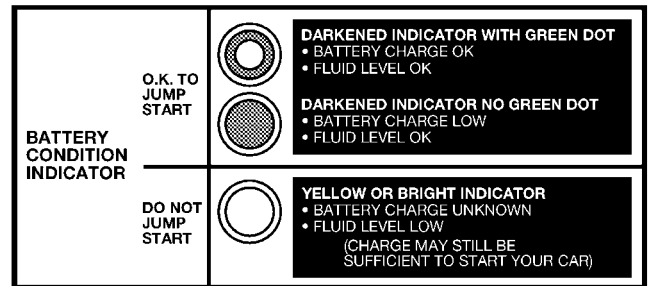

6000bce

To determine the battery charge, check the battery test indicator (if equipped) on top of the battery. Refer to the illustration.

CAUTION!

It is essential when replacing the cables on the battery that the positive cable is attached to the positive post and the negative cable is attached to the negative post. Battery posts are marked (+) positive and negative (-) and identified on the battery case. Also, if a "fast charger" is used while battery is in the vehicle, disconnect both vehicle battery cables before connecting the charger to battery. Do not use a "fast charger" to provide starting voltage.

Air Conditioner Maintenance

For best possible performance, your air conditioner should be checked and serviced by an Authorized Dealer at the start of each warm season. This service should include cleaning of the condenser fins and a performance test. Drive belt tension should also be checked at this time.

WARNING!

- Use only refrigerants and compressor lubricants approved by the manufacturer for your air conditioning system. Some unapproved refrigerants are flammable and can explode, injuring you. Other unapproved refrigerants or lubricants can cause the system to fail, requiring costly repairs. Refer to Section 3 of the Warranty Information Book for additional warranty information.
- The air conditioning system contains refrigerant under high pressure. To avoid risk of personal injury or damage to the system, adding refrigerant or any repair requiring lines to be disconnected should be done by an experienced repairman.

Refrigerant Recovery and Recycling

R-134a Air Conditioning Refrigerant is a hydrofluorocarbon (HFC) that is endorsed by the Environmental Protection Agency and is an ozone-saving product. However, the manufacturer recommends that air conditioning service be performed by dealers or other service facilities using recovery and recycling equipment.

Power Steering Fluid Check

Your new Grand Cherokee requires the use of a new Power Steering Fluid. This new fluid is specially formulated to ensure the long life of the power steering system.

The power steering system requires the use of Mopar® Hydraulic System Power Steering Fluid (P/N 05142893AA), or equivalent, which meets DaimlerChrysler Material Standard MS-10838.

CAUTION!

Do not use Automatic Transmission Fluid (ATF) or other types of power steering fluids when servicing the power steering system of this vehicle. Damage to the power steering system can result from the use of the wrong power steering fluid.

Checking the power steering fluid level at a defined service interval is not required. The fluid should only be checked if a leak is suspected, abnormal noises are apparent, and/or the system is not functioning as anticipated. Coordinate inspection efforts through a certified "DaimlerChrysler Dealership."

WARNING!

Fluid level should be checked on a level surface with the engine off to prevent injury from moving parts, and to insure accurate fluid level reading. Do not overfill. Use only the manufacturer's recommended fluid.

If necessary, add fluid to restore to the proper indicated level. With a clean cloth, wipe any spilled fluid from all surfaces. Refer to Recommended Fluids, Lubricants, and Genuine Parts for correct fluid type.

Body Lubrication

Locks and all body pivot points, including such items as seat tracks, doors, tailgate and hood hinges, should be lubricated periodically to assure quiet, easy operation and to protect against rust and wear. Prior to the application of any lubricant, the parts concerned should be

wiped clean to remove dust and grit; after lubricating excess oil and grease should be removed. Particular attention should also be given to hood latching components to insure proper function. When performing other underhood services, the hood latch, release mechanism and safety catch should be cleaned and lubricated.

The external lock cylinders should be lubricated twice a year, preferably in the fall and spring. Apply a small amount of a high quality lubricant such as Mopar® Lock Cylinder Lubricant directly into the lock cylinder.

Windshield Wiper Blades

The rubber edges of the wiper blades and the windshield should be cleaned periodically with a sponge or soft cloth and a mild nonabrasive cleaner to remove accumulations of salt or road film.

Operation of the wipers on dry glass for long periods may cause deterioration of the wiper blades. Always use washer fluid when using the wipers to remove salt or dirt from a dry windshield.

Avoid using the wiper blades to wipe frost or ice from the windshield. Keep the blade rubber out of contact with petroleum products such as engine oil, gasoline, etc.

Windshield Washers — Front and Rear

On vehicles equipped with a Vehicle Information Center, the low washer fluid level will be indicated. When the sensor detects a low fluid level, the windshield will light on the vehicle graphic outline and the “Washer Fluid Low” message will be displayed.

The fluid reservoir for the windshield washers and the rear window washer is shared. It is located in the front of the engine compartment on the passenger side and should be checked for fluid level at regular intervals. Fill

the reservoir with windshield washer solvent (not antifreeze/coolant) and operate the system for a few seconds to flush out the residual water.

WARNING!

Commercially available windshield washer solvents are flammable. They could ignite and burn you. Care must be exercised when filling or working around the washer solution.

Exhaust System

The best protection against carbon monoxide entry into the vehicle body is a properly maintained engine exhaust system.

If you notice a change in the sound of the exhaust system; or if the exhaust fumes can be detected inside the vehicle; or when the underside or rear of the vehicle is damaged;

have an authorized technician inspect the complete exhaust system and adjacent body areas for broken, damaged, deteriorated, or mispositioned parts. Open seams or loose connections could permit exhaust fumes to seep into the passenger compartment. In addition, inspect the exhaust system each time the vehicle is raised for lubrication or oil change. Replace as required.

Cooling System

WARNING!

You or others can be badly burned by hot antifreeze/coolant or steam from your radiator. If you see or hear steam coming from under the hood, don't open the hood until the radiator has had time to cool. Never try to open a cooling system pressure cap when the radiator or coolant bottle is hot.

Engine Coolant Checks

Check antifreeze/coolant protection every 12 months (before the onset of freezing weather, where applicable). If antifreeze/coolant is dirty or rusty in appearance, the system should be drained, flushed and refilled with fresh antifreeze/coolant. Check the front of the A/C condenser for any accumulation of bugs, leaves, etc. If dirty, clean by gently spraying water from a garden hose vertically down the face of the condenser.

Check the engine cooling system hoses for brittle rubber, cracking, tears, cuts, and tightness of the connection at the coolant recovery bottle and radiator. Inspect the entire system for leaks.

With the engine at normal operating temperature (but not running), check the cooling system pressure cap for proper vacuum sealing by draining a small amount of coolant from the radiator drain cock. If the cap is sealing properly, the antifreeze/coolant will begin to drain from

the coolant recovery bottle. DO NOT REMOVE THE COOLANT PRESSURE CAP WHEN THE COOLING SYSTEM IS HOT.

Cooling System — Drain, Flush, And Refill

At the intervals shown in the appropriate "Maintenance Schedule," the system should be drained, flushed, and refilled.

If the solution is dirty and contains a considerable amount of sediment, clean and flush with reliable cooling system cleaner. Follow with a thorough rinsing to remove all deposits and chemicals. Properly dispose of old antifreeze/coolant solution.

Selection Of Engine Coolant

Use only the manufacturer's recommended antifreeze/coolant, refer to Recommended Fluids, Lubricants, and Genuine Parts for correct antifreeze/coolant type.

CAUTION!

Mixing of antifreeze/coolant other than the specified HOAT antifreeze/coolant may result in decreased corrosion protection and engine damage. If a non-HOAT antifreeze/coolant is introduced into the cooling system in an emergency, it should be replaced with the specified antifreeze/coolant as soon as possible.

Do not use plain water alone or alcohol base antifreeze/coolant products. Do not use additional rust inhibitors or antirust products, as they may not be compatible with the antifreeze/coolant and may plug the radiator.

This vehicle has not been designed for use with Propylene Glycol based antifreeze/coolant. Use of Propylene Glycol base antifreeze/coolant is not recommended.

Adding Engine Coolant

Your vehicle has been built with an improved antifreeze/coolant that allows extended maintenance intervals. This antifreeze/coolant can be used up to 5 Years or 100,000 miles before replacement. To prevent reducing this extended maintenance period, it is important that you use the same antifreeze/coolant throughout the life of your vehicle. Please review these recommendations for using Hybrid Organic Additive Technology (HOAT) antifreeze/coolant.

When adding antifreeze/coolant, a minimum solution of 50% recommended Mopar Antifreeze/ Coolant 5 Year/ 100,000 Mile Formula HOAT (Hybrid Organic Additive Technology), or equivalent, in water should be used. Use higher concentrations (not to exceed 70%) if temperatures below -34°F (-37°C) are anticipated.

Use only high purity water such as distilled or deionized water when mixing the water/antifreeze (coolant) solution. The use of lower quality water will reduce the amount of corrosion protection in the engine cooling system.

Please note that it is the owner's responsibility to maintain the proper level of protection against freezing according to the temperatures occurring in the area where the vehicle is operated.

NOTE: Mixing antifreeze/coolant types will decrease the life of the antifreeze/coolant and will require more frequent antifreeze/coolant changes.

Cooling System Pressure Cap

The cap must be fully tightened to prevent loss of antifreeze/coolant, and to insure that antifreeze/coolant will return to the radiator from the coolant recovery tank.

The cap should be inspected and cleaned if there is any accumulation of foreign material on the sealing surfaces.

WARNING!

The warning words **DO NOT OPEN HOT** on the cooling system pressure cap are a safety precaution. Never add antifreeze/coolant when the engine is overheated. Do not loosen or remove the cap to cool an overheated engine. Heat causes pressure to build up in the cooling system. To prevent scalding or injury, do not remove the pressure cap while the system is hot or under pressure.

Disposal of Used Engine Coolant

Used ethylene glycol-based antifreeze/coolant is a regulated substance requiring proper disposal. Check with your local authorities to determine the disposal rules for your community. To prevent ingestion by animals and

children, do not store ethylene glycol-based antifreeze/coolant in open containers or allow it to remain in puddles on the ground. If ingested by a child, contact a physician immediately. Clean up any ground spills immediately.

Engine Coolant Level

The coolant bottle provides a quick visual method for determining that the antifreeze/coolant level is adequate. With the engine idling, and warm to normal operating temperature, the level of the antifreeze/coolant in the bottle should be between the ranges indicated on the bottle.

The radiator normally remains completely full, so there is not need to remove the radiator cap unless checking for antifreeze/coolant freeze point or replacing antifreeze/coolant. Advise your service attendant of this. As long as the engine operating temperature is satisfactory, the coolant bottle need only be checked once a month.

When additional antifreeze/coolant is needed to maintain the proper level, it should be added to the coolant bottle. Do not overfill.

Points To Remember

NOTE: When the vehicle is stopped after a few miles (kilometers) of operation, you may observe vapor coming from the front of the engine compartment. This is normally a result of moisture from rain, snow, or high humidity accumulating on the radiator and being vaporized when the thermostat opens, allowing hot antifreeze/coolant to enter the radiator.

If an examination of your engine compartment shows no evidence of radiator or hose leaks, the vehicle may be safely driven. The vapor will soon dissipate.

- Do not overfill the coolant recovery bottle.
- Check antifreeze/coolant freeze point in the radiator and in the coolant recovery bottle. If antifreeze/coolant needs to be added, contents of coolant recovery bottle must also be protected against freezing.
- If frequent antifreeze/coolant additions are required, or if the level in the coolant recovery bottle does not drop when the engine cools, the cooling system should be pressure tested for leaks.
- Maintain antifreeze/coolant concentration at 50% HOAT antifreeze/coolant (minimum) and distilled water for proper corrosion protection of your engine which contains aluminum components.
- Make sure that the radiator and coolant recovery bottle hoses are not kinked or obstructed.
- Keep the front of the radiator clean. If your vehicle is equipped with air conditioning, keep the front of the condenser clean, also.
- Do not change the thermostat for summer or winter operation. If replacement is ever necessary, install

ONLY the correct type thermostat. Other designs may result in unsatisfactory cooling performance, poor gas mileage, and increased emissions.

Hoses and Vacuum/Vapor Harnesses

Inspect surfaces of hoses and nylon tubing for evidence of heat and mechanical damage. Hard or soft spots, brittle rubber, cracking, tears, cuts, abrasions, and excessive swelling indicate deterioration of the rubber.

Pay particular attention to the hoses nearest to high heat sources such as the exhaust manifold. Inspect hose routing to be sure hoses do not touch any heat source or moving component that may cause heat damage or mechanical wear.

Insure nylon tubing in these areas has not melted or collapsed. Inspect all hose connections such as clamps and couplings to make sure they are secure and no leaks

are present. Components should be replaced immediately if there is any evidence of degradation that could cause failure.

Brake System

In order to assure brake system performance, all brake system components should be inspected periodically. Refer to the appropriate "Maintenance Schedule" in Section 8 for suggested service intervals.

WARNING!

Riding the brakes can lead to brake failure and possibly an accident. Driving with your foot resting or riding on the brake pedal can result in abnormally high brake temperatures, excessive lining wear, and possible brake damage. You wouldn't have your full braking capacity in an emergency.

Brake and Power Steering System Hoses

When servicing the vehicle for scheduled maintenance, inspect surface of hoses for evidence of heat and mechanical damage. Hard and brittle rubber, cracking, tears, cuts, abrasion, and excessive swelling suggest deterioration of the rubber. Particular attention should be made to examining those hose surfaces nearest to high heat sources, such as the exhaust manifold.

Inspect all hose clamps and couplings to make sure they are secure and no leaks are present.

NOTE: Often fluids such as oil, power steering fluid, and brake fluid are used during assembly plant operations to ease the assembly of hoses to couplings. Therefore, oil wetness at the hose-coupling area is not necessarily an indication of leakage. Actual dripping of hot fluid when systems are under pressure (during vehicle operation) should be noted before hose is replaced based on leakage.

NOTE: Inspection of brake hoses should be done whenever the brake system is serviced and every engine oil change.

WARNING!

Worn brake hoses can burst and cause brake failure. You could have an accident. If you see any signs of cracking, scuffing, or worn spots, have the brake hoses replaced immediately.

Brake Master Cylinder

The fluid level in the master cylinder should be checked when performing under hood services, or immediately if the brake system warning lamp shows system failure

Be sure to clean the top of the master cylinder area before removing the cap. If necessary, add fluid to bring the fluid level up to the requirements described on the brake

fluid reservoir. With disc brakes, fluid level can be expected to fall as the brake pads wear. However, low fluid level may be caused by a leak and a checkup may be needed.

Use only manufacturer's recommended brake fluid, refer to Recommended Fluids, Lubricants, and Genuine Parts for correct fluid type.

WARNING!

Use of a brake fluid that may have a lower initial boiling point or unidentified as to specification, may result in sudden brake failure during hard prolonged braking. You could have an accident.

WARNING!

Overfilling the brake fluid reservoir can result in spilling brake fluid on hot engine parts and the brake fluid catching fire.

Use only brake fluid that has been in a tightly closed container to avoid contamination from foreign matter. Do not allow petroleum base fluid to contaminate the brake fluid as seal damage will result.

Automatic Transmission**Selection of Lubricant**

It is important that the proper lubricant is used in the transmission to assure optimum transmission performance. Use only manufacturer's recommended transmission fluid, refer to Recommended Fluids, Lubricants, and

Genuine Parts for correct fluid type. It is important that the transmission fluid be maintained at the prescribed level using the recommended fluid.

CAUTION!

Using a transmission fluid other than the manufacturer's recommended fluid may cause deterioration in transmission shift quality and/or torque converter shudder. Using a transmission fluid other than the manufacturer's recommended fluid will result in more frequent fluid and filter changes. Refer to Recommended Fluids, Lubricants, and Genuine Parts for correct fluid type.

Fluid Level Check

NOTE: If equipped with a dipstick, use the following procedure. If your vehicle has a capped dipstick tube, it

is sealed and should not be tampered with. Your authorized dealer has the proper tools to ensure that the fluid level is set properly.

Check the fluid level while the transmission is at normal operating temperature. This occurs after at least 15 miles (25 km) of driving. At normal operating temperature the fluid cannot be held comfortably between the fingertips.

To check the automatic transmission fluid level properly, the following procedure must be used:

1. Operate the engine at idle speed and normal operating temperature.
2. The vehicle must be on level ground.
3. Fully apply the parking brake and press the brake pedal.
4. Place the gear selector momentarily in each gear position ending with the lever in P (Park).

5. Remove the dipstick, wipe it clean and reinsert it until seated.

6. Remove the dipstick again and note the fluid level on both sides. The fluid level should be between the "HOT" (upper) reference holes on the dipstick at normal operating temperature. The fluid level is only valid if there is a solid coating of oil is seen on both sides of the dipstick. If the fluid is low, add as required into the dipstick tube. **Do not overfill.** After adding any quantity of oil through the oil fill tube, wait a minimum of two (2) minutes for the oil to fully drain into the transmission before rechecking the fluid level.

NOTE: If it is necessary to check the transmission **below** the operating temperature, the fluid level should be between the two "COLD" (lower) holes on the dipstick with the fluid at approximately 70°F (21°C) (room temperature). If the fluid level is correctly established at room temperature, it should be between the "HOT"

(upper) reference holes when the transmission reaches 180°F (82°C). Remember it is best to check the level at the normal operating temperature.

CAUTION!

Be aware that if the fluid temperature is below 50°F (10°C) it may not register on the dipstick. Do not add fluid until the temperature is elevated enough to produce an accurate reading.

7. Check for leaks. Release parking brake.

To prevent dirt and water from entering the transmission after checking or replenishing fluid, make certain that the dipstick cap is properly reseated. It is normal for the dipstick cap to spring back slightly from its fully seated position, as long as its seal remains engaged in the dipstick tube.

Special Additives

The manufacturer recommends against the addition of any additives to the transmission. Exception to this policy is the use of special dyes to aid in detecting fluid leaks.

Transfer Case**Fluid Level Check**

Inspect the transfer case for fluid leaks. If a fluid leak is found, the transfer case fluid level can be checked by removing the filler plug located on the back side of the transfer case. The fluid level should be at the bottom edge of the filler plug hole when the vehicle is in a level position.

Adding Fluid

Add fluid at the filler hole until it runs out of the hole when the vehicle is in a level position.

Drain

First remove fill plug, then remove drain plug. Recommended tightening torque for drain and fill plugs is 15–25 ft. lbs (20–34 N·m).

CAUTION!

When installing plugs, do not overtighten. You could damage them and cause them to leak.

Selection of Lubricant

Use only manufacturer's recommended fluid, refer to Recommended Fluids, Lubricants, and Genuine Parts for correct fluid type.

Front/Rear Axle Fluid

Front Axle Fluid Level Check

Lubricant should be to the bottom of the oil fill hole.

Rear Axle Fluid Level Check

Lubricant should be 1/2" (1 cm) below the oil fill hole.

Adding Fluid

Add lubricant only at the fill hole and only to the level specified above.

Selection of Lubricant

Use only manufacturer's recommended fluid, refer to Recommended Fluids, Lubricants, and Genuine Parts for correct fluid type.

Appearance Care And Protection From Corrosion

Protection of Body and Paint from Corrosion

Vehicle body care requirements vary according to geographic locations and usage. Chemicals that make roads passable in snow and ice, and those that are sprayed on trees and road surfaces during other seasons, are highly corrosive to the metal in your vehicle.

The following maintenance recommendations will enable you to obtain maximum benefit from the corrosion resistance built into your vehicle.

What Causes Corrosion?

Corrosion is the result of deterioration or removal of paint and protective coatings from your vehicle.

The most common causes are:

- Road salt, dirt and moisture accumulation.
- Stone and gravel impact.

- Insects, tree sap and tar.
- Salt in the air near seacoast localities.
- Atmospheric fallout/industrial pollutants.

Washing

- Wash your vehicle regularly. Always wash your vehicle in the shade using a mild car wash soap and rinse the panels completely with clear water.
- If insects, tar or other similar deposits have accumulated on your vehicle, wash it as soon as possible.
- Use Mopar® Auto Polish to remove road film and stains and to polish your vehicle. Take care never to scratch the paint.
- Avoid using abrasive compounds and power buffing that may diminish the gloss or thin out the paint finish.

CAUTION!

Do not use abrasive or strong cleaning materials such as steel wool or scouring powder, which will scratch metal and painted surfaces.

Special Care

- If you drive on salted or dusty roads or if you drive near the ocean, hose off the undercarriage at least once a month.
- The drain holes in the lower edges of the doors, rocker panels, and rear liftgate must be kept clear and open.
- If you detect any stone chips or scratches in the paint, touch them up immediately. The cost of such repairs is considered the responsibility of the owner.

- If your vehicle is damaged due to an accident or similar cause which destroys the paint and protective coating, have your vehicle repaired as soon as possible. The cost of such repairs is considered the responsibility of the owner.
- If you carry special cargo such as chemicals, fertilizers, de-icer salt, etc., assure that such materials are well packaged and sealed.
- If a lot of driving is done on gravel roads, consider mud or stone shields behind each wheel.
- Use Mopar® Touch-Up Paint on scratches as soon as possible. Your authorized dealer has touch-up paint to match the color of your vehicle.
- Aluminum wheels should be cleaned regularly with mild soap and water to prevent corrosion. To remove heavy soil, select a nonabrasive, non-acidic cleaner. Do

not use scouring pads or metal polishes. Avoid automatic car washes that use acidic solutions or harsh brushes that may damage the wheels' protective finish.

Interior Care

Use Mopar® Fabric Cleaner to clean fabric upholstery and carpeting.

Use Mopar® Vinyl Cleaner to clean vinyl upholstery.

Mopar® Vinyl Cleaner is specifically recommended for interior vinyl trim.

Do not use silicon based cleaning products on leather seats. They could cause cracking of the seat leather.

Leather Seat Care & Cleaning

Leather is best preserved by regular cleaning with a damp soft cloth. Small particles of dirt can act as an abrasive and damage the leather surface and should be removed promptly with a damp cloth. Stubborn soils can

be removed easily with a soft cloth and Mopar® Total Clean. Care should be taken to avoid soaking the leather with any liquid. Please do not use polishes, oils, cleaning fluids, solvents, detergents, or ammonia based cleaners to clean the leather. Application of a leather conditioner is not required to maintain the original condition.

Glass Surfaces

All glass surfaces should be cleaned on a regular basis with any commercial household-type glass cleaner. Never use an abrasive type cleaner. Use caution when cleaning inside rear windows equipped with electric defrosters. Do not use scrapers or other sharp instruments which may scratch the elements.

When cleaning the rear view mirror, spray cleaner on the towel or rag that you are using. Do not spray cleaner directly on the mirror.

WARNING!

Do not use volatile solvents for cleaning purposes. Many are potentially flammable, and if used in closed areas they may cause respiratory harm. Do not use gasoline, turpentine, kerosene, etc. for cleaning. Use the Mopar® recommended products or the equivalents.

Carpet

Vacuum your carpet regularly to prevent a soil build-up. Shampoo soiled carpet with a reliable upholstery cleaner, using a natural sponge or soft bristle brush. After carpet dries, vacuum it thoroughly.

Seat Belt Maintenance

Do not bleach, dye or clean the belts with chemical solvents or abrasive cleaners. This will weaken the fabric. Sun damage will also weaken the fabric.

If the belts need cleaning, use a mild soap solution or lukewarm water. Do not remove the belts from the vehicle to wash them.

Replace the belts if they appear frayed or worn or if the buckles do not work properly.

Maintenance After Off-Pavement Driving

After extended operation in mud, sand or water, or similar dirty conditions, have your brake discs, brake linings, and axle joints inspected and cleaned as soon as possible. This will prevent any abrasive material from causing excessive wear or unpredictable braking action.

Following off-pavement usage, completely inspect the underbody of your vehicle. Check tires, body structure, steering, suspension and exhaust system for damage. Check threaded fasteners for looseness, particularly on the chassis, drivetrain components, steering and suspension. Retighten, if required, to torque values specified in the Service Manual. Also check for accumulations of

vegetation or brush that could become a fire hazard, or conceal damage to fuel lines, brake hoses, axle pinion seals, and propeller shafts.

CAUTION!

Under frequent heavy-duty driving conditions, change all lubricants and lubricate body components, all driveline joints and steering linkage more often than in normal service to prevent excessive wear.

FUSE PANEL

Interior Fuses

The fuse panel is on the lower instrument panel just to the left of the steering column.

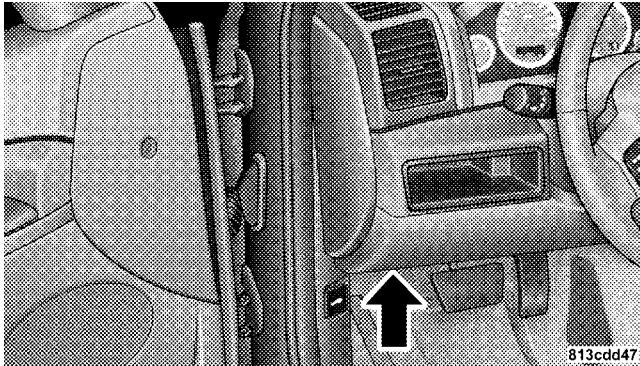

Fuse Panel Location

Cavity	Fuse/Color	Description
1	30 Amp Pink	Audio Amp (B+)
2	15 Amp Blue	Sunroof (B+)
3	10 Amp Red	Htd Mirror (EBL)
4	20 Amp Yellow	Rr Pwr Out (B+)
5	10 Amp Red	Rr HVAC (R/O)
6	10 Amp Red	OCM (B+)
7	20 Amp Yellow	Door Locks (B+)
8	15 Amp Blue	Steer Col Lock (B+)
9	20 Amp Yellow	Pwr Outlet (B+)
10	10 Amp Red	Ign Run Only Out (R/O)
11	Spare	
12	10 Amp Red	Mem. Sw, Courtesy Lamp (B+)
13	Spare	
14	20 Amp Yellow	Cigar Ltr (R/A)
15	10 Amp Red	Tire Press Mon (R/O)

Cavity	Fuse/Color	Description
16	10 Amp Red	SCM, Cluster OBD (B+)
17	15 Amp Blue	Flipper Glass (B+)
19	10 Amp Red	OCM (R/S)
20	10 Amp Red	WCM, Cluster (R/S)
21	15 Amp Blue	Autowipe (Accy Delay)
22	15 Amp Blue	Rear Wiper (B+)
24	10 Amp Red	PDC, FCM, A580 (R/S)
25	10 Amp Red	ABS, Trans. Case Switch (R/S)
CB1	20 Amp	Cycle -Wipers (B+)
CB2	20 Amp	Non - Cycle Seats (B+)
CB3	20 Amp	Non - Cycle Windows (De- lay)

Underhood Fuses (Power Distribution Center)

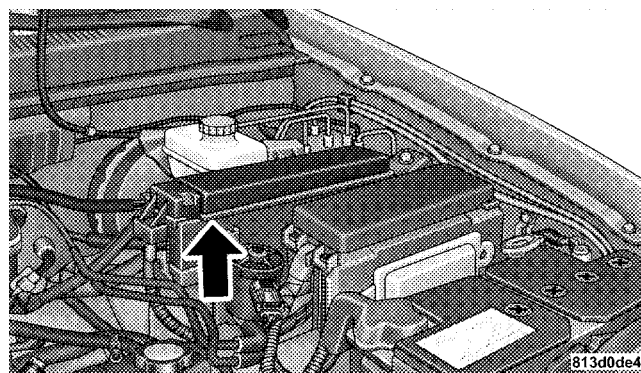

Power Distribution Center

Cavity	Fuse/Color	Description
1	40 Amp Green	HVAC Blower
2	30 Amp Pink	Power Outlets
3	30 Amp Pink	Rr Wiper/Ign R/O
4	30 Amp Pink	ABS Pump
5	50 Amp Red	Cabin Htr 1 (Diesel Only)
6	50 Amp Red	ASD
7	30 Amp Pink	Rr HVAC (XK)
8	40 Amp Green	Acc Delay/Seats
9	Spare	
10	40 Amp Green	Starter/JB Power
11	30 Amp Pink	Cig Ltr/T-Tow
12	40 Amp Green	EBL/Htd Mirror
13	40 Amp Green	JB Power
14	50 Amp Red	Cabin Htr 2 (Diesel Only)
15	50 Amp Red	Cabin Htr 3 (Diesel Only)
16	25 Amp Natural	IPM/Coils

Cavity	Fuse/Color	Description
17	Spare	
18	20 Amp Yellow	TCM/AC Clutch
19	20 Amp Yellow	Ign Sw
20	20 Amp Yellow	PCM Batt (Gasoline Only)
21	30 Amp Pink	ABS Valves
22	Spare	
23	20 Amp Yellow	FDCM
24	20 Amp Yellow	Fuel Pump
25	20 Amp Yellow	FDCM/E-Diff.
26	15 Amp Blue	Hyd/PCM (Diesel Only)
27	15 Amp Blue	Brake/Stop Lamps
28	25 Amp Natural	NGC/Injectors
29	Spare	
30	Spare	
31	Mini Relay	Cabin Htr 1 Rly (Diesel Only)

Cavity	Fuse/Color	Description
32	Micro Relay	TCM Rly (Gasoline Only)
33	Micro Relay	Starter Rly
34	Micro Relay	AC Clutch Rly
35	Micro Relay	Fuel Pump Rly
36	Mini Relay	Cabin Htr 3 Rly (Diesel Only)
38	Mini Relay	Cabin Htr 2 Rly (Diesel Only)
39	Mini Relay	HVAC Blower Rly
40	Mini Relay	ASD Rly

Underhood Fuses (Integrated Power Module)

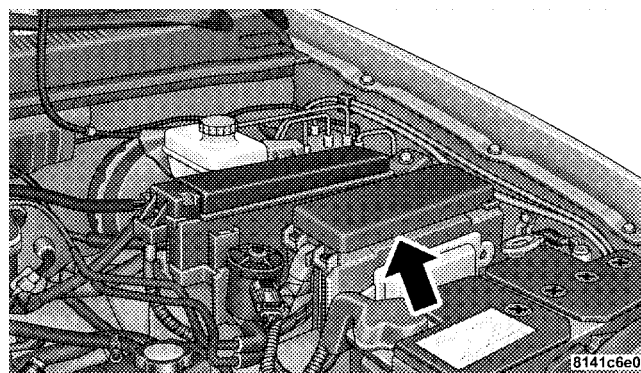

Integrated Power Module

Cavity	Fuse/Color	Description
1	Micro Relay	Wiper On/Off Rly
2	Micro Relay	Wiper Hi/Lo Rly
3	Micro Relay	Horn Rly
4	Micro Relay	Rear Fog Rly (BUX Only)
5	Micro Relay	Lt T-Tow Stop/Turn Rly
6	Micro Relay	Rt T-Tow Stop/Turn Rly
7	Micro Relay	Park Lamps Rly
8	10 Amp Red	Lt Park Lamps
9	10 Amp Red	T-Tow Park Lamps
10	10 Amp Red	Rt Park Lamps
11	Mini Relay	Rad Fan Hi Rly
12	20 Amp Yellow	FCM Batt #4
13	20 Amp Yellow	FCM Batt #2
14	20 Amp Yellow	Adjustable Pedal
15	20 Amp Yellow	Ft Fog Lamps
16	20 Amp Yellow	Horn

Cavity	Fuse/Color	Description
17	20 Amp Yellow	Rear Fogs
18	20 Amp Yellow	FCM Batt #1
19	20 Amp Yellow	Lt T-Tow Stop/Turn
20	20 Amp Yellow	FCM Batt #3
21	20 Amp Yellow	Rt T-Tow Stop/Turn
22	30 Amp Pink	FDCM Mod
23	50 Amp Red	Rad Fan
24	Mini Relay	Rad Fan Lo Rly
25	Micro Relay	Ft Fog Lamps Rly
26	Micro Relay	Adjustable Pedal Rly
27	15 Amp Blue	IOD #1
28	20 Amp Yellow	IOD #2 (Audio)
29	10 Amp Red	ORC (Ign R/.S)
30	10 Amp Red	ORC (Ign R/O)

VEHICLE STORAGE

If you are leaving your vehicle dormant for more than 21 days you may want to take steps to protect your battery. You may:

- Remove fuse #27 in the Intelligent Power Module labeled Ignition-Off Draw (IOD#1).
- Or, disconnect the negative cable from the battery.
- Anytime you store your vehicle, or keep it out of service (i.e. vacation) for two weeks or more, run the air conditioning system at idle for about five minutes in the fresh air and high blower setting. This will insure adequate system lubrication to minimize the possibility of compressor damage when the system is started again.

REPLACEMENT BULBS

Interior Lights	Bulb Type
Glove Box Light	194
Grab Handle Light	L002825W5W
Overhead Console Reading Lights	VT4976
Rear Cargo Light	214-2
Visor Vanity Light	V26377
Underpanel Courtesy Lights	906
Instrument Cluster (General Illumination)	103
Telltale/Hazard Light	74

* Available only from authorized dealers.

Exterior Lights	Bulb Type
Backup Lights	3157A
Fog Lights	9145
Front Park Lights (Limited)	194NA
Front Park Lights (Laredo)	194NA
Front Park/Turn Light (Limited)	3157A

Exterior Lights	Bulb Type
Front Park/Turn Light (Laredo)	3157A
Front Side Marker (Limited)	194NA
Front Side Marker (Laredo)	194NA
Headlights (Low Beam)	9006
Headlights (High Beam)	9005
Rear License Plate Light	168
Rear Stop/Tail Lights	3157A
Rear Turn Signal Lights (2)	3157A

NOTE: Numbers refer to commercial bulb types that can be purchased from your authorized dealer.

If a bulb needs to be replaced, visit your authorized dealer or refer to the applicable Service Manual.

BULB REPLACEMENT

Head Light

1. Open the hood.
2. Remove the headlamp cover.



3. Turn the low or high beam bulb 1/4 turn counter clockwise to remove from housing.

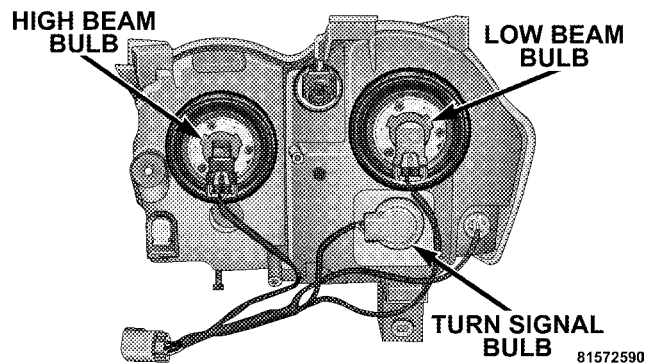

4. Disconnect the electrical connector and replace the bulb.

CAUTION!

Do not touch the new bulb with your fingers. Oil contamination will severely shorten bulb life. If the bulb comes in contact with any oily surface, clean the bulb with rubbing alcohol.

Front Turn Signal

1. Open the hood.
2. Remove the headlamp cover.



3. Turn the turn signal bulb 1/4 turn counter clockwise to remove from housing.

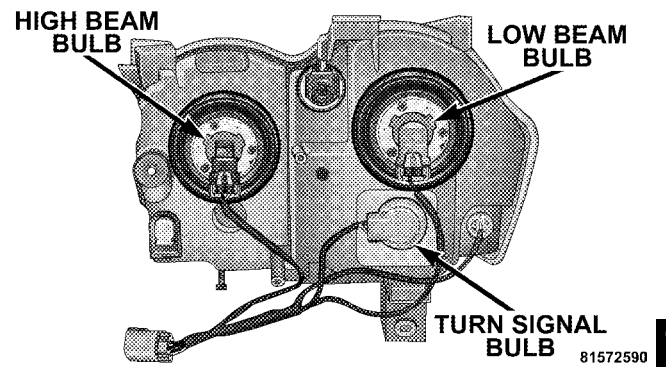

4. Disconnect the electrical connector and replace the bulb.

CAUTION!

Do not touch the new bulb with your fingers. Oil contamination will severely shorten bulb life. If the bulb comes in contact with any oily surface, clean the bulb with rubbing alcohol.

CAUTION!

Do not touch the new bulb with your fingers. Oil contamination will severely shorten bulb life. If the bulb comes in contact with any oily surface, clean the bulb with rubbing alcohol.

Front Fog Light

1. Reach behind the front fascia from under the vehicle.
2. Turn the front fog light bulb 1/4 turn counter clockwise to remove from housing.
3. Disconnect the electrical connector and replace bulb.

Rear Tail, Stop, Turn Signal, and Back-Up Lights

1. Raise the liftgate.
2. Remove the two Torx fasteners.

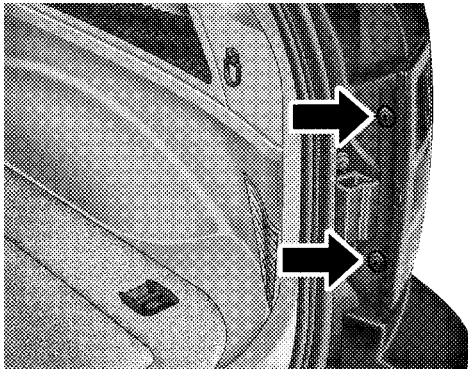

81572594

3. Squeeze the socket assembly tabs to remove it from the housing.

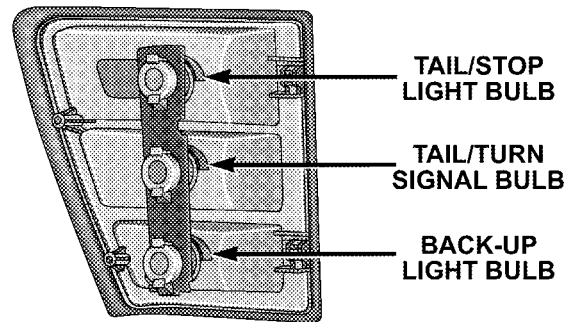

815727c5

4. Pull the bulb to remove it from the socket.
5. Replace the bulb, reinstall the socket, and reattach the light assembly.

Center High Mounted Stop Light (CHMSL)

1. Remove the two screws securing the CHMSL.

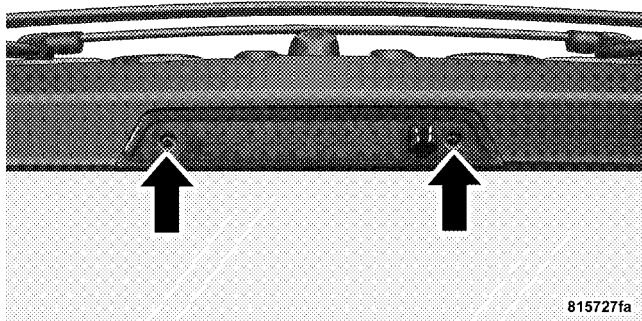

2. Twist the bulb socket to remove from the CHMSL housing.

3. Pull the bulb out of the socket.

4. Replace the bulb, reinstall the socket and reattach the CHMSL.

FLUID CAPACITIES

	U.S.	Metric
Fuel (Approximate)	20.6 Gallons	78 Liters
Engine Oil with Filter		
3.7 Liter Engine (5W-30, API Certified)	5 Qts	4.7 Liters
4.7 Liter Engine (5W-30, API Certified)	6 Qts	5.7 Liters
5.7 Liter Engine (5W-20, API Certified)	7 Qts	6.6 Liters
Cooling System *		
3.7 Liter Engine (Mopar® Engine Coolant/Antifreeze 5 Year/ 100,000 Mile Formula)	9 Qts	10 Liters
4.7 Liter Engine (Mopar® Engine Coolant/Antifreeze 5 Year/ 100,000 Mile Formula)	14.5 Qts	13.7 Liters
5.7 Liter Engine (Mopar® Engine Coolant/Antifreeze 5 Year/ 100,000 Mile Formula)	14.5 Qts	13.7 Liters

* Includes heater and coolant recovery bottle filled to MAX level.

RECOMMENDED FLUIDS, LUBRICANTS AND GENUINE PARTS**Engine**

Component	Fluid, Lubricant, or Genuine Part
Engine Coolant	Mopar® Antifreeze/Coolant 5 Year/100,000 Mile Formula HOAT (Hybrid Organic Additive Technology)
Engine Oil (3.7L/4.7L Engines)	Use API Certified SAE 5W-30 Engine Oil, meeting the requirements of DaimlerChrysler Material Standard MS-6395.
Engine Oil (5.7L Engines)	Use API Certified SAE 5W-20 Engine Oil, meeting the requirements of DaimlerChrysler Material Standard MS-6395.
Oil Filter (All Engines)	Mopar® Oil Filter (P/N 05281090)
Spark Plugs	Refer to the Vehicle Emission Control Information label in the engine compartment.
Fuel Selection (3.7L and 4.7L Engines)	87 Octane
Fuel Selection (5.7L Engines)	87 Octane Acceptable - 89 Octane Recommended

Chassis

Component	Fluid, Lubricant, or Genuine Part
Automatic Transmission	Mopar® ATF+4 Automatic Transmission Fluid
Transfer Case	Mopar® ATF+4 Automatic Transmission Fluid
Axle Differential (Front-Rear)	Mopar® Synthetic Gear & Axle Lubricant SAE 75W-140 (API-GL5) or equivalent with friction modifier additive.
Brake Master Cylinder	Mopar® DOT 3 Brake Fluid, SAE J1703 should be used. If DOT 3, SAE J1703 brake fluid is not available, then DOT 4 is acceptable. Use only recommended brake fluids.
Power Steering Reservoir	This system requires the use of Mopar® Hydraulic System Power Steering Fluid (P/N 05142893AA) or equivalent, which meets DaimlerChrysler Material Standard MS-10838.

MAINTENANCE SCHEDULES

CONTENTS

■ Emission Control System Maintenance	362	□ Schedule "B"	365
■ Maintenance Schedules	362	□ Schedule "A"	376

EMISSION CONTROL SYSTEM MAINTENANCE

The “Scheduled” maintenance services, listed in **bold type** must be done at the times or mileages specified to assure the continued proper functioning of the emission control system. These, and all other maintenance services included in this manual, should be done to provide best vehicle performance and reliability. More frequent maintenance may be needed for vehicles in severe operating conditions such as dusty areas and very short trip driving.

Inspection and service also should be done any time a malfunction is suspected.

NOTE: Maintenance, replacement, or repair of the emission control devices and systems on your vehicle may be performed by any automotive repair establishment or individual using any automotive part which has been certified pursuant to U.S. EPA or, in the State of California, California Air Resources Board regulations.

MAINTENANCE SCHEDULES

There are two maintenance schedules that show the **required** service for your vehicle.

First is Schedule “**B**”. It is for vehicles that are operated under the conditions that are listed below and at the beginning of the schedule.

- Day or night temperatures are below 32°F (0°C)
- Stop and go driving
- Excessive engine idling
- Driving in dusty conditions
- Short trips of less than 10 miles (16.2 km)
- More than 50% of your driving is at sustained high speeds during hot weather, above 90°F (32°C)
- Trailer towing
- Taxi, police, or delivery service (commercial service)

- Off-road or desert driving
- **If equipped for and operated with E-85 (ethanol) fuel.**

NOTE: Most vehicles are operated under the conditions listed for Schedule "B."

NOTE: If ANY of these apply to you, change your engine oil every 3,000 miles (5 000 km) or 3 months, whichever comes first, and follow the maintenance recommendations in "Maintenance Schedule B."

NOTE: If ANY of these apply to you then flush and replace your engine coolant every 102,000 miles (163 000 km) or 60 months, whichever comes first, and follow "Schedule B" of the "Maintenance Schedules" section of this manual.

Second is Schedule "A". It is for vehicles that are not operated under any of the conditions listed under Schedule "B."

Use the schedule that best describes your driving conditions. Where time and mileage are listed, follow the interval that occurs first.

CAUTION!

Failure to perform the required maintenance items may result in damage to the vehicle.

At Each Stop for Fuel

- Check the engine oil level about 5 minutes after a fully warmed engine is shut off. Checking the oil level while the vehicle is on level ground will improve the accuracy of the oil level reading. Add oil only when the level is at or below the ADD or MIN mark.
- Check the windshield washer solvent, add as required.

364 MAINTENANCE SCHEDULES

Once a Month

- Check the tire pressure and look for unusual wear or damage.
- Inspect the battery and clean and tighten the terminals as required.
- Check the fluid levels of the coolant reservoir, brake master cylinder, and transmission, and add as needed.
- Check all lights and all other electrical items for correct operation.

At Each Oil Change

- Change the engine oil filter.
- Inspect the exhaust system.
- Inspect brake hoses.
- Check the engine coolant/anti-freeze level, hoses, and clamps.
- After completion of off-road operation, the underside of the vehicle should be thoroughly inspected. Examine threaded fasteners for looseness.

Schedule "B"

Follow this schedule if you usually operate your vehicle under one or more of the following conditions.

- Day or night temperatures are below 32°F (0°C)
- Stop and go driving
- Excessive engine idling
- Driving in dusty conditions
- Short trips of less than 10 miles (16.2 km)
- More than 50% of your driving is at sustained high speeds during hot weather, above 90°F (32°C)
- Trailer towing
- Taxi, police, or delivery service (commercial service)

- Off-road or desert driving
- **If equipped for and operated with E-85 (ethanol) fuel.**

NOTE: If ANY of these apply to you, change your engine oil every 3,000 miles (5 000 km) or 3 months, whichever comes first, and follow the maintenance recommendations in "Maintenance Schedule B."

NOTE: If ANY of these apply to you then flush and replace your engine coolant every 102,000 miles (163 000 km) or 60 months, whichever comes first, and follow "Schedule B" of the "Maintenance Schedules" section of this manual.

366 SCHEDULE "B"

Miles (Kilometers)	3,000 (5 000)	6,000 (10 000)	9,000 (14 000)	12,000 (19 000)	15,000 (24 000)
Change the engine oil and engine oil filter, if not replaced at 3 months.	X	X	X	X	X
Rotate the tires.		X		X	
Inspect the engine air cleaner filter, replace if necessary.					X
Lubricate the upper knuckle ball stud at steering & suspension ball joints.		X		X	
Drain and refill the front and rear axles.				X	
Inspect the brake linings.				X	

Miles (Kilometers)	18,000 (29 000)	21,000 (34 000)	24,000 (38 000)	27,000 (43 000)	30,000 (48 000)
Change the engine oil and engine oil filter, if not replaced at 3 months.	X	X	X	X	X
Rotate the tires.	X		X		X
Inspect the engine air cleaner filter, replace if necessary.					X
Inspect the PCV Valve, replace if necessary. ◇					X
Replace the spark plugs.					X
Lubricate the upper knuckle ball stud at steering & suspension ball joints.	X		X		X
Drain and refill the front and rear axles.			X		
Inspect the brake linings.			X		
Drain the transfer case and refill.					X

368 SCHEDULE "B"

Miles (Kilometers)	33,000 (53 000)	36,000 (58 000)	39,000 (62 000)	42,000 (67 000)	45,000 (72 000)
Change the engine oil and engine oil filter, if not replaced at 3 months.	X	X	X	X	X
Rotate the tires.		X		X	
Inspect the engine air cleaner filter, replace if necessary.					X
Drain and refill the front and rear axles.		X			
Inspect the brake linings.		X			
Lubricate the upper knuckle ball stud at steering & suspension ball joints.		X		X	

Miles (Kilometers)	48,000 (77 000)	51,000 (82 000)	54,000 (86 000)	57,000 (91 000)	60,000 (96 000)
Change the engine oil and engine oil filter, if not replaced at 3 months.	X	X	X	X	X
Rotate the tires.	X		X		X
Inspect the engine air cleaner filter, replace if necessary.					X
Inspect the PCV Valve, replace if necessary. ◇					X
Replace the spark plugs.					X
Inspect the ignition cables, replace if necessary (5.7L Only).					X
Inspect drive belt, replace if necessary.					X
Lubricate the upper knuckle ball stud at steering & suspension ball joints.	X		X		X
Inspect the brake linings.	X				X

370 SCHEDULE "B"

Miles (Kilometers)	48,000 (77 000)	51,000 (82 000)	54,000 (86 000)	57,000 (91 000)	60,000 (96 000)
Drain and refill the front and rear axles.	X				X
Drain and refill the automatic transmission fluid, and replace main sump filter (4.7L/5.7L Only).‡					X
Drain and refill the transfer case fluid.					X
Flush and replace engine coolant/anti-freeze at 60 months, if not done at 102,000 miles (163 000 km).					X

NOTE: ‡ Applies only if vehicle is used for frequent trailer towing, or fleet/commercial service.

Miles (Kilometers)	63,000 (101 000)	66,000 (106 000)	69,000 (110 000)	72,000 (115 000)	75,000 (120 000)
Change the engine oil and engine oil filter, if not replaced at 3 months.	X	X	X	X	X
Rotate the tires.		X		X	
Inspect the engine air cleaner filter, replace if necessary.					X
Inspect the drive belt, replace if necessary.					X
Lubricate the upper knuckle ball stud at steering & suspension ball joints.		X		X	
Inspect the brake linings.				X	
Drain and refill the front and rear axle fluid.				X	

372 SCHEDULE "B"

Miles (Kilometers)	78,000 (125 000)	81,000 (130 000)	84,000 (134 000)	87,000 (139 000)	90,000 (144 000)
Change the engine oil and engine oil filter, if not replaced at 3 months.	X	X	X	X	X
Rotate the tires.	X		X		X
Inspect the engine air cleaner filter, replace if necessary.					X
Inspect the PCV Valve, replace if necessary. ◇					X
Replace the spark plugs.					X
Inspect the drive belt, replace if necessary.					X
Lubricate the upper knuckle ball stud at steering & suspension ball joints.	X		X		X
Drain and refill the transfer case fluid.					X
Inspect the brake linings.			X		
Drain and refill the front and rear axle fluid.			X		

Miles (Kilometers)	93,000 (149 000)	96,000 (154 000)	99,000 (158 000)	102,000 (163 000)	105,000 (168 000)
Change the engine oil and engine oil filter, if not replaced at 3 months.	X	X	X	X	X
Rotate the tires.		X		X	
Inspect the engine air cleaner filter, replace if necessary.					X
Inspect the drive belt, replace if necessary.					X
Lubricate the upper knuckle ball stud at steering & suspension ball joints.		X		X	
Inspect the brake linings.		X			
Drain and refill the front and rear axle fluid.		X			
Flush and replace the engine coolant/anti-freeze, if not done at 60 months.				X	

374 SCHEDULE "B"

Miles (Kilometers)	108,000 (173 000)	111,000 (178 000)	114,000 (182 000)	117,000 (187 000)	120,000 (192 000)
Change the engine oil and engine oil filter, if not replaced at 3 months.	X	X	X	X	X
Rotate the tires.	X		X		X
Inspect the engine air cleaner filter, replace if necessary.					X
Inspect the PCV Valve, replace if necessary. ◇					X
Replace the spark plugs.					X
Inspect the ignition cables, replace if necessary (5.7L Only).					X
Inspect the drive belt, replace if necessary.					X
Lubricate the upper knuckle ball stud at steering & suspension ball joints.	X		X		X
Inspect the brake linings.	X				X
Drain and refill the front and rear axle fluid.	X				X

Miles (Kilometers)	108,000 (173 000)	111,000 (178 000)	114,000 (182 000)	117,000 (187 000)	120,000 (192 000)
Drain and refill the automatic transmission fluid, replace main sump filter, and spin-on cooler return filter (if equipped). (4.7L/5.7L Only).‡					X
Drain and refill the transfer case fluid.					X
Flush and replace the engine coolant/anti-freeze at 120 months, if not replaced at 102,000 miles (163 000 km).					X

NOTE: ‡ Applies only if vehicle is used for frequent trailer towing, or fleet/commercial service.

Inspection and service should also be performed anytime a malfunction is observed or suspected. Retain all receipts.

◇ This maintenance is recommended by the manufacturer to the owner, but is not required to maintain emissions warranty.

376 SCHEDULE "A"

Schedule "A"

Miles (Kilometers) [Months]	6,000 (10 000) [6]	12,000 (19 000) [12]	18,000 (29 000) [18]	24,000 (38 000) [24]	30,000 (48 000) [30]
Change the engine oil and engine oil filter.	X	X	X	X	X
Rotate the tires.	X	X	X	X	X
Inspect the engine air cleaner filter, and replace if necessary.					X
Replace the spark plugs.					X
Lubricate the upper knuckle ball stud at steering & suspension ball joints.		X		X	
Inspect the brake linings.			X		
Drain the transfer case and refill.					X

Miles (Kilometers) [Months]	36,000 (58 000) [36]	42,000 (67 000) [42]	48,000 (77 000) [48]	54, 000 (86 000) [54]
Change the engine oil and engine oil filter.	X	X	X	X
Rotate the tires.	X	X	X	X
Inspect the brake linings.	X			X
Lubricate the upper knuckle ball stud at steering & suspension ball joints.	X		X	

378 SCHEDULE "A"

Miles (Kilometers) [Months]	60,000 (96 000) [60]	66,000 (106 000) [66]	72,000 (115 000) [72]	78,000 (125 000) [78]
Change the engine oil and engine oil filter.	X	X	X	X
Rotate the tires.	X	X	X	X
Inspect the engine air cleaner filter, and replace if necessary.	X			
Inspect the PCV Valve, replace if necessary. ◇	X			
Replace the spark plugs.	X			
Inspect the ignition cables, replace if necessary (5.7L Only).	X			
Inspect the drive belt, replace if necessary.	X			
Lubricate the upper knuckle ball stud at steering & suspension ball joints.	X		X	
Flush and replace the engine coolant/anti-freeze, at 60 months if not done at 102,000 miles (163 000 km).	X			
Inspect the brake linings.			X	
Drain the transfer case and refill.	X			

Miles (Kilometers) [Months]	84,000 (134 000) [84]	90,000 (144 000) [90]	96,000 (154 000) [96]	102, 000 (163 000) [102]
Change the engine oil and engine oil filter.	X	X	X	X
Rotate the tires.	X	X	X	X
Inspect the engine air cleaner filter, and replace if necessary.		X		
Inspect the PCV Valve, replace if necessary. ◇		X		
Replace the spark plugs.		X		
Inspect the drive belt, replace if necessary.		X		
Lubricate the upper knuckle ball stud at steering & suspension ball joints.	X		X	
Inspect the brake linings.		X		
Flush and replace the engine coolant/anti-freeze if not replaced at 60 months.				X
Drain the transfer case and refill.		X		

380 SCHEDULE "A"

Miles (Kilometers) [Months]	108,000 (173 000) [108]	114,000 (182 000) [114]	120,000 (192 000) [120]
Change the engine oil and engine oil filter.	X	X	X
Rotate the tires.	X	X	X
Inspect the engine air cleaner filter, and replace if necessary.			X
Inspect the PCV Valve, replace if necessary. ◇			X
Replace the spark plugs.			X
Inspect the ignition cables, replace if necessary (5.7L Only).			X
Inspect the drive belt, replace if necessary.			X
Lubricate the upper knuckle ball stud at steering & suspension ball joints.	X		X
Inspect the brake linings.	X		
Flush and replace the engine coolant/anti-freeze if not done at 102,000 miles (163 000 km).			X
Drain the transfer case and refill.			X

Inspection and service should also be performed anytime a malfunction is observed or suspected. Retain all receipts.

◇ This maintenance is recommended by the manufacturer to the owner, but is not required to maintain emissions warranty.

WARNING!

You can be badly injured working on or around a motor vehicle. Do only that service work for which you have the proper equipment. If you have any doubt about your ability to perform a service job, take your vehicle to a competent mechanic.

IF YOU NEED CONSUMER ASSISTANCE

CONTENTS

■ Suggestions For Obtaining Service For Your Vehicle	384	■ Warranty Information	386
□ Prepare For The Appointment	384	■ Mopar® Parts	388
□ Prepare A List	384	■ Reporting Safety Defects	388
□ Be Reasonable With Requests	384	□ In Canada	388
■ If You Need Assistance	384	■ Publication Order Forms	389

SUGGESTIONS FOR OBTAINING SERVICE FOR YOUR VEHICLE**Prepare For The Appointment**

If you're having warranty work done, be sure to have the right papers with you. Take your warranty folder. All work to be performed may not be covered by the warranty, discuss additional charges with the service manager. Keep a maintenance log of your vehicle's service history. This can often provide a clue to the current problem.

Prepare A List

Make a written list of your vehicle's problems or the specific work you want done. If you've had an accident, or work done that is not on your maintenance log, let the service advisor know.

Be Reasonable With Requests

If you list a number of items, and you must have your vehicle by the end of the day, discuss the situation with the service advisor and list the items in order of priority. At many dealers you may obtain a rental vehicle at a minimal daily charge. If you need a rental, it is advisable to make these arrangements when you call for an appointment.

IF YOU NEED ASSISTANCE

The manufacturer and its dealers are vitally interested in your satisfaction. We want you to be happy with our products and services.

Warranty service must be done by an authorized Chrysler, Dodge, or Jeep dealer. We strongly recommend that you take your vehicle to your selling dealer. They know you and your vehicle best, and are most concerned that you get prompt and high quality service. The manufacturer's dealers have the facilities, factory-trained technicians, special tools, and the latest information to assure your vehicle is fixed correctly and in a timely manner.

This is why you should always talk to your dealer's service manager first. Most matters can be resolved with this process.

- If for some reason you are still not satisfied, talk to the general manager or owner of the dealership. They want to know if you need assistance.
- If your dealership is unable to resolve the concern, you may contact the Manufacturer's Customer Center.

Any communication to the Manufacturer's Customer Center should include the following information:

- Owner's name and address
- Owner's telephone number (home and office)
- Dealership name
- Vehicle identification number
- Vehicle delivery date and mileage

DaimlerChrysler Motors Corporation Customer Center

P.O. Box 21-8004
Auburn Hills, MI 48321-8004
Phone: (800) 992-1997

DaimlerChrysler Canada Inc. Customer Center

P.O. Box 1621
Windsor, Ontario N9A 4H6
Phone —(800) 465-2001

In Mexico contact:

Av. Prolongacion Paseo de la Reforma, 1240
Sante Fe C.P. 05109
Mexico, D. F.
In Mexico (915) 729-1248 or 729-1240
Outside Mexico (525) 729-1248 or 729-1240

Customer Assistance For The Hearing Or Speech Impaired (TDD/TTY)

To assist customers who have hearing difficulties, the manufacturer has installed special TDD (Telecommunication Devices for the Deaf) equipment at its Customer

Center. Any hearing or speech impaired customer who has access to a TDD or a conventional teletypewriter (TTY) in the United States can communicate with the manufacturer by dialing 1-800-380-CHRY.

Service Contract

You may have purchased a service contract for your vehicle to help protect you from the high cost of unexpected repairs after your manufacturer's new vehicle limited warranty expires. The manufacturer stands behind only the manufacturer's Service Contracts. If you purchased a manufacturer's Service Contract, you will receive Plan Provisions and an Owner Identification Card in the mail within three weeks of your vehicle delivery date. If you have any questions about your service contract, call the manufacturer's Service Contract National Customer Hotline at 1-800-521-9922.

The manufacturer will not stand behind any service contract that is not the manufacturer's Service Contract. It is not responsible for any service contract other than the manufacturer's Service Contract. If you purchased a

service contract that is not a manufacturer's Service Contract, and you require service after your manufacturer's new vehicle limited warranty expires, please refer to your contract documents, and contact the person listed in those documents.

We appreciate that you have made a major investment when you purchased your new vehicle. Your dealer has also made a major investment in facilities, tools, and training to assure that you are absolutely delighted with your ownership experience. You'll be pleased with their sincere efforts to resolve any warranty issues or related concerns.

WARRANTY INFORMATION

See your manufacturer's Warranty Information Booklet for information on warranty coverage and transfer of warranty.

DESCRIPTION	1 Yr/ 12,000	2 Yr/ 24,000	3 Yr/ 36,000	3 Yr/ 50,000	3 Yr/ Unimtd	5 Yr/ 100,000	7 Yr/ 70,000	8 Yr/ 80,000
Basic Limited Warranty Coverage								
Special Extended Warranty Coverage								
Powertrain Limited Warranty (\$100 deductible)				1st Owner & 2nd Owner with Paid Powertrain Transfer				
				2nd Owner if Powertrain Not Transferred and 3rd (And After) Owners				
Anti-Corrosion Perforation Limited Warranty: All Panels								
Outer Panels								
Federal Emission Warranty								
Federal Emission Warranty - Specified Components								
California Emission Warranty								
California Emission Warranty - Specified Components								

NOTE: Vehicles used as a police vehicle, taxi, limousine, postal delivery vehicle, ambulance or rental vehicle are covered only under the 3 year/36,000 mile Basic Limited Warranty. 8132c269

U.S. ONLY

MOPAR® PARTS

Mopar® fluids, lubricants, parts, and accessories are available from your dealer. They will help you keep your vehicle operating at its best.

REPORTING SAFETY DEFECTS

In the 50 United States and Washington D.C.: If you believe that your vehicle has a defect which could cause a crash or cause injury or death, you should immediately inform the National Highway Traffic Safety Administration (NHTSA) in addition to notifying the manufacturer.

If NHTSA receives similar complaints, it may open an investigation, and if it finds that a safety defect exists in a group of vehicles, it may order a recall and remedy campaign. However, NHTSA cannot become involved in individual problems between you, your dealer, and the manufacturer.

To contact NHTSA, you may either call the Auto Safety Hotline toll free at 1-800-424-9393 (or 366-0123 in Washington DC area) or write to: NHTSA, U.S. Dept. of Transportation, Washington DC 20590. You can also obtain other information about motor vehicle safety from the Hotline.

In Canada:

If you believe that your vehicle has a safety defect, you should contact the Customer Service Department immediately. Canadian customers who wish to report a safety defect to the Canadian government should write to Transport Canada, Motor Vehicle Defect Investigations and Recalls, 2780 Sheffield Road, Ottawa, Ontario K1B 3V9.

PUBLICATION ORDER FORMS

To order the following manuals, you may use either the website or the phone numbers listed below. Visa, Mastercard, American Express, and Discover orders are accepted. If you prefer mailing your payment, please call for an order form.

NOTE: A street address is required when ordering manuals. (No P.O. Boxes).

- *Service Manuals.*

These comprehensive service manuals provide the information that students and professional technicians need in diagnosing/troubleshooting, problem solving, maintaining, servicing and repairing DaimlerChrysler Corporation vehicles. A complete working knowledge of the vehicle, system and/or components is written in straightforward language with illustrations, diagrams and charts.

- *Diagnostic Procedure Manuals.*

Filled with diagrams, charts and detailed illustrations, these practical manuals make it easy for students and technicians to find and fix problems on computer-controlled vehicle systems and features. They show exactly how to find and correct problems the first time, using step-by-step troubleshooting and driveability procedures, proven diagnostic tests and a complete list of all tools and equipment.

- *Owner's Manuals.*

These manuals have been prepared with the assistance of service and engineering specialists to acquaint you with specific Chrysler group vehicles. Included are starting, operating, emergency and maintenance procedures as well as specifications, capabilities and safety tips.

Call Toll Free at:

- 1-800-890-4038 (U.S.)
- 1-800-387-1143 (Canada)

Or

Visit us on the World Wide Web at:

- www.techauthority.daimlerchrysler.com
- www.daimlerchrysler.ca/manuals

INDEX

ABS (Anti-Lock Brake) System	165,246	Antenna, Satellite Radio	210
Adding Washer Fluid	156	Antifreeze (Engine Coolant)	357
Adjustable Pedals	132	Anti-Lock Brake System (ABS)	246
Air Cleaner, Engine (Engine Air Cleaner Filter)	323	Anti-Lock Warning Light	165
Air Conditioner Maintenance	325	Anti-Theft System	22,166
Air Conditioning	213	Appearance Care	340
Air Conditioning, Operating Tips	217	Auto Down Power Windows	26
Air Conditioning Refrigerant	326	Automatic Dimming Mirror	73
Air Conditioning System	213	Automatic Door Locks	17
Air Filter	323	Automatic Headlights	113
Air Pressure, Tires	264	Automatic Temperature Control	218
Airbag	37	Automatic Transmission	233,336
Airbag Deployment	49	Adding Fluid	338
Airbag Light	51,65,165	Fluid and Filter Changes	336
Airbag Maintenance	51	Fluid Level Check	337
Alarm	22,166	Fluid Type	336
Alarm System	22	Special Additives	339
Alignment and Balance	268	Torque Converter	238
Alterations/Modifications, Vehicle	8	Autostick	235

Auxiliary Electrical Outlet	148	Break-In Recommendations, New Vehicle	63
Auxiliary Power Outlet	148	Bulb Replacement	350,351
Battery	324	Calibration, Compass	182
Emergency Starting	303	Capacities, Fluid	357
Keyless Transmitter Replacement	21	Caps, Filler	
Saving Feature (Protection)	112	Fuel	281
Belts, Drive	320	Radiator (Coolant Pressure)	331
Belts, Seat	28	Car Washes	341
Body Mechanism Lubrication	327	Carbon Monoxide Warning	64,140,280
B-Pillar Location	259	Cargo Area Cover	151
Brake System	334	Cargo Area Features	150
Anti-Lock	246	Cargo Compartment	150
Hoses	335	Light	150
Master Cylinder	335	Luggage Carrier	157
Parking	244	Cargo Light	150
Trailer Towing	284	Cargo Load Floor	154
Warning Light	164	Cargo Tie-Downs	153
Brake/Transmission Interlock	234	Carpeting	343

Catalytic Converter	321	Console, Overhead	137
Caution, Exhaust Gas	140	Contract, Service	386
CD Player	186,200	Converter, Catalytic	321
Cellular Phone	76	Cooling System	329
Center High Mounted Stop Light	356	Adding Coolant (Antifreeze)	331
Chains, Tire	275	Coolant Capacity	357
Changing A Flat Tire	298	Coolant Level	332
Chart, Tire Sizing	256	Disposal of Used Coolant	332
Checks, Safety	65	Drain, Flush, and Refill	330
Child Restraint	53,54,59,61	Inspection	329
Child Restraint Tether Anchors	58,59	Points to Remember	333
Child Safety Locks	16	Pressure Cap	331
Climate Control	213	Radiator Cap	331
Clock	188	Selection of Coolant	330,357
Compact Disc Maintenance	212	Crankcase Emission Control System	323
Compass	178,182	Cruise Control (Speed Control)	134
Compass Calibration	182	Cruise Light	169
Compass Variance	183	Cup Holder	149
Computer, Trip/Travel	178	Customer Assistance	384

Data Recorder, Event	51	Drive Belts	320
Daytime Running Lights	115	Driving	249
Dealer Service	316	Off-Pavement	250
Defroster, Rear Window	214	Off-Road	250
Defroster, Windshield	65,215,222	Electric Remote Mirrors	75
Diagnostic System, Onboard	313	Electrical Outlet, Auxiliary	148
Dimmer Switch, Headlight	116	Electronic Speed Control	134
Dipsticks		Electronic Stability Program	124
Automatic Transmission	337	Electronic Throttle Control Warning Light	170
Oil (Engine)	316	Electronic Vehicle Information Center	168,171
Power Steering	326	Emergency, In Case of	
Disabled Vehicle Towing	306	Freeing Vehicle When Stuck	238
Disposal		Hazard Warning Flasher	296
Engine Oil	320	Jacking	298
Used Engine Fluids	320	Jump Starting	303
Door Locks	15	Tow Hooks	305
Door Locks, Automatic	17	Emission Control System Maintenance	314,362
Door Opener, Garage	138		
Doors	15		

Engine	
Air Cleaner	323
Block Heater	232
Break-In Recommendations	63
Compartment	311
Cooling	329
Exhaust Gas Caution	64,280
Fails to Start	231
Flooded, Starting	231
Fuel Requirements	277,357
Jump Starting	303
Oil	316,357
Oil Change Interval	317
Oil Disposal	320
Oil Filter	320
Oil Filter Disposal	320
Oil Selection	357
Overheating	297
Starting	230
Temperature Gauge	167
Engine Oil Viscosity	319
Engine Oil Viscosity Chart	319
Enhanced Accident Response Feature	50
Entry System, Illuminated	15
Event Data Recorder	51
Exhaust Gas Caution	64,280
Exhaust System	328
Exterior Finish Care	341
Filters	
Air Cleaner	323
Engine Fuel	323
Engine Oil	320
Finish Care	341
Flashers	296
Hazard Warning	296
Turn Signal	164,353,355
Flipper Glass, Tailgate	24

Flooded Engine Starting	231	Filler Door	281
Fluid Capacities	357	Filter	323
Fluid Leaks	66	Gasoline	277
Fluid Level Checks		Gauge	169
Automatic Transmission	336,337	Materials Added	279
Engine Oil	316	Octane Rating	277
Power Steering	326	Requirements	357
Fog Light Service	354	Tank Capacity	357
Fog Lights	116,170,354	Fuel System Caution	279,282
Folding Rear Seat	103	Fuses	345
Four Wheel Drive	239	Garage Door Opener	138
Operation	239	Gas Cap	281,313
Systems	239	Gasoline	277
Four Wheel Drive Operation	239	Gasoline, Reformulated	278
Four-Way Hazard Flasher	296	Gasoline/Oxygenate Blends	278
Freeing A Stuck Vehicle	238	Gauges	
Front Axle	340	Coolant Temperature	167
Fuel	277	Fuel	169
Filler Cap	281		

Speedometer	164	Holder, Cup	149
Tachometer	166	Homelink Transmitter	138
Gear Ranges	234	Hood Release	110
General Information	20,275	Hoses	334
Glass Cleaning	343	Identifying Your Engine	311
Hands-Free Phone	76	Ignition	
Hazard Warning Flasher	296	Key	11
Head Restraints	101	Illuminated Entry	15
Head Rests	101	Infant Restraint	53,54
Headlights	113	Inflation Pressure Tires	264
Bulb Replacement	351	Information Center, Vehicle	171
On With Wipers	113	Inside Rearview Mirror	72
Replacing	351	Instrument Cluster	163,164
Heated Mirrors	74	Instrument Panel and Controls	162
Heated Seats	102	Integrated Power Module	348
Heater, Engine Block	232	Interior Appearance Care	342
High Beam Indicator	164	Interior Fuses	345
High Beam/Low Beam Select (Dimmer) Switch	116	Interior Lighting	111

Interior Lights	111,115	Lead Free Gasoline	277
Intermittent Wipers	118	Leaks, Fluid	66
Introduction	4	Liftgate	23
Jack Location	298	Liftgate Flipper Glass	24
Jack Operation	298,300	Liftgate Window Wiper/Washer	155
Jacking Instructions	300	Lights	65,111
Jump Starting	303	Airbag	51,165
Key, Programming	14	Alarm	65
Key, Replacement	13	Anti-Lock	165
Key, Sentry	12	Automatic Headlights	113
Key-In Reminder	12	Back-Up	355
Keyless Entry System	18	Battery Saver	112
Keys	11	Brake Warning	164
Lap/Shoulder Belts	28	Bulb Replacement	351
LATCH		Cargo	150
(Lower Anchors and Tether for CHildren)	58,59	Center Mounted Stop	356
		Cruise	169
		Daytime Running	115
		Dimmer Switch, Headlight	112,116

Electronic Throttle Control Warning	170	Rear Tail	355
Fog	116,170,354	Seat Belt Reminder	169
Four-Wheel Drive Indicator	168	Service	351
Fuses	345	Service Engine Soon (Malfunction Indicator)	164
Hazard Warning Flasher	296	Side Marker	355
Headlight Switch	113	Tow/Haul Indicator	168
Headlights	351	Traction Control	166
Headlights On With Wipers	113	Turn Signal	112,116,353,355
High Beam Indicator	164	Vanity Mirror	76
Instrument Cluster	113,115	Voltage	170
Interior	111,115	Load Floor, Cargo	154
Lights On Reminder	115	Loading Vehicle	
Low Tire	167	Tires	259
Malfunction Indicator	164	Locks	15
Map Reading	111	Automatic Door	17
Oil Pressure	166	Child Protection	16
Passing	116	Door	15
Reading	111,137	Liftgate, Tailgate	15
Rear Servicing	355	Power Door	17

Lower Anchors and Tether for CHildren (LATCH)	58,59	Automatic Dimming	73
Lubrication, Body	327	Electric Powered	75
Luggage Rack	157	Electric Remote	75
Lumbar Support	101	Exterior Folding	74
Maintenance Free Battery	324	Heated	74
Maintenance Procedures	316	Outside	74
Maintenance Schedule	362	Rearview	72
Schedule "A"	376	Vanity	76
Schedule "B"	365	Modifications/Alterations, Vehicle	8
Maintenance Schedules	362	Monitor, Tire Pressure System	269
Malfunction Indicator Light	164,314	Mopar Parts	315,388
Manual, Service	389	Multi-Displacement Engine System	254
Master Cylinder	335	Multi-Function Control Lever	112
Memory Seat	75,106	New Vehicle Break-In Period	63
Memory Seats and Radio	106	Occupant Restraints	27
Mini-Trip Computer	180	Octane Rating, Gasoline	277
Mirrors	72	Odometer	168

Trip	168	Overheating, Engine	168,297
Off-Pavement Driving	250,344	Owner's Manual	389
Off-Road Driving	250,344	Paint Care	340
Oil, Engine	316	Paint Damage	340
Capacity	357	Panic Alarm	19
Change Interval	317	Park Assist System, Rear	127
Dipstick	316	Parking Brake	244
Filter	320	Passing Light	116
Identification Logo	319	Pedals, Adjustable	132
Materials Added to	320	Pets	63
Pressure Warning Light	166	Pets, Transporting	63
Recommendation	318,357	Phone, Cellular	76
Viscosity	319,357	Phone, Hands-Free	76
Onboard Diagnostic System	313,314	Placard, Tire and Loading Information	260
Opener, Garage Door	138	Polishing and Waxing	341
Outside Rearview Mirrors	74	Power	
Overdrive	236	Distribution Center	346
Overdrive OFF Switch	236	Door Locks	17
Overhead Console	137		

Mirrors	75	Rear Axle	340
Outlet	148	Rear Cup Holder	149
Seats	102	Rear Liftgate	15
Steering	326	Rear Park Assist System	127
Sunroof	145	Rear Seat, Folding	103
Windows	25	Rear Window Defroster	214
Pregnant Women and Seat Belts	35	Rear Window Features	155
Preparation for Jacking	300	Rear Wiper/Washer	155
Pretensioners		Rearview Mirrors	72
Seat Belts	34	Reclining Front Seats	100
Programmable Electronic Features	139,143,174	Recommended Fluids, Lubricants and Genuine	
Programming Transmitters	139,143	Parts	358
Radial Ply Tires	266	Recorder, Event Data	51
Radio Broadcast Signals	184	Recreational Towing	290
Radio Operation	186,200,213	Shifting into Transfer Case Neutral (N)	290
Radio, Satellite	207	Shifting out of Transfer Case Neutral (N)	292
Radio (Sound Systems)	186,200	Reformulated Gasoline	278
Rain Sensitive Wiper System	119	Refrigerant	326
		Reminder, Lights On	115

Reminder, Seat Belt	34	Satellite Radio Antenna	210
Remote Keyless Entry	18	Schedule, Maintenance	362
Remote Sound System Controls	211	Seat Belt Maintenance	65
Replacement Bulbs	350	Seat Belt Reminder	34
Replacement Tires	267	Seat Belts	28
Reporting Safety Defects	388	Adjustable Upper Shoulder Anchorage	32
Restraints, Child	53	And Pregnant Women	35
Restraints, Occupant	27	Child Restraint	53,61
Retractable Cargo Area Cover	151	Extender	36
Rocking Vehicle When Stuck	238	Front Seat	28
Roof Type Carrier	157	Inspection	65
Rotation, Tires	276	Maintenance	65
		Pretensioners	34
Safety Checks Inside Vehicle	65	Reminder	169
Safety Checks Outside Vehicle	65	Shoulder Belt Anchorage	32
Safety Defects, Reporting	388	Seats	99
Safety Information, Tire	254	Adjustment	99
Safety Tips	64	Head Restraints	101
Satellite Radio	207	Heated	102

Lumbar Support	101	Signals, Turn	116,164,353,355
Memory	106	Snow Chains (Tire Chains)	275
Power	102	Snow Plow	293
Rear Folding	103	Spare Tire	299
Reclining	100	Spark Plugs	321
Security Against Theft	15	Specifications	
Security Alarm (Theft Alarm)	22,166	Fuel	277
Selection of Oil	318	Oil	318
Sentry Key	12	Speed Control	134
Sentry Key Programming	14	Speedometer	164
Sentry Key Replacement	13	Starting	230
Service Assistance	384	Automatic Transmission	230
Service Contract	386	Cold Weather	231,232
Service Engine Soon Light (Malfunction Indicator)	164	Emergency (Jump Starting)	303
Service Manuals	389	Engine Block Heater	232
Setting the Clock	188,202	Engine Fails to Start	231
Shifting		Steering	
Automatic Transmission	233	Power	326
Shoulder Belts	28	Wheel, Tilt	120

Steering Wheel Mounted Sound System		
Controls	211	
Storage	350	
Storage, Behind the Seat	151	
Storage Bin	151	
Storage Compartment, Center Seat	105	
Storage, Vehicle	224,350	
Storing Your Vehicle	350	
Sun Roof	145	
Sunglass Storage	137	
Supplemental Restraint System - Airbag	37	
Tachometer	166	
Temperature Control, Automatic	218	
Temperature Gauge, Engine Coolant	167	
Tether Anchor, Child Restraint	58	
Tie Down Hooks, Cargo	153	
Tilt Steering Column	120	
Time Delay, Headlight	117	
Tire and Loading Information Placard	259,260	
Tire Identification Number (TIN)	258	
Tire Markings	254	
Tire Safety Information	254	
Tires	65,263	
Air Pressure	264	
Alignment and Balance	268	
Chains	275	
Changing	298	
General Information	263	
High Speed	265	
Inflation Pressures	264	
Jacking	298	
Load Capacity	259,260	
Pressure Monitor System	269	
Pressure Warning Light	167	
Radial	266	
Replacement	267	
Rotation	276	

Safety	65,254	Trailer and Tongue Weight	285
Sizes	256	Warnings	284
Spare Tire	299	Wiring	286
Spinning	266	Transfer Case	339
Tread Wear Indicators	267	Maintenance	339
Wheel Mounting	302	Transmission	
Tongue Weight/Trailer Weight	285	Automatic	233,336
Torque Converter Clutch	238	Maintenance	336
Tow Hooks, Emergency	305	Range Indicator	169
Tow/Haul Indicator Light	168	Shifting	233
Towing	283,306	Transmitter Battery Service	21
Disabled Vehicle	306	Transmitter, Garage Door Opener	138
Recreational	290	Transmitter, Remote Keyless Entry	18
Traction Control	121	Tread Wear Indicators	267
Traction Control Light	121,166	Turn Signals	116,164,353,355
Traction Control Switch	121	Underhood Fuses	346,348
Trailer Towing	283	Universal Transmitter	138
Cooling System Tips	287	Upholstery Care	342
Tips	287		

408 INDEX

Vacuum/Vapor Harnesses	334	Washing Vehicle	341
Vanity Mirrors	76	Waxing and Polishing	341
Variance, Compass	183	Wheel Alignment and Balance	268
Vehicle Identification Number	7	Wheel Mounting	302
Vehicle Loading	260	Wind Buffeting	26,147
Vehicle Modifications/Alterations	8	Window Fogging	216,225
Vehicle Storage	224,350	Windows	
Vinyl Trim	342	Power	25
Viscosity, Engine Oil	319	Windshield Defroster	65,215,222
Warning Flasher, Hazard	296	Windshield Washers	117
Warnings and Cautions	6	Fluid	328
Warranty Information	386	Windshield Wiper Blades	327
Washer, Adding Fluid	156	Windshield Wipers	117
Washers, Windshield	117,328	Wipers, Intermittent	118
		Wipers, Rain Sensitive	119